

EXPEDIENT



Handgun
AMMO

HOMEMADE

If old grandpa left you his old 12 gauge, or you want to shoot that old pistol you came across while cleaning the attic (and don't have any ammo!) what do you do? If you can't buy ammo, or even primers and re-loading presses from a store, what do you do?? You will need to start from scratch!

Expedient Homemade Ammo provides all the info' you need to make simple effective ammo. At the end of the day, you don't need 'Presses or Primers' to construct you own improvised ammo with just a few simple tools !



Expedient Homemade Handgun Ammo

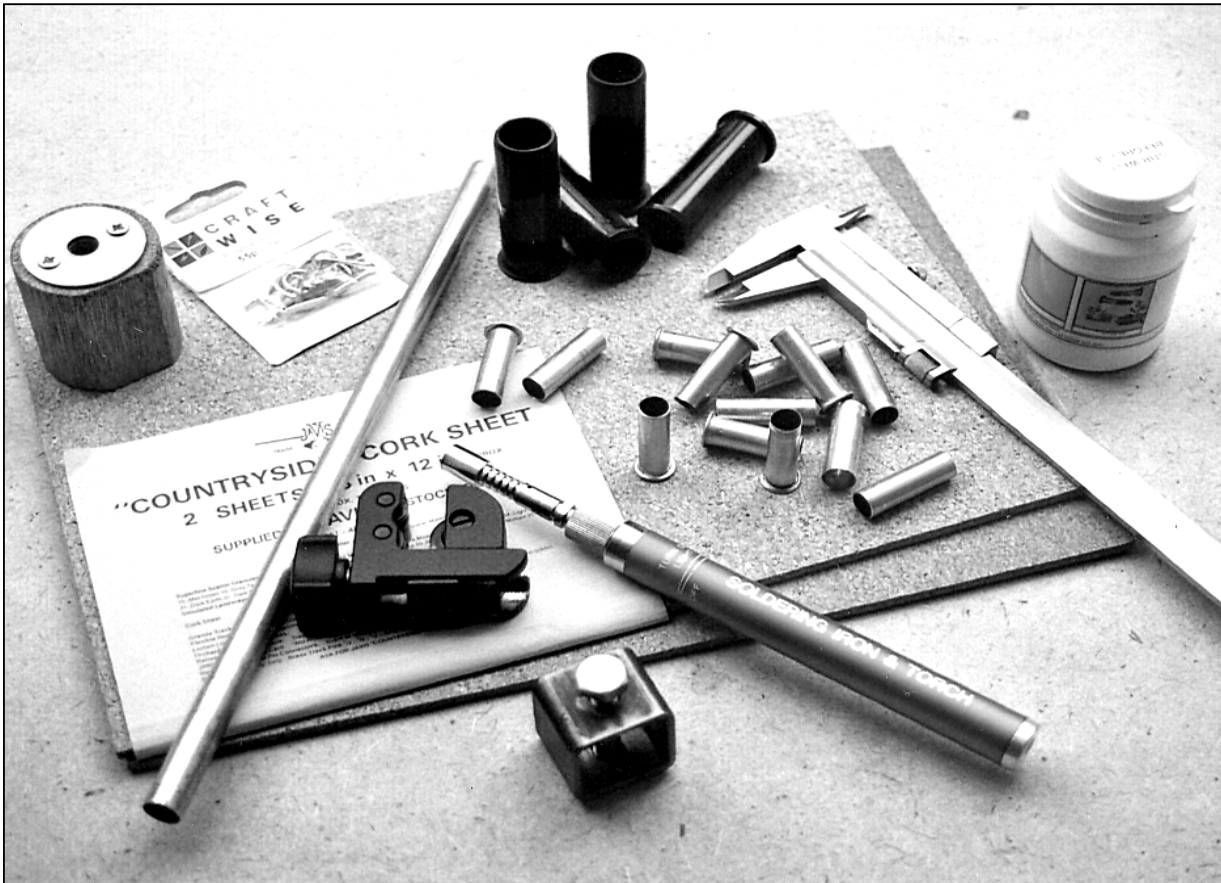

MATERIALS REQUIRED

- 1) Brass tube.**
- 2) Curtain rings.**
- 3) Solder paint.**
- 4) Tube cutter.**
- 5) Vernier gauge.**
- 6) Gas torch.**
- 7) 30 x 30mm Square tube.**
- 8) Hardwood section.**
- 9) Attention to detail.**

Expedient Homemade Handgun Ammo

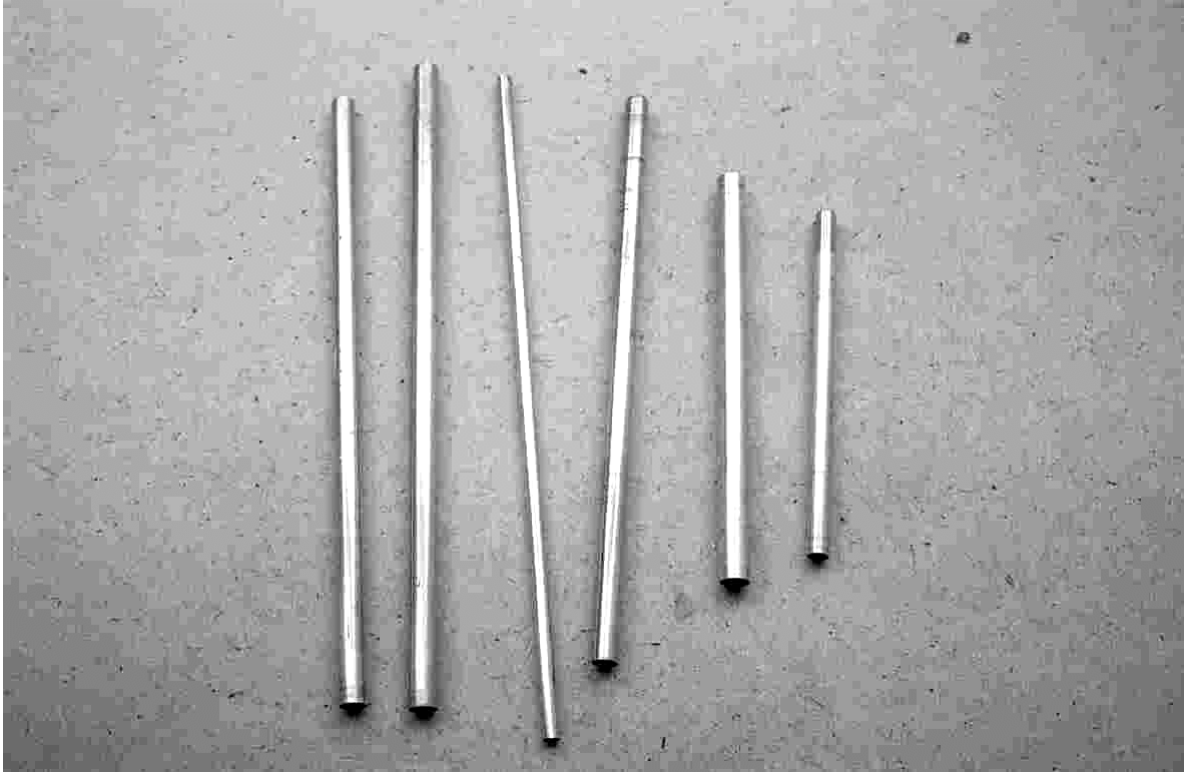

We will start by manufacturing .38 Special cartridge cases.

The .38 Special is one of the most popular revolver cartridges in the world, supplying ammunition to a countless array of handguns, so it seems the appropriate cartridge to start with.

To manufacture our homemade .38 cartridges we require some lengths of thin walled brass tube. This material is readily available from most good hobby and craft shops. The tubing I am using is manufactured in the U.S.A. For the various calibre of ammunition we will construct in this book we require tube in the following sizes;

15/32" - 13/32" - 3/8" - 7/16" - and 11/32".

For the .38 cartridge case a length of 3/8" tube is required. The vernier gauge is set to 30mm, and as shown in the photos below, used to scribe a line around the tube. This is achieved by simply rotating the tube against the sharp point of the gauge.

This section of tube, measuring 30mm, is now removed. The scribe mark is the point at which the tube is cut. Brass tube is harder to cut than ordinary copper plumbing tube so a good quality plumbers tube cutter is required. I emphasize 'good quality'. It is perfectly possible to buy a good quality cutter for around £10. It is well worth spending an extra few pounds as it will make tube cutting an easier prospect.

Expedient Homemade Handgun Ammo

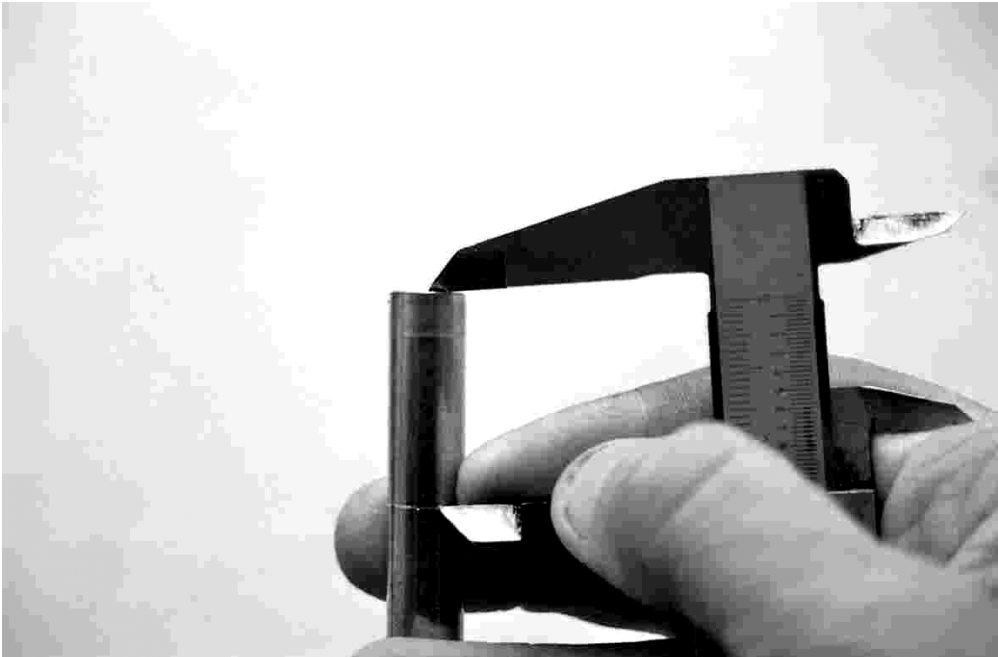

Mark the tube.

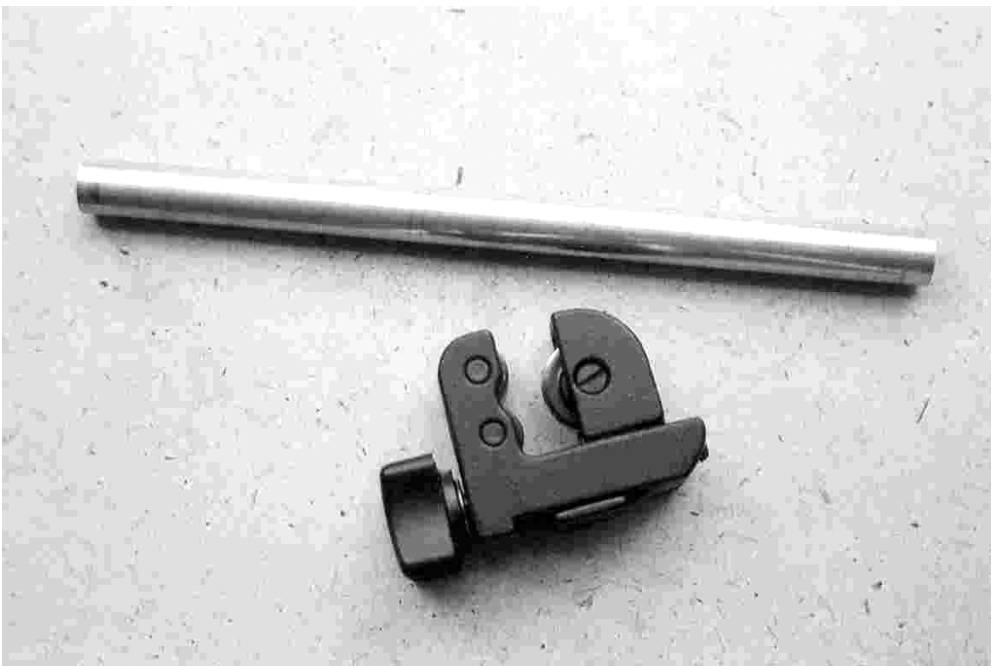

Cut the tube.

The tube cutter should be carefully rotated clockwise and anti-clockwise so as to allow the section of tube we require to be removed. It is important not to rush the tube cutting procedure as this may cause the cutting wheel to wander leading to an inaccurately cut case.

Expedient Homemade Handgun Ammo



Square the case end.

It is of *great importance* to ensure that one end of the tube section (from here on referred to as the case) is perfectly square. To achieve this the case is placed in a drill press and the spinning case lowered onto a flat file, as illustrated in the above photo. It should be noted that the drill chuck should be tightened by hand only so as not to distort the roundness of the case. This method of case trimming is just as accurate as using a small lathe and no different in principle to the case trimmers used in conventional re-loading practices.

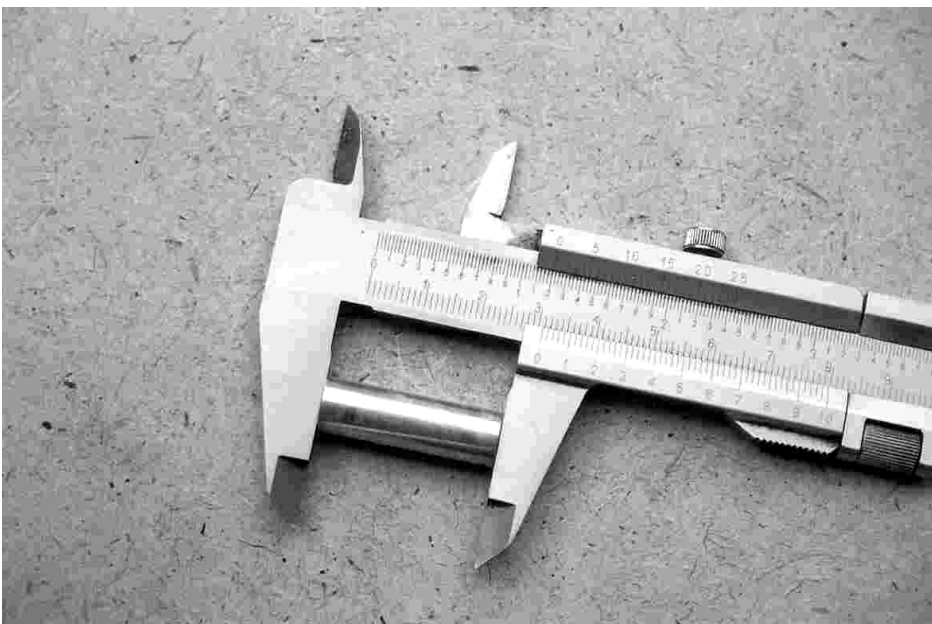

Measure the case.

Expedient Homemade Handgun Ammo

Following the trimming operation the case is measure to ensure it has an overall length of 29mm. The correct case length is very important.

ATTACHING THE CASE RIM



Soldering materials.



Case rims

Now that we have the main body of our .38 case it is necessary to attach the case rim. To achieve this we require a small 'micro' pencil gas torch, a 3/8" curtain ring, and some solder paint. Solder paint is a mixture of flux and powdered lead solder.

Expedient Homemade Handgun Ammo

The .38 case rim consists of a 3/8" curtain ring. These can be found in most good hobby and craft shops and usually have 'Rings and Clips' printed on the pack. The clips should be discarded as they are not required. It is very important to make sure the rings have an inside diameter of 3/8".

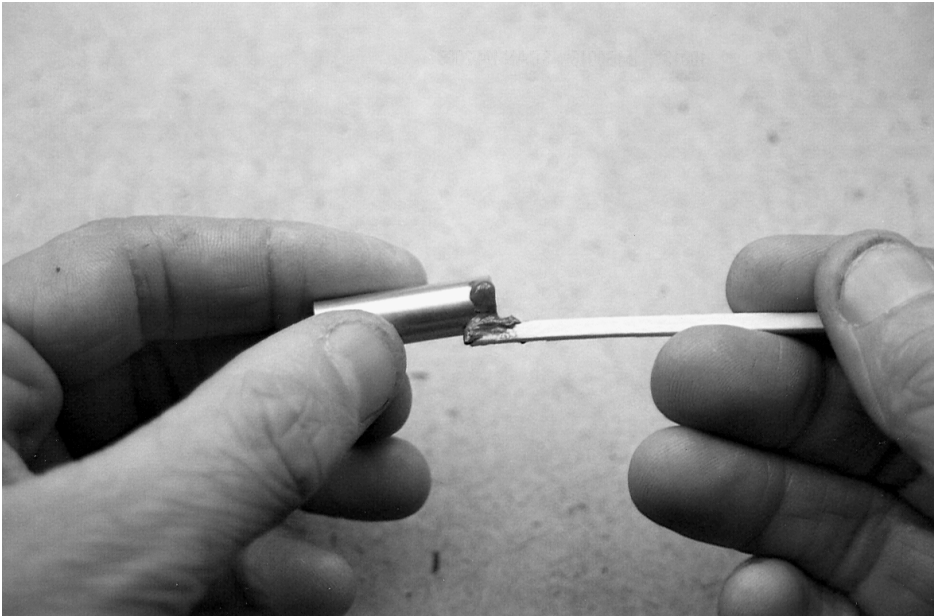

Apply the solder.

A matchstick or small artists paintbrush is used to apply a small amount of solder paint to the *squared end of the case*. Ensure that the solder is fully covering the circumference of the case.



Solder the rim.

Expedient Homemade Handgun Ammo

The ring is now placed in the centre of a section of steel rod, around 1" in diameter, as shown above. The painted end of the case is then inserted into the ring. It must be ensured that the case is inserted fully and the end of the case resting against the top of the rod. The pencil torch is now used to solder the ring to the case. Only a small amount of heat is required to melt the solder so it is important not to "over do it". Allow the case to cool for thirty seconds or so and then carefully remove the case and place it to one side while the next case is soldered.

CASE CLEAN UP



File the base.



De- burr the case.

Expedient Homemade Handgun Ammo

As illustrated above, the case must be passed back and forth across the surface of a file several times to remove any solder residue. The inside of the case mouth must also be completely de-burred using a knife.



A collection of finished cases.

For the simple manufacture of moderate quantities of .38 cases, the tube and ring method is perhaps ideal for the hobby gunsmith. Once the necessary quantity of tube sections are cut and trimmed to their correct length, cases can be manufactured quite quickly.

PRIMING THE CASES

In the event of having to manufacture our own cartridge cases it is highly likely we will also have to utilise an unconventional method of priming the cases. Without the primer the cartridge cannot be made. This book illustrates the improvised method of case manufacture, so we will take similar liberties in respect of the primer.

If primers are unavailable, we can make good use of the blank cartridge as a priming method. I am using the well-known and widely available 8mm Fioocchi blanks for this reason.

The blank must be disassembled before it may be used to prime our .38 cases. This is a simple procedure involving the removal of the blanks tip and green plastic plug liner, leaving us with a primed empty 8mm case.



The fioochi 8mm blank case is actually manufactured from *steel* as apposed to conventional brass. The blanks are used in a wide array of blank firing pistols for re- enactments and training purposes where a real firearm would be unwise, or just general fun usage by replica gun collectors. They are a strong and reliable method of priming the improvised cartridge case.

Expedient Homemade Handgun Ammo



Remove the blank tip.

The first step is to use a tube cutter to remove the tip of the blank. It will be necessary to hold the blank in a pair of pliers to do this as the blank is a small component. Once the tube cutter has cut through the case wall, both ends of the blank are gripped in pliers and both halves pulled apart. In doing so the green plastic insert will be removed. The section containing the green plastic plug is discarded.

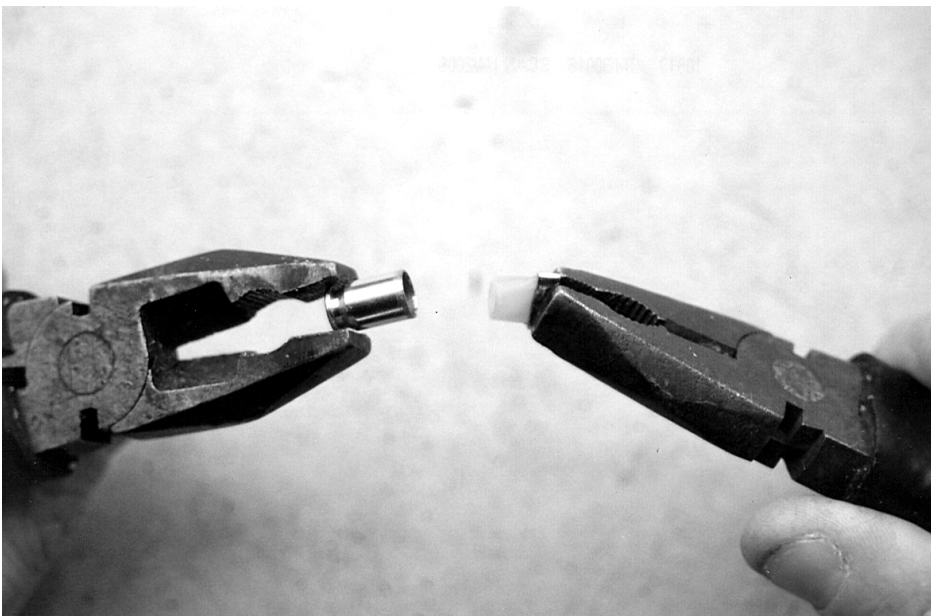

Pull the blank apart.

A bit of twisting and pulling will be required to separate the two halves but this is not difficult. The above photo shows the tip removed.

Expedient Homemade Handgun Ammo

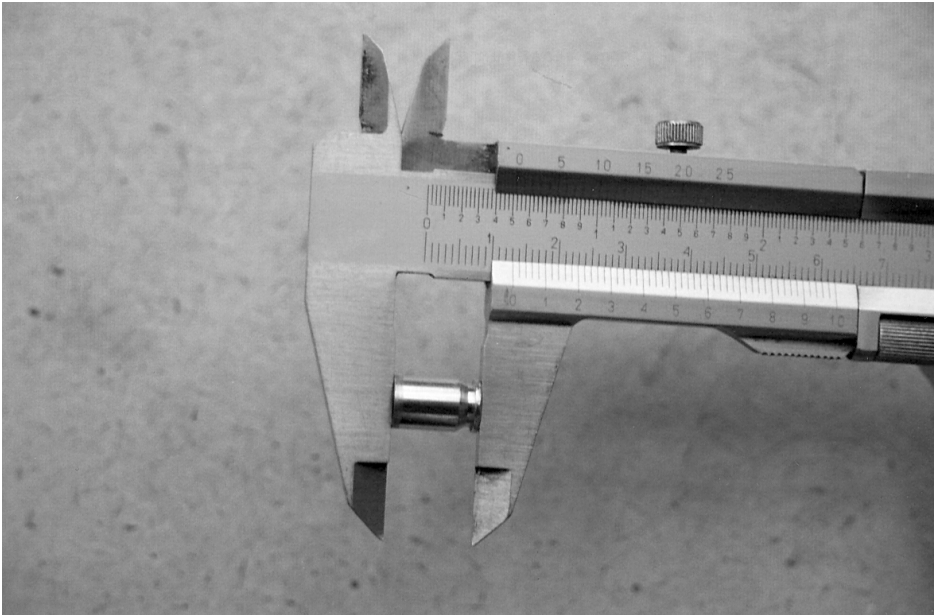

Measure the blank.

The blank can now be measured. It should be somewhere between 13mm and 15mm in length. The exact length not being too important. Before we can use the blank cases to prime our .38 cases we must make a small brass sleeve insert, so as to permit the blank to fit the .38 case. For this sleeve we require a simple 15mm length of 11/32" brass tube.



Measure the sleeve.

A 15mm, or thereabouts, length of 11/32" brass tube is cut and measured, as shown above. The tube just acts as a 'filler' between the outer diameter of the blank and the inside diameter of our .38 case.

Expedient Homemade Handgun Ammo

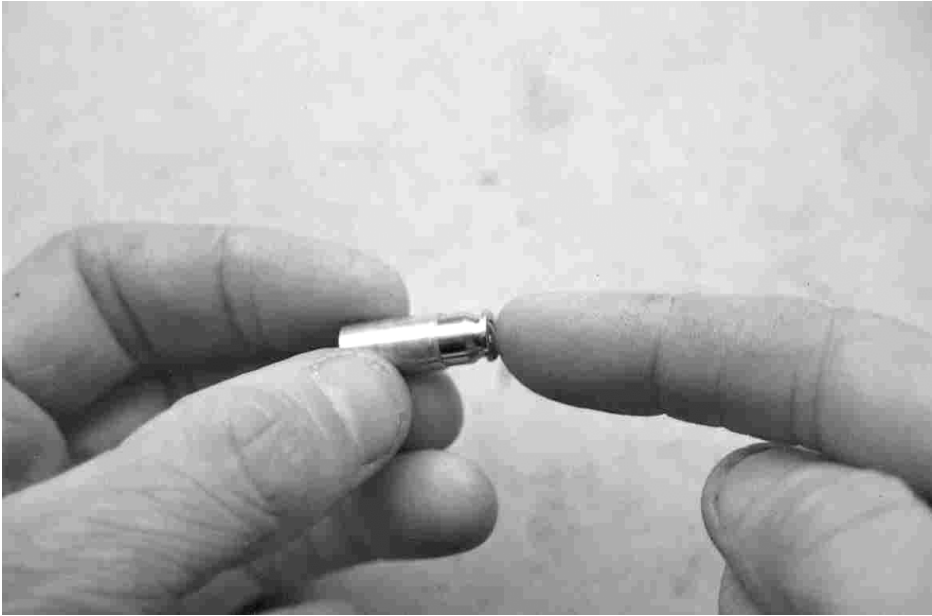

Press the blank into the sleeve.

After de-burring one end of the sleeve we can bond the blank and sleeve together. The outside of the sleeve is coated with a high strength retainer such as 'bearing adhesive' and the blank inserted into the sleeve. Do not use 'Super Glue'.



Insert the priming assembly into the case.

The blank and sleeve priming assembly can now be inserted into our .38 case. Retainer is now applied to the outer circumference of the sleeve and the assembly inserted into the .38 case, as shown in the above photo.

Expedient Homemade Handgun Ammo



The primed case.

The above photo shows our newly primed case with the priming assembly in place. At each point of inserting the *blank into the sleeve* and the *sleeve and blank* into the case, the base of each assembly should be placed against a flat surface to ensure all inserts are completely flush with each other. The primed case must now be put to one side while the retainer has time to harden. We may use this “drying time” to prime more cases.

THE SHELL HOLDER

Before our newly primed cases can be charged with powder it is necessary to make a simple shell holder. To make the shell holder we require two washers. Both washers are 1" in diameter. One washer must have a 1/4" hole and the second a 1/2" hole. The two washers must be soldered together and for this we require some solder paint and our gas torch. Again, I am using a pencil torch due to its small size and more accurate flame. The photo below shows the complete shell holder and a handmade .38 case ready for loading.



Shell holder materials.

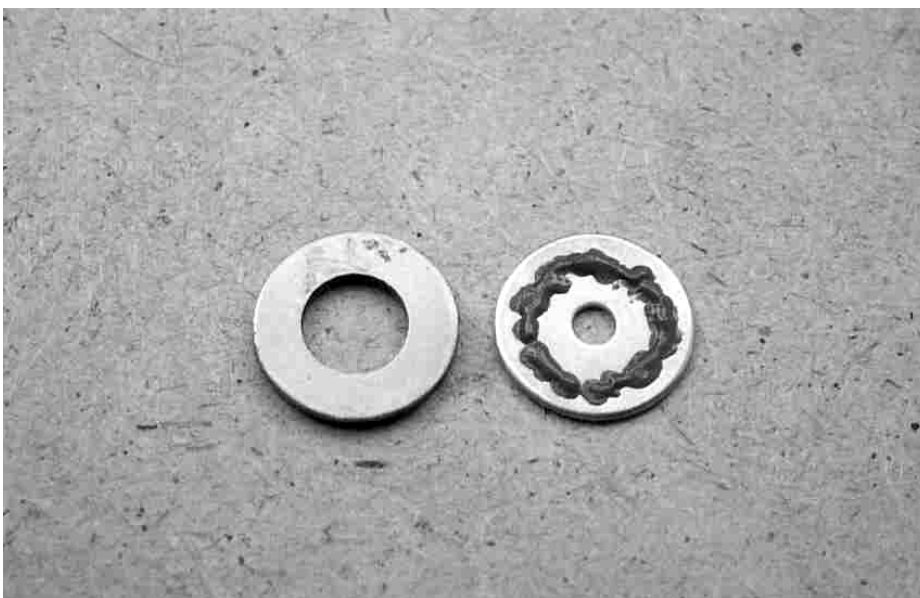

Washers ready to solder.

Expedient Homemade Handgun Ammo

Before the washers can be soldered together the zinc surface should be removed by simply sliding the washers over a file several times.

To solder the two washers together place the washer with the ¼" hole on a flat surface and apply solder paint to it's circumference. Place the second washer (½" hole) on top of the first. Apply heat to the washers until the solder runs. Now leave the assembly to cool. If, as sometimes occurs, the washers 'slide' out of alignment with each other during soldering, the washers may be soldered on a wooden board and four tacks may be used to hold the washers in alignment. Simply place a tack at the 12, 3, 6, and 9 o'clock points around the washers. The wooden surface allows the tacks to be pressed in by finger pressure only and permits their easy removal after soldering. The small amount of heat required will not burn the wood unduly but it's best not to use the best dining room table !



Soldering the shell holder.

In the above photo I am soldering the washers together on top of a section of steel tube, but as pointed out earlier, it is sometimes easier to use the board and tack method. The purpose of the shell holder is to protect the primer in the base of the case from coming into contact with any object that may cause the primer to detonate unintentionally.

It is of great importance when reloading ammunition and although it is a very simple component it's importance should not be overlooked.

The photo below shows the finished shell holder and case ready for loading with powder and bullet.

The next step is to resize our bullets ready for loading.

Expedient Homemade Handgun Ammo



BULLET SIZING DIE

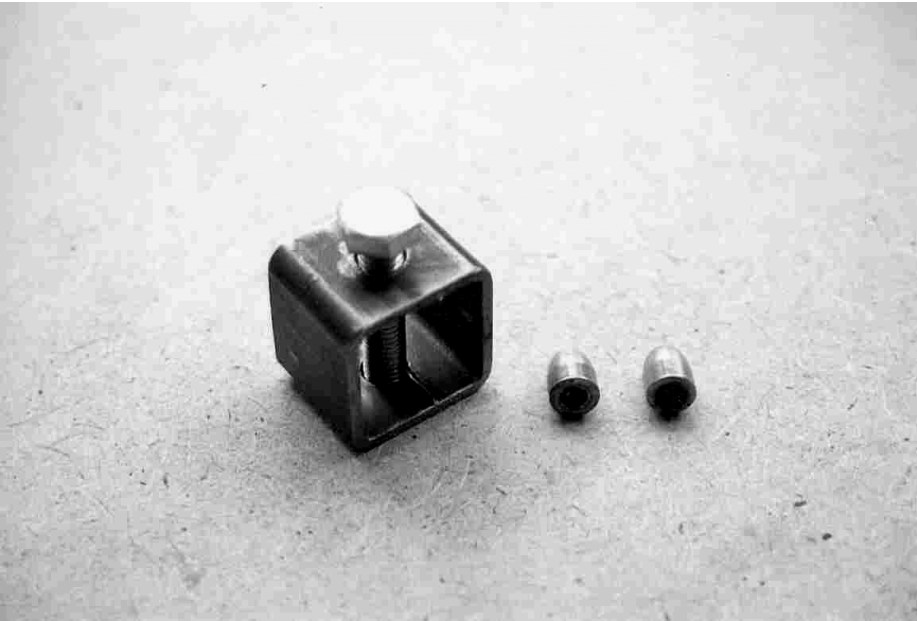

The bullet sizing die.

I am using commercially available .38 bullets for my improvised cartridges simply because they are readily available, but even if they were not a bullet mould can easily be acquired and bullets cast. Due to the wall thickness of our brass tube (thicker than that of a factory manufactured case) we cannot seat 'off the shelf' bullets without first re-sizing them to fit our handmade cases. For this purpose we must make a very simple sizing die to re-size our bullets to the correct diameter.



Drilling the die holes.

Expedient Homemade Handgun Ammo

The homemade re-sizing die is nothing more than a modified section of box section tubing. I am using 30 x 30mm tube with a wall thickness of 2.5mm. The length of the tube is also 30mm, just to keep things simple. For accuracy of drilling a drill press must be used to make the die. The first step is to drill a 2mm or 3mm pilot hole through the centre of the tube section. The hole must pass through both walls. Next, the hole is enlarged to 5mm or 6mm, and then the final 8.9mm hole is drilled (carefully and slowly) again making sure the drill passes through both walls. The holes can be made by simply holding the tube section on the drill table with your hand and drilling the holes. It is not necessary to clamp the tube or hold it in a vice.

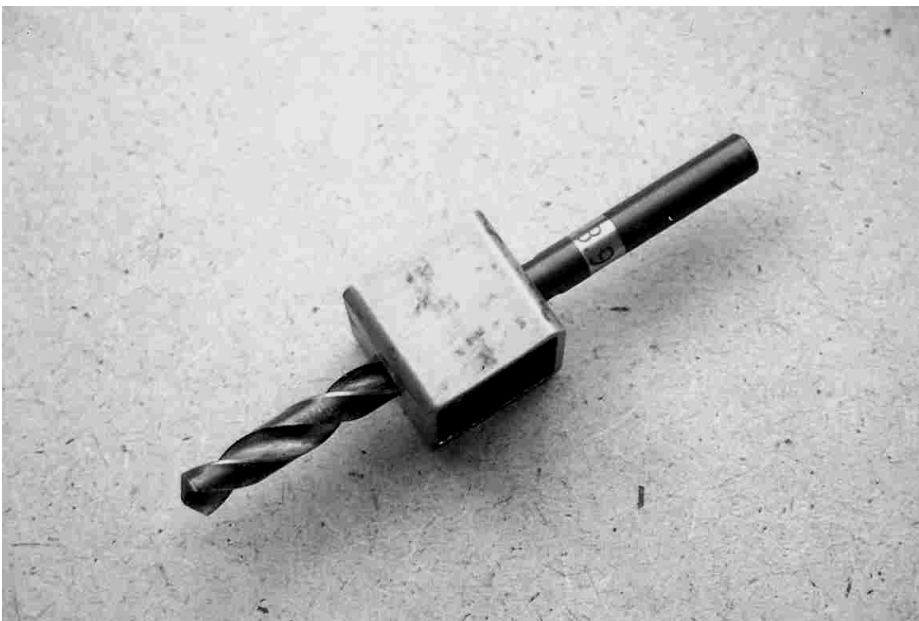

Drill the tube.



Solder the nut.

Expedient Homemade Handgun Ammo

We now have the main body of a simple sizing die through which to pass our bullets.

The next step is to simply solder an 8mm (M8) nut to the inside wall of the die in alignment with one of the holes, as shown in the above photo.

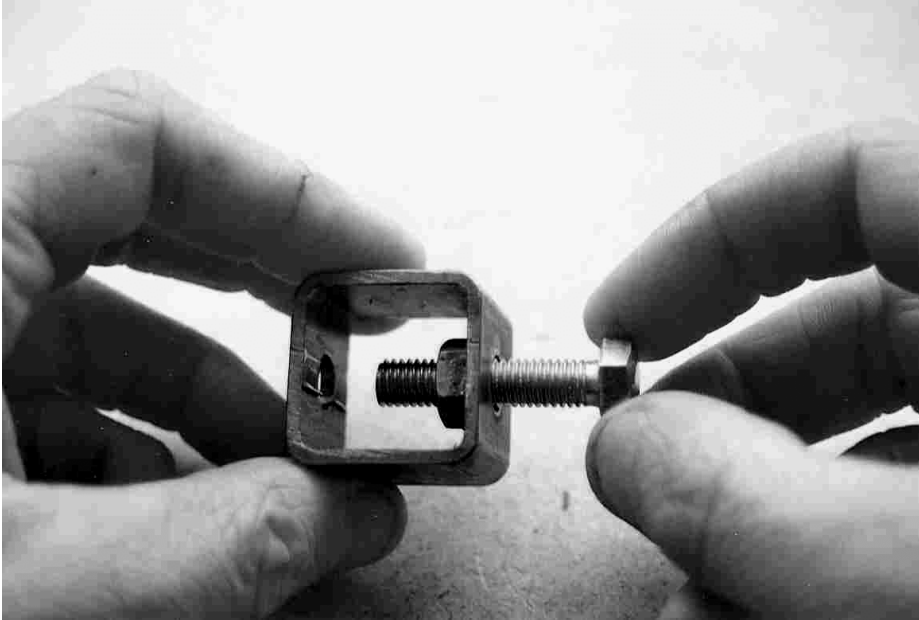

Screw in the die bolt.

An 8mm bolt, 2" in length, is now screwed into the die. It should screw freely in and out. The bolt allows us to press the bullet through the opposite hole.

The finished die is shown below.



The finished die tool.

Expedient Homemade Handgun Ammo

We must re-size our bullets to a diameter of 8.9mm in order for them to fit into our .38 cases. This diameter of bullet is obviously less than any factory made or home cast bullet, but still of sufficient diameter to engage the riffling of any .38 calibre handgun. Just as with our cases, we must compromise to get the job done.

In the photo below I am sizing 9mm jacketed bullets because they are as near to the diameter we require as bought (9mm - .356") and less sizing will be required as a result. You can of course re-size any .38 *lead* bullet (.358" – 9.09mm) and from a re-sizing standpoint any lead bullet is easier to size than the jacketed variety. I am using jacketed bullets simply because that is what was available at the time of writing but it does illustrate that even the hard case of the jacketed bullet can be sized using this simple device.

To size the bullet , place the bullet in the die as shown in the photo below and, using a spanner, slowly tighten the bolt.



**Press the
bullet through
the die.**

Screwing the bolt in will drive the bullet through the opposite hole sizing the bullet to a diameter of 8.9mm. I would suggest sizing perhaps fifty or so bullets in one session so as to have a ready supply.

BULLET SEATING DIE



The bullet seating die.

Now that we have our supply of resized bullets we can begin the reloading process and start seating bullets into our cases. But before this can be done a simple 'bullet seating die' must be made.

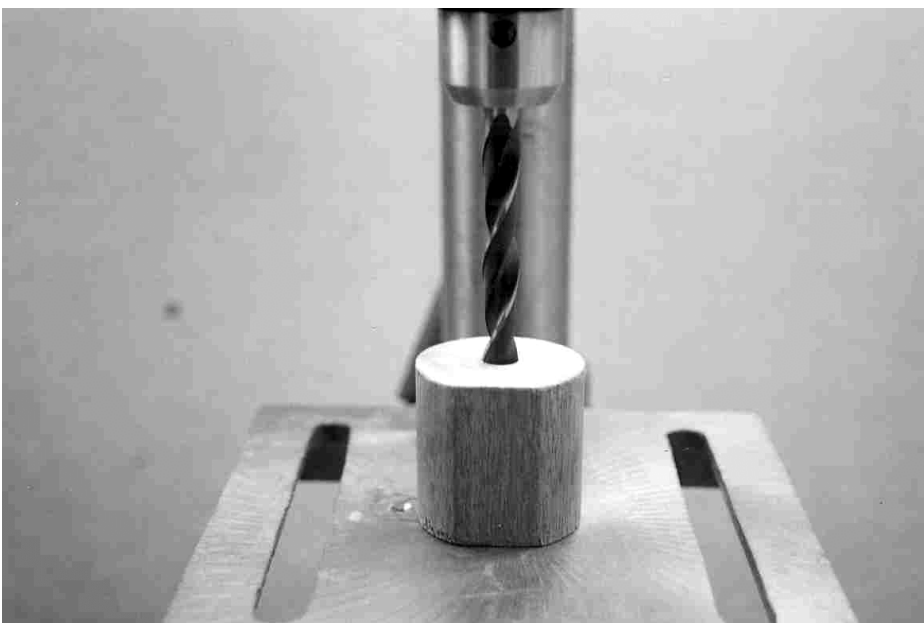

Drilling the bores.

The purpose of the die is to ensure bullets are driven into the cartridge case accurately. The die is made from a simple section of hardwood. I am using a section of banister rail, and a 50mm diameter washer with a

Expedient Homemade Handgun Ammo

10mm diameter hole. We also require an 8mm diameter bolt, 50mm (2") long and two nuts to fit the bolt. Any section of hardwood will do and ideally it should be around 1" in diameter. The rail section I use was actually 45mm in diameter but it was easy to obtain so I used it. Whatever wood section is used, it should measure about 45mm in length.

As shown in the above photo, a hole is drilled through the centre of the die. A drill press must be used for this purpose. We must drill two separate diameter bores through the die, one to accept the case and the other the bullet. *It is of vital importance that both ends of the die are perfectly square before attempting to drill any of the bore holes.*

The first hole to be made is the 'Case Bore' to accept the cartridge case. This is drilled to a diameter of 9.9 or 10mm (25/64"). The second hole to be made is the 'Bullet Bore' to a diameter of 9mm (23/64"). *The bullet bore must be drilled first.*

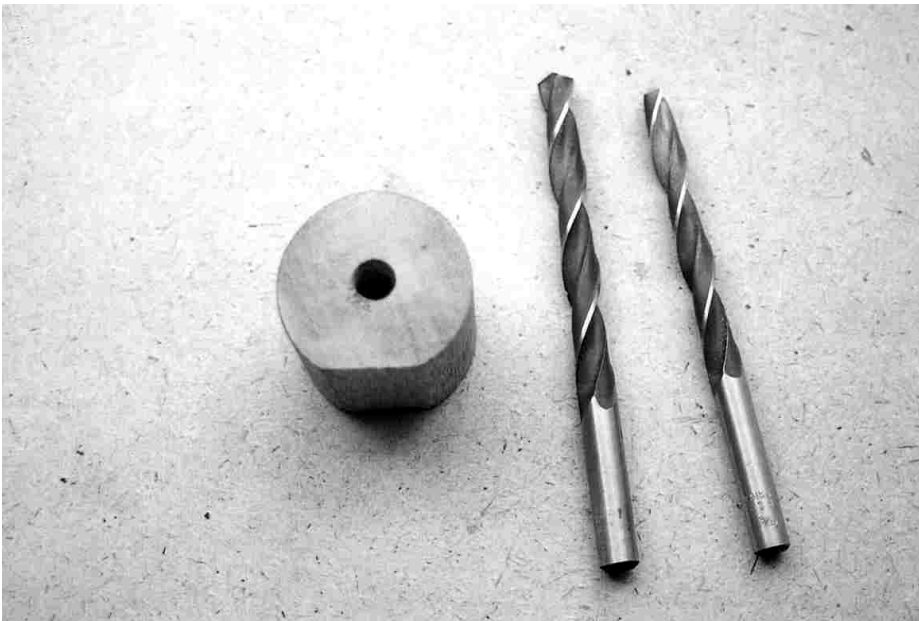

Two bore diameters are drilled.

The two bores must be drilled slowly. At regular intervals during drilling the drill handle should be raised and any wood shavings released from the bit. This will ensure the bores are drilled as cleanly as possible.

To drill the bullet bore hole, hold the die on the drill table and slowly drill all the way through the centre of the die, regularly releasing drill pressure to allow shavings to be removed. *Do not* move or rotate the die once the first hole had been made. Lower the drill table and remove the drill. Now place the 9.9mm 'Case Bore' drill in the chuck and carefully raise the drill table back into alignment with the new drill bit.

Expedient Homemade Handgun Ammo

Now carefully drill the second bore to a depth of 30mm. This is the bore that will accept the cartridge case in due course. The bores of the die should now be inspected to ensure they are clean and true. It is a good idea to insert each of the two drill bits just used back into each bore and rotate them several times by hand to remove any slight imperfections or wood shavings. The top washer can now be screwed to the bullet bore end of the die. A washer of similar diameter to the die should be used, in my case 50mm. Drill a couple of holes either side of the washers 10mm hole and countersink each hole. Now use a couple of short screws to attach the washer to the die. Now attach the two nuts to the bolt and insert the bolt into the die. The die is now ready for use.



The finished seating die.

The two nuts act as an adjustment method to alter as necessary the depth to which a bullet is seated.



LOADING THE CARTRIDGE.



**Insert the die
over the case.**

The .38 cases are now ready to load. The primed case is first placed in the shell holder and the die inserted over the case. The powder charge is then poured into the die's bullet bore. See page 35 for improvised propellant.



Insert the bullet.

The resized bullet is now inserted into the die, as shown above.

Expedient Homemade Handgun Ammo



Insert the bolt.

The seating bolt is now inserted over the bullet. Note that the two nuts are initially screwed onto the bolt a distance of about 3/8" to begin with.



Tap the bolt home.

The seating bolt is now tapped with a hammer, or preferably a hard rubber mallet. The bullet will be driven into the mouth of the case. Adjust the two seating bolt nuts as necessary so as to allow the bullet to be seated until the overall length of the loaded cartridge is 37.5mm. The length of the cartridge should be measured using the vernier gauge.

Expedient Homemade Handgun Ammo

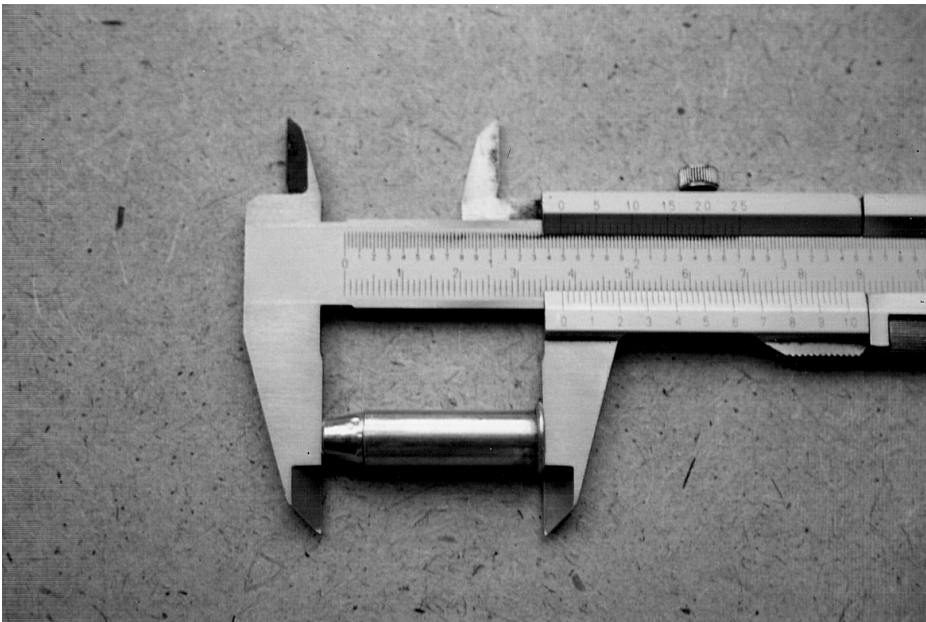

**Checking the
cartridge length.**

Adjust the bolt nuts gradually during the seating of the first bullet until the cartridge measures 37.5mm, as shown above. Once the nuts are 'set' at this position all future cartridges can be loaded without touching the two lock nuts again.



The loaded improvised cartridge compares favourably with its factory made counterpart. Once the necessary materials are acquired and the simple loading tools made, reloading these .38 Special cartridges is nearly as easy as loading using conventional reloading methods.

***Bullet seating die dimensions
for the .38 special.***

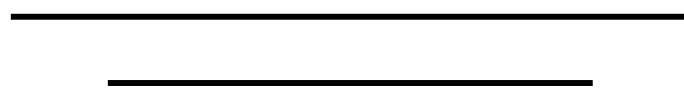
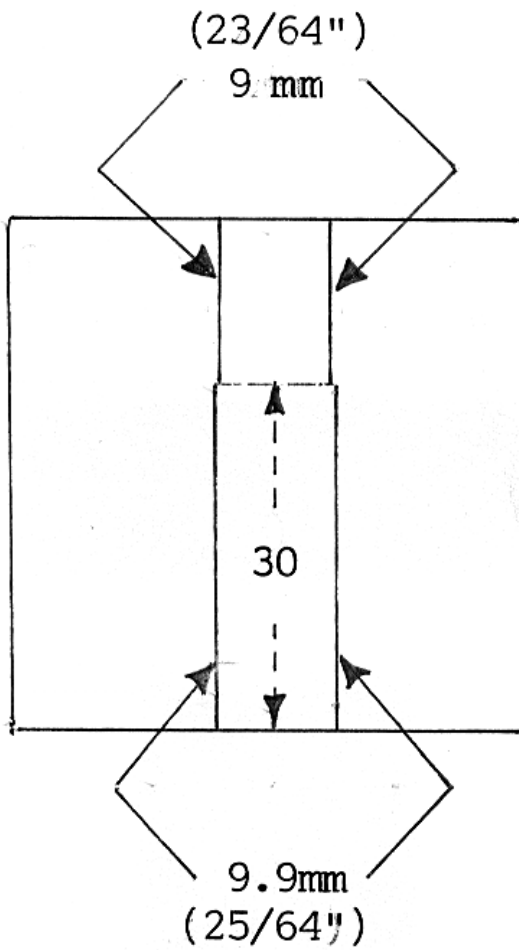

Expedient Homemade Handgun Ammo

As an alternative to using the brass curtain ring for the case rim we can use a simple 10mm diameter circlip, as shown below.



Attach the clip.

The circlip is attached to the case using a pair of circlip pliers. It can be fitted by hand but it is easier with the correct tool. The clip is attached to the very end of the case.

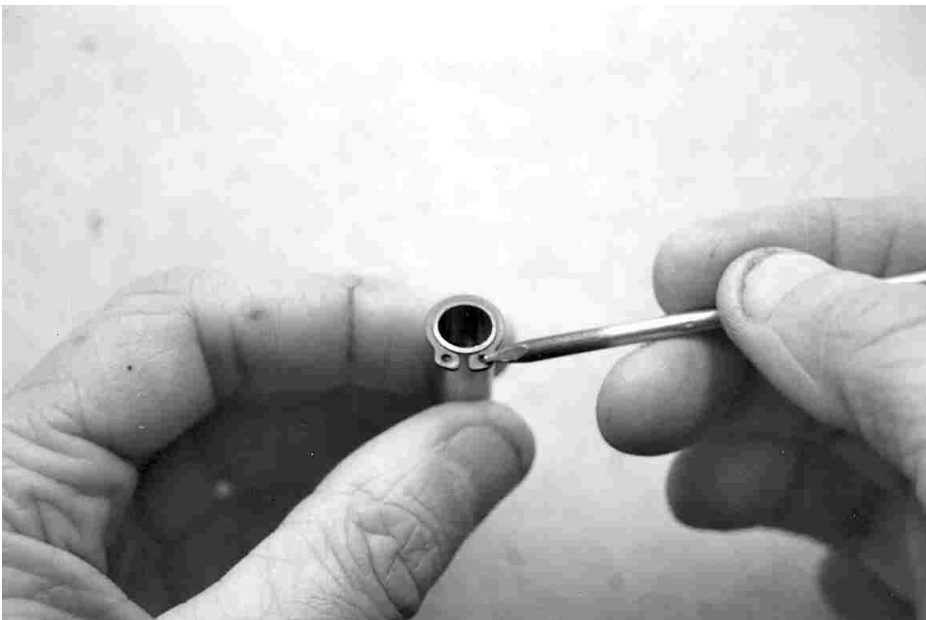

Apply the solder.

Apply solder paint to the clip circumference and solder the clip in place. It is possible to shoot these cartridges in a revolver without actually

Expedient Homemade Handgun Ammo

soldering the clip providing the clip is tight enough but tension of the clips do tend to vary so it will be down to trial and error as to whether you use solder or not. I would strongly advise doing so to make the clip as secure as possible.



Clip attached.

The two clip plier holes will need to be filed or ground away once the rim is fitted to allow the round to be loaded into a revolver cylinder. If the plier holes are not removed the cartridge will still chamber but only with the clips open side facing outwards away from the cylinders axis.

It will be obvious to those readers with a knowledge of revolver and cartridge design history that the circlip is reminiscent of the half moon clips used for loading the .45acp auto pistol cartridges in the revolvers. Our improvised version works just as well !



THE .380 ACP

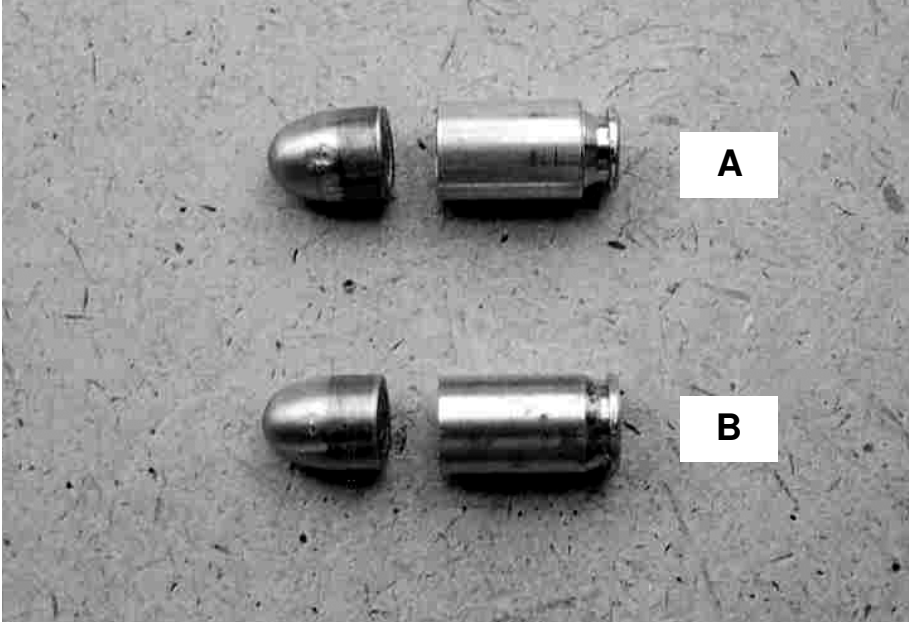

Commercial and improvised .380 cases.

The **.380** automatic pistol cartridge is a very simple cartridge to manufacture. Just like our homemade **.38** cases it is assembled using **3/8"** brass tube and a blank case as the primer.

The photo above shows a commercial **.380** case at '**B**' and a homemade version at '**A**'. To make the **.380** we require two sections of brass tube, one **14mm** length of **3/8"** and a **9mm** length of **11/32"**. Both tubes must be carefully de-burred.

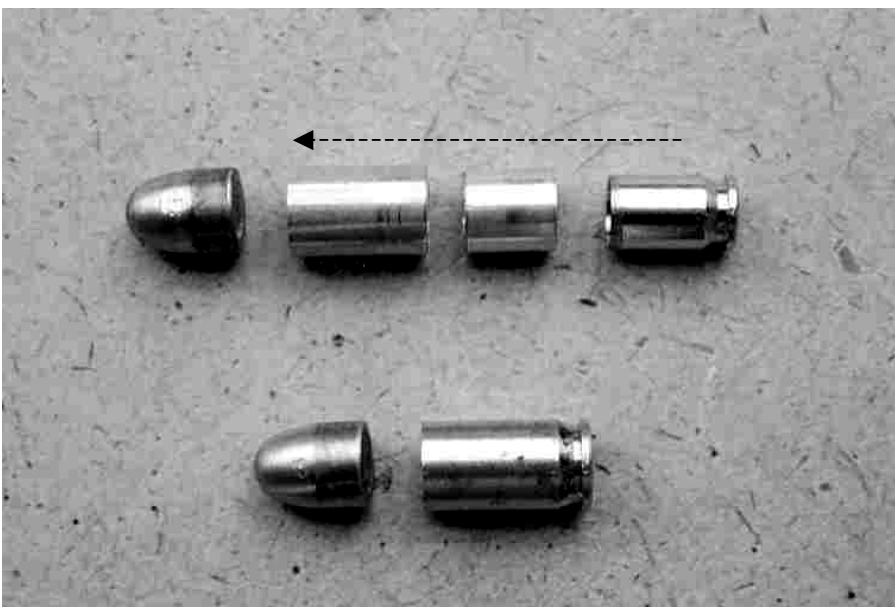

The .380 case components ready for assembly.

Expedient Homemade Handgun Ammo

The above photo shows the three component parts of the improvised .380 case in order of assembly, consisting of two tube sections and an **8mm** modified empty blank case.

To assemble the .380 case apply retainer to the outer surface of the **11/32"** tube and insert it into the **3/8"** tube. Ensure one end of both the tubes are completely flush before the retainer sets.

Allow several minutes for the retainer to set and then apply retainer to the outer surface of the blank and insert this into the flush end of the two tube assembly. Adjust the blank so the case as an overall length of **17mm** and then allow the retainer to set. This is a simple case to make once the necessary tubes are cut to the correct length.

The bullet for the .380 should be sized to **8.9mm** just like the .38 special. The seating die bore depths are as follows:

The 'Case Bore' is drilled to a depth of 16mm.

All other measurements are as for the .38 Special.

The shell holder washers are **1"** diameter with **8mm** and **6mm (1/4")** holes.

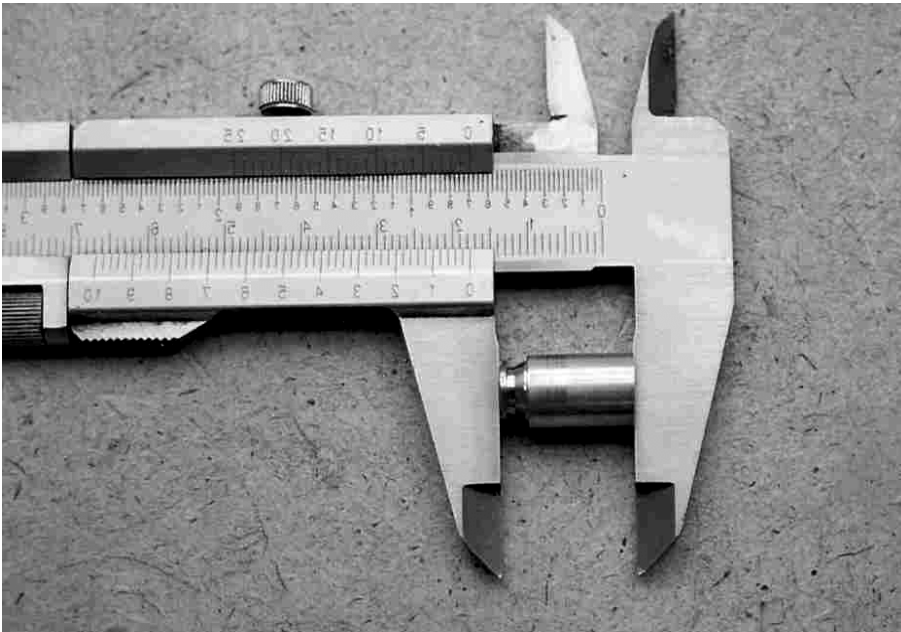

Measure the case.

It cannot be over emphasized how important the de-burring of all tubes used to manufacture these cases is. Each tube must be the specified length and they must slide freely inside each other.

The tubes and blank should be assembled *without* retainer first to ensure they fit together correctly before any retainer is used in final assembly. Once retainer had set hard it will not be possible to make any alterations to the case.

.32 ACP

The **.32** auto pistol round was very popular in its day and there are an enormous number of pistols out there chambered in this calibre.

Making improvised cartridges in this calibre could not be easier as we only require a *single 14mm* length of **11/32"** tube and a modified blank case. There is also no need to re-size any bullets because 'off the shelf' bullets will fit the **11/32"** tube without any re-sizing!

After de-burring the tube, retainer is simply applied to the outer surface of the blank, and the blank inserted into the tube. The case should be measured using the vernier gauge to ensure it is **17mm** in length.



The **.32** case ready for assembly.

The improvised **.32acp** case is shown on right ready for assembly.

A commercial case is shown on the left for comparison.

The seating die '**Case Bore**' diameter should be **9mm**.

The '**Case Bore**' depth should be **15mm**.

The '**Bullet Bore**' diameter should be **8mm**. The same shell holder used for the **.380** case may be used.

When making any of the above cases, it cannot be over emphasized how important the careful de-burring of all the tubes is. Also, all tubes and blank primer should be test fitted first before any retainer is used.

Once retainer sets hard it will not be possible to carry out any adjustments to the cartridge case.

Expedient Homemade Handgun Ammo

If it is found that any small adjustment to the assembled case are necessary once the retainer has set the drill press can once again be used to trim the case length. Obviously, it is the mouth of the case that will be trimmed and not the end containing the primer!

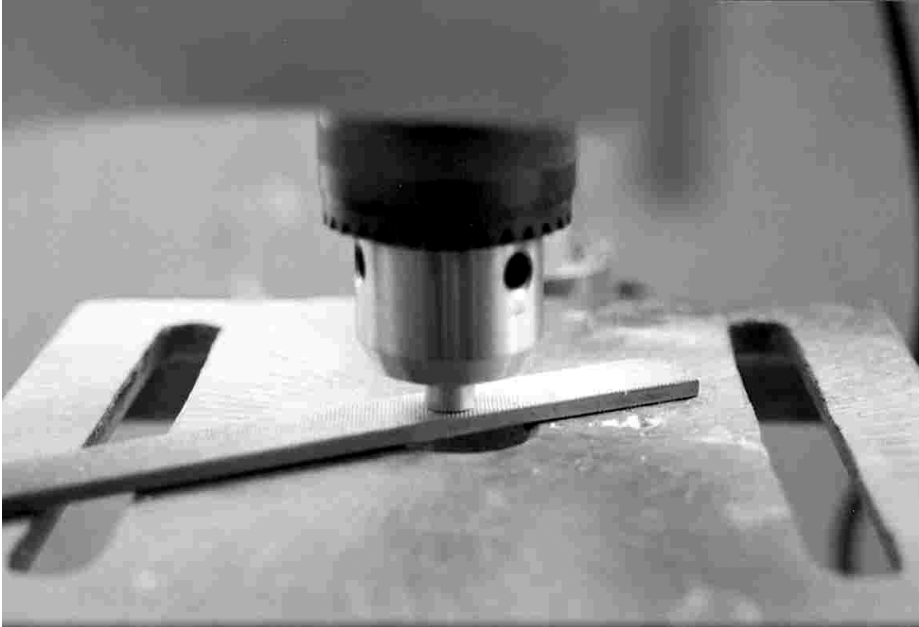

Trimming the case mouth.

The assembled case may be trimmed using the drill press for very small adjustments as shown above.

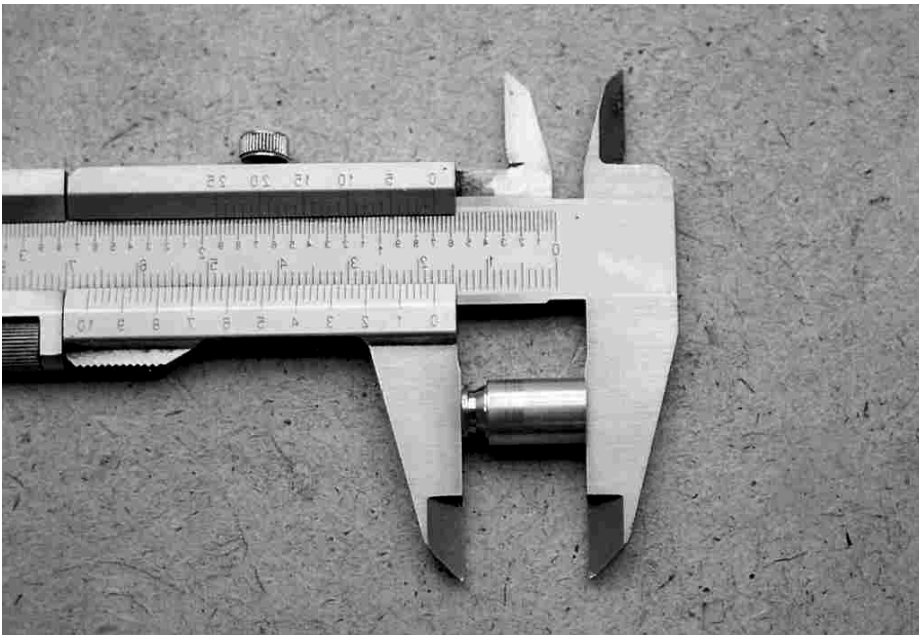

Measure the case.

The length of the finished case must always be checked.

Improvised match head Propellant



The best type of propellant for any cartridge is obviously the kind manufactured for the purpose, but if this is not available we must improvise if we wish to shoot our improvised cartridges.

The simplest of all improvised propellant is the common match head.

I have used both 'safety' and 'standard' match heads to quiet good effect. A reliable method is to 'shave' the match head material from the tips of matches and "powder" (crush) the material on a flat hard surface. For safety reasons only a small number of heads should be crushed at any one time. I usually crush enough match head propellant sufficient for one round at a time, and in the unlikely event of the powder detonating, the result will only be that of a small flame.

The following list shows the correct number of heads for each calibre covered in this book.

.38 Special:	20
.380acp:	10
.32acp:	9

Expedient Homemade Handgun Ammo

An alternative to the match head propellant is black powder. If black powder cannot be purchased it can be sourced from black powder blank cartridges. Because of their large size, the 12 gauge BP blank referred to as 'yachting blanks' or 'alarm blanks' are useful. I have used the black powder obtained through such methods for years in a variety of handguns and rifles shooting both commercial brass cases and handmade versions.



The 12 gauge black powder blank cartridge.

.....Experimentation is the Key To Success

Expedient Homemade Ammo
Copyright P.A.Luty (D.F.C - D.A.C)

No part of this document
may be reproduced with
out the written permission of
the author. All transgressors will be eliminated, or at least made to feel very ill.

The construction of improvised ammunition can be dangerous. This document is a visual commentary of my own ammunition experiments only and does not condone or encourage the manufacture of ammunition by any individual. The information contained in this publication is, therefore, presented for amusement, educational and academic study purposes only.