

R. TALSORIAN  
GAMES, INC.

OAKLEAF

\$ . 00

# BLACKHAND'S STREET WEAPONS 2020

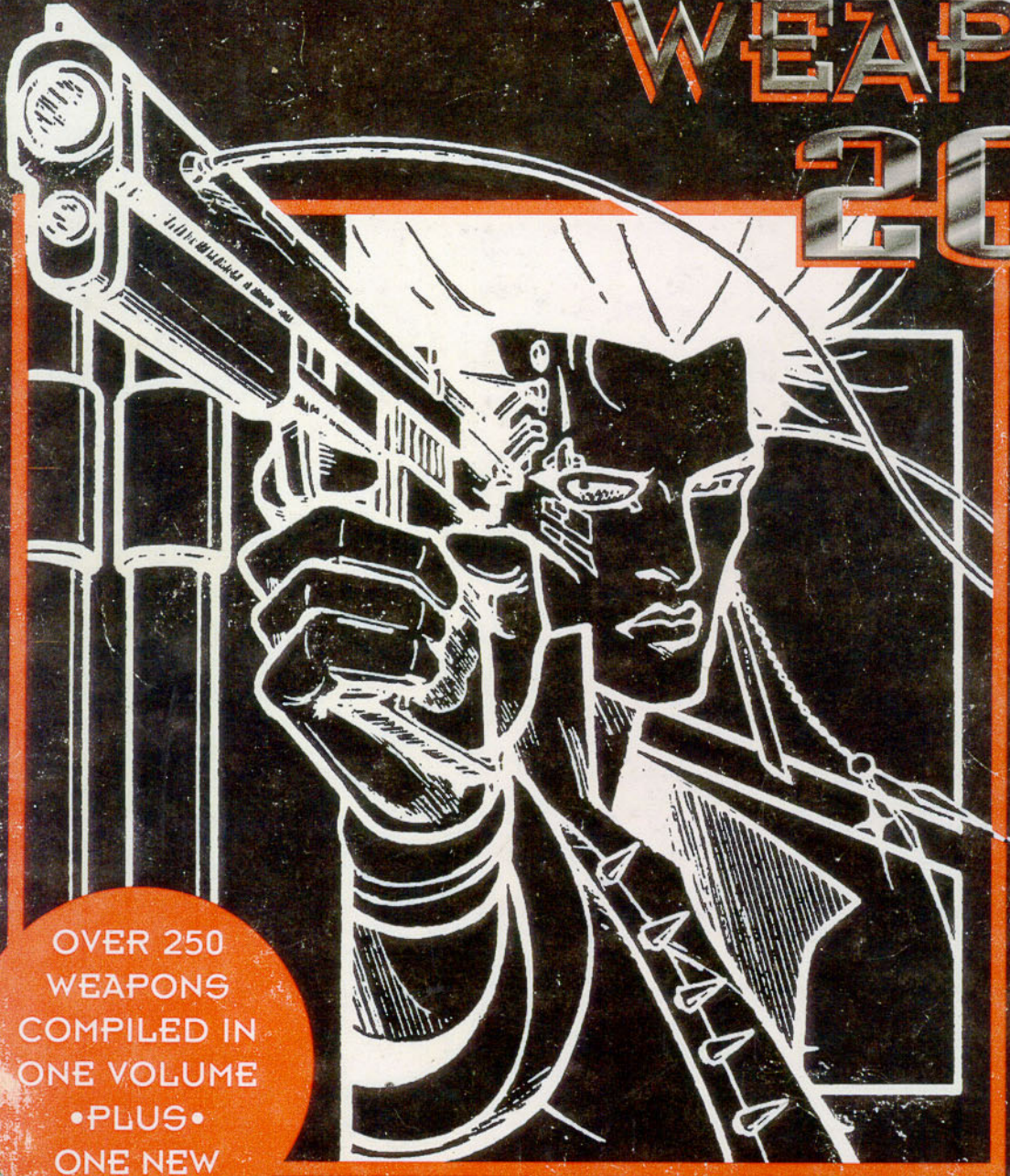

First edition

OVER 250  
WEAPONS  
COMPILED IN  
ONE VOLUME  
• PLUS •  
ONE NEW  
GUN!

Edited by  
Derek  
Quintana

THE CYBERPUNK® WEAPONS COLLECTION

CYBERPUNK®





### **CREDITS**

**WRITERS**  
A cast of thousands

**COVER DESIGN**  
Mark Schumann

**COVER ILLUSTRATION**  
Sam Liu

**LAYOUT**  
Benjamin Wright

**INTERIOR ILLUSTRATIONS**  
Lee Brimmicombe-Wood  
Malcolm Hee  
Chris Hockabout  
Sean Howell  
Karl Martin  
Matteo Resinanti  
Scott Ruggells  
Benjamin Wright

**INTERIOR ILLUSTRATION  
ENHANCEMENT**  
Benjamin Wright

**EDITORS**  
Janice Sellers  
Derek Quintanar, Senior Editor

### **CONTENTS**

Melee Weapons	2
Archery Bows	4
Crossbows	5
Exotic Weapons	5
Light Handguns	10
Medium Handguns	10
Heavy Handguns	14
Very Heavy Handguns	16
Light SMGs	17
Medium SMGs	18
Heavy SMGs	20
Shotguns	21
Assault Rifles	27
Sniper Rifles	29
Other Rifles	30
Machineguns	32
Heavy Weapons	34
'Borg Weapons	37
Hand Grenades	39
Launched Grenades	41
Mines & Explosives	42
Ammunition	43
Special Ammo	46
Recoil & the Heavy Guns	48

## **“YOU ASKED FOR IT— AND NOW YOU’RE GONNA GET IT...”**

**P**LAYERS HAVE BEEN ASKING FOR AN EASY-ACCESS REFERENCE FOR *CYBERPUNK WEAPONS* FOR SOME TIME, ESPECIALLY AS THE NUMBER AND TYPE OF WEAPONS GREW AND DIVERSIFIED. GATHERED IN THESE PAGES ARE OVER 250 ITEMS FOR HARMING YOUR FELLOW ‘PUNK—AND ANY BYSTANDING CIVILIANS, HAPLESS POLICE, BOOTLICKING CORP TOADIES, ETC. THAT HAPPEN TO BE WITHIN RANGE...

THE ENTRIES ARE ORGANIZED BY WEAPON TYPE AND ALPHABETIZED WITHIN EACH CHAPTER. AS A BONUS, WE THREW IN THE VARIOUS AMMUNITION RULES THAT HAVE APPEARED OVER THE YEARS, PLUS THE RECOIL RULES FOR THE BIG ‘BORG GUNS. SOME WEAPON STATS MAY SEEM SLIGHTLY DIFFERENT FROM HOW YOU REMEMBER THEM; THAT’S BECAUSE WE’VE FINALLY HAD THE CHANCE TO APPLY ALL THE ERRATA AND GAME-BALANCE CORRECTS THAT HAVE ACCUMULATED OVER THE YEARS. CONSIDER THIS TO BE THE *DEFINITIVE* PRESENTATION OF THE *CYBERPUNK 2020* PERSONAL-LEVEL WEAPONRY.

THIS IS THE LAST WEAPON-ORIENTED PRODUCT WE’LL BE DOING FOR SOME TIME, SO AS A GOING-AWAY PRESENT, RTG HAS THROWN IN A *BRAND NEW GUN* CREATED ESPECIALLY FOR THIS BOOK! NOW, HOW MUCH WOULD YOU PAY...?

YOU’VE GOT THE DARKEST PART OF THE DARK FUTURE IN YOUR HANDS—NOW TAKE IT TO THE BAD GUYS AND GET THEM BEFORE THEY GET YOU!

**DEREK QUINTANAR, S.E.**

R.TALSORIAN  
GAMES, INC.

ISBN #: 0-937279-75-7  
PRODUCT: CP3461

PUBLISHED BY R. TALSORIAN GAMES, INC.  
P.O. BOX 7356, BERKELEY, CA 94707, USA

Copyright 1995, by R. Talsorian Games, Inc. Cyberpunk® is a trademark of R. Talsorian Games, Inc., All Rights Reserved under the Universal Copyright Conventions. All situations, governments and people herein are fictional. Any similarities portrayed herein without satiric intent are strictly coincidental.



# MELEE WEAPONS

**Basic Melee Weapons**

These are the standard muscle-powered devices that have been in use since medieval days. All basic melee weapons gain the melee damage bonus based on Body Type. All edged melee weapons (knife, sword, axe, etc.) gain AP ability vs. soft armor. [Cyberpunk 2020]

<u>CLUB: FREE</u>	MEL 0 L C 1D6 NA NA NA NA	<u>SHURIKEN: 2-3EB</u>	MEL 0 N C 1D6/3(+POISON) NA NA NA THROW
<u>KNIFE: 1-20EB</u>	MEL 0 P C 1D6 NA NA NA THROW	<u>SWITCHBLADE: 15EB</u>	MEL 0 P C 1D6/2 NA NA NA NA
<u>SWORD: 20-200EB</u>	MEL 0 L C 2D6+2 NA NA NA NA	<u>BRASS KNUCKLES: 10EB</u>	MEL 0 P C 1D6+2 NA NA NA NA
<u>AXE: 20EB</u>	MEL -1 N C 2D6+3 NA NA NA NA	<u>SLEDGEHAMMER: 20EB</u>	MEL -2 N C 4D6 NA NA NA NA
<u>NUNCHAKU/TONFA: 15EB</u>	MEL 0 L C 3D6/2D6 NA NA NA NA	<u>CHAINSAW: 80EB</u>	MEL -3 N C 4D6* NA NA NA 2M
<u>NAGINATA: 100EB</u>	MEL 0 N P 3D6 NA NA NA 2M	(*Acts as AP vs. soft armors, damages them 2SP/hit)	

**Bayonet/Survival Knife: 50eb**

MEL 0 J C 1D6AP NA NA NA NA

Analogous to the KCB-70, M9 Bayonet, or other survival knives, this weapon has many features including a sharpening stone (in the scabbard), screwdriver, wire cutter, compass (on the pommel), bottle opener, and saw blade. The pommel can be unscrewed to open the hollow handle, which is waterproof to 12 meters. Inside is a 3m fishing line with 2 hooks, 10 strike-all water-resistant matches, and a small packet of blade oil. The weapon can also be attached to any rifle or SMG with a standard bayonet lug. [NeoTribes]

**Entrenching Tool: 50eb**

MEL 0 L C 2D6 NA NA NA NA

The entrenching tool is one of the stand-by pieces of equipment that armies of the world have carried (in one form or another) since civilization began. The modern version is a combination shovel, axe and saw. It is made of metal alloys, and collapses into a package the size of a large book. With this tool a nomad can dig a latrine, chop down a tree, or saw through an obstacle. Entrenching tools can also be used as fairly vicious weapons if nothing else is available. Note: Because of its pick-like nature, the e-tool gets AP ability vs. hard armors as well. [NeoTribes]

**Excalibur Nightstick: 80eb**

<u>TASER-TYPE</u>	MEL 0 J P	STUN (TASER)	8	1	ST	NA
<u>MACE-TYPE</u>	MEL 0 J P	GAS EFFECT	6	1	ST	NA
<u>BASIC-TYPE</u>	MEL 0 J P	2D6+3	NA	NA	R	NA

The melee weapon for the police officer of the 21st century, this state-of-the-art nightstick is manufactured from industrial strength ceramics. In addition to its solid hitting power, the ENS is equipped with two hidden extras, ideal for suprising the creeps on the street. The business end of the weapon incorporates a taser or hidden mace-sprayer, while the side handle holds the trigger mechanism. Just right for those punks who won't lie down! The taser is rechargeable from any standard wall socket, while new mace canisters can be bought for 5eb a six-pack. [Protect & Serve]

**IMI "Chainknife": 120eb**

MEL 0 J P 2D6+1 NA NA VR NA

Designed and manufactured in Israel, the ChainKnife has seen a great deal of use with Mossad agents. Shaped somewhat like a survival knife, this is a battery-powered (2 hours) hand-held combat saw which can chew through armor like cheesecloth (SP x1/2, soft armors are reduced 2 SP/hit)! [Chromebook 2]



**Kendachi M-33 Powersword: 860eb**

MEL 0 L R 4D6 NA NA T NA

Combining elements of the popular Kendachi mono-line with a powered handle, the Powersword vibrates its molecular crystal blade 2000 times per minute. Combined with a microscopically serrated edge, this weapon literally chews its way through anything it encounters, including armor (soft armor SP x1/4, hard armor SP x1/2), metal, flesh and bone. The blade activates when the handle is gripped, but takes 1 combat turn to warm up. Although the current model is quite heavy (3kg) and fragile (breaks on a fumble, shatters on a parry check of 5 or less on 1D10), Kendachi is currently testing a new model for release in 2022. [Chromebook 1]

**Kendachi Mono-Two: 650/700eb**

MEL +1 J/N P/R 2D6/4D6 NA NA VR NA

An improved version of the original Kendachi monoblade, favored by corporate samurai everywhere. A thicker blade cross section reinforced with Orbital crystal strengthens the weapon against parries (shatters on a 2 or less on 1D10) and bad cuts (no breaking on a fumble). For an additional 50eb, you can have a miniscule laser implanted in the hilt; while it has no effect on combat, the laser refracts with the crystalline blade, giving it the flaring neon glow of a movie "light saber." Blade tints include red, blue, white, green, violet, orange and rainbow. Sold only in traditional two blade sets. [Chromebook 1]

**Kendachi MonoKatana®: 600eb**

MEL +1 N R 4D6 NA NA VR NA

Sword length version of monoblade. Resembles a high-tech katana with a milky, nearly transparent blade. Also available in a naginata form for 100ebextra. [Cyberpunk 2020]

**Kendachi Monoknife®: 200eb**

MEL +1 P P 2D6 NA NA VR NA

An incredibly sharp, mono-sectional crystal blade. Produced in the Japanese "tanto" style. Note: Unless stated otherwise, soft armors are x1/3 SP and hard armors are x2/3 SP vs. all monoweapons. [Cyberpunk 2020]

**Kendachi Monosword Cane: 255eb**

MEL +1 L P 3D6 NA NA VR NA

The element of surprise is yours with the monoblade hidden within this rich, synthetic mahogany-finished walking cane. Twist the handle to the left, and a lock will release the 55cm blade. Note: This weapon will shatter with a 4- on 1D10 if fumbled or parrying. Otherwise it is consistent with all other rules governing monoweapons (see CP2020). [Solo of Fortune 2]

**Kendachi Monowhip: 350eb**

MEL 0 J P 2D6 NA NA ST 1-3M

Following in the tradition of the popular cyberweapon, Kendachi's Monowhip houses a spool of monofilament wire in an ergonomically designed handle. The wire has a small weight at one end for balance and swing, and can be extended up to 4m in length or reeled in at the push of a switch. The Monowhip can therefore be used as a garrote, cutter, or razor-sharp grapple. The monomolecular wire will cut through almost any organic material as well as most plastics, doing 2D6 damage (double damage on a critical success). [Chromebook 2]

**Mystic Technologies Spring Knife: 125eb**

MEL 0 P C 1D6 NA NA ST NA/5M

On first inspection this knife appears to be the standard survival variety, but in fact its blade can be released and launched via a high-powered spring. The blade has a range of 5m and inflicts 1D6 points of damage. The knife takes 2 rounds to reload. [Chromebook 2]

**Mystic Technologies Nunchaku/Blade: 200eb**

CONCEALMENT/ACCURACY/DAMAGE AS PER NUNCHAKU & SWORD.

Mystic Tech continues to amaze with its innovative melee weapon systems. This weapon is 60cm long staff with an extendible blade at one end. The blade is 30cm long and inflicts 1D6+1 points of damage (2D6+1 if used 2-handed). When a release button is pressed the staff splits and forms a pair of nunchaku. Note: You cannot use the nunchaku function if the blade is extended! [Solo of Fortune 2]

**Nomad Smartwhip: 600eb**

MEL 0 J C 1D6+2+STR NA NA ST 1-3M

The smartwhip was first seen in combat at a demonstration held by members of the Blood Tribes in 2015. This is a device that uses myomer technology and neural interface to create a very dangerous weapon derived from a bullwhip. Parts of the weapon can be made to flex or be rigid on command (and if the tip becomes rigid while traveling 100 kph, it really hurts when it hits you). Note: You must have interface plugs and Machine Link to use this weapon. [NeoTribes]







**SPM-1 Battleglove: 900eb**

MEL -2 N P 3D6/2D6 NA NA VR NA

This is a large gauntlet covering the hand and forearm. It does 3D6 in crush damage, 2D6 punch damage, and has three spaces which can be used to store any standard cyberarm option. [Cyberpunk 2020]

**SlamDance, Inc. Spawnblade: 450eb**

MEL 0/+1 J P 1D6+BOD/1D6+4 NA NA ST THROWN

With the Spawnblade, SlamDance, Inc. puts the "combat" look back into the combat knife! To the naked eye, the Spawnblade just looks much like any combat knife that has been balanced for throwing (1D6+BOD modifier damage). The differences manifest only in combat: Once the safety is disabled, the Spawnblade's memory-metal blade has the ability to "fan out" its cutting edges. On any combat hit that does more than 4 points of damage (including BOD bonuses to damage, but before BTM) and gets past your opponent's armor, the Spawnblade can be triggered. The blade spreads into a razor-sharp 50° spatula—inside your opponent's body! This does an additional 1D6+3 (armor won't help). Once opened, the Spawnblade can only be safely removed with a Medtech roll of 20; any other means of removal will cause the victim another 1D6/2 damage. The Spawnblade comes with a safety sheath in a choice of designer colors. [Chromebook 2]

**Utility Sword/Machete: 60eb**

MEL 0 L C 1D6+3 NA NA NA NA

These are used by almost all the nomad tribes as an agricultural tool, utility knife, and last-ditch defensive weapon. The utility sword can differ in style and appearance from a "trench-knife" style to a "machete" style. Many of the tribes have adopted specific styles or knives, like the Aldecaldo's machete, as a badge of tribal alliance. [NeoTribes]

# ARCHERY BOWS

**These are bows that are drawn, held, and fired with a straight pull, rather than being crossbows. There are quite a few bows from different companies available; the bows below are simply representative of the different types. Unless noted, all damage is treated as a Knife for AP purposes (assuming the use of broadhead arrows).**

**Arasaka Arms Half-Bow: 100eb**

EX -1 L P 3D6 12 1 VR 100M

A recurve short bow that can be taken apart into two halves. Made out of scanner-resistant composites. [Solo of Fortune 2]

**Eagletech "Bearcat" Self Bow: 500eb**

EX +1 N P 6D6 12 1 VR 150M

A recurve made out of maximum-strength composites, with all the power of a normal 60-kilo bow. It can be taken apart into two halves. Please note that the pull of this bow remains at 60 kilos at all times, not stepped down by pulleys! Characters holding this bow will have to start making Strength Feat skill rolls after one combat round of holding it. [Solo of Fortune 2]

**Eagletech "Tigercat" Compound Bow: 500eb**

EX +1 N P 6D6 12 1 VR 150M

A professional's compound bow, pulling 60 kilos (stepped down to 30). Comes complete with computerized sight and gyro-stabilization. [Solo of Fortune 2]

**Eagletech "Tomcat" Compound Bow: 150eb**

EX 0 N C 4D6 12 1 VR 150M

A more expensive, gyro-stabilized compound bow with a 40-kilo pull (stepped down to 20 kilos). Silent and deadly. [Cyberpunk 2020, Solo of Fortune 2]

**Eagletech "Wildcat" Sport Bow: 35eb**

EX 0 N E 3D6 12 1 VR 100M

A simple 20-kilo pull recurve bow, cheap and popular. [Solo of Fortune 2]







# CROSSBOWS

**Crossbows are either cocked by the user (that is, the user uses his own strength to pull back the string) or cocked mechanically, utilizing a winch or other device to drag the string back into position. Unless noted, all damage is treated as a Knife for AP purposes (assuming the use of broadhead arrows).**

**Eagletech "Arbelest" Crossbow: 500eb**

EX 0 N P 5D6 12 1/2 VR 150M

A 60-kilo pull bow, cocked by using a built-in winch. Characters with a cyberarm and internal bracing (muscle and bone lace, body-plating breastplate, FMJ) can reload manually, raising the ROF to 1. This bow is quite large, with 50% more bulk than an assault rifle. [Solo of Fortune 2]

**Eagletech "Handbow" Crossbow: 75eb**

EX -1 J E 1D6+2 12 1 VR 25M

This is a hand-held crossbow with a 7-kilo pull. It can be installed in a cyberarm with autoloader for 300eb (the installation uses all the option spaces in the arm). [Solo of Fortune 2]

**Eagletech "Scorpion" Crossbow: 1500eb**

EX 0 N P 7D6 6 1/2 VR 200M

A 120-kilo pull bow, cocked by a power winch. This winch can be removed, if desired, but then the bow can only be cocked by full 'borg conversions and people with two cyberarms (or a cyberarm and a cyberleg) and spinal bracing (MBL, breastplate, FMJ). Manual cocking with two cyberarms or by a full 'borg raises the ROF to 1. This bow is huge, easily the size of a Barret-Arasaka 20mm! Anyone hit with a quarrel from this bow has to succeed at an Acrobatics roll of 20+ to remain standing after the impact, otherwise he is knocked over. [Solo of Fortune 2]

**Eagletech "Stryker" Crossbow: 220eb**

EX -1 N C 3D6+3 12 1 VR 50M

A 20-kilo pull plastic and bimetal sport crossbow, cocked and fired by the user. [Cyberpunk 2020, Solo of Fortune 2]

**Nomad Hand Crossbow: 100eb**

EX 0 N R 1D6+1AP 1 1 ST 20M

This weapon is sometimes used by nomads to flatten tires and distract drivers. The weapon is AP, but damage is not halved. The weapon is usually hand-made and found in pistol form, but the basic frame can be strapped to the forearm, and fired by a string trigger tied to a finger. [NeoTribes]

# EXOTIC WEAPONS

**APEX Mobile Point Defense System: 10,000eb.**

HVY X N P 2D6+4 (9MM LC) 400 40 ST 200M

Based on the Phalanx automated weapons systems of the U.S. Navy, the APEX Point Defense System is a movable light machinegun, capable of defending a secure area by itself, or under the direction of a remote operator. Most Corporate aerodyne pads and rooftops are defended by larger and more expensive versions of the APEX; however, this little beauty puts maximum point defense control in the hands of even the smallest business or homeowner. And it only weighs 20kg, allowing it to be carried to new locations easily! The upper part of the APEX dome houses four computer-controlled motion sensors with an effective range of 200 meters. When a target moves across the sensor's 360° field of fire, the central mini-gun tracks the target, adjusts for movement, and fires. Sensors can be set for a specific target size, from that of a small rodent up to a large vehicle. A hand-held controller allows the operator to activate the APEX from as far away as 1000 meters; the controller can also be used to activate individual APEX units by location (each one is assigned a number and frequency), or to deactivate specific units, allowing the operator to enter at will. The APEX unit is self powered, with a battery life of





50 hours (this may be extended by linking a solar panel to the unit). The internal drum magazine holds 400 rounds of 9mm Long Caseless ammunition (the same as used in the innovative Militech High Power-15 SAW). An automatic shut-off will disable the weapon in the event of a jam, signalling the operator through the remote control. The APEX has an SDP of 20, and an SP rating of 5. To determine hits, roll percentage for each target in range, then roll 1D10 for number of hits on each. Add 10% to hit percentage if target is moving at half speed or less. [*Chromebook 1*]

Range	+150	75	35	15
% To Hit	10	20	30	40

### Arasaka "Nauseator" Riot-Control Device: 1900eb

EX 0 N P SPECIAL 10 1 ST 15M

The latest in large-scale crowd control: a field generator (0.6m wide x 1.7m tall) producing ultrasound waves in a conical pattern 15m deep and 25m wide. All targets within the pattern must make a 25+ BOD check to avoid disorientation, headaches and nausea. Target must be in area of effect for a minimum of 2 combat rounds before making BOD check. The following cyberaudio options make the BOD check 1 level more difficult: Amplified, Increased Hearing Range. Special headsets or earplugs reduce the BOD check difficulty by 1 level. The following cyberaudio options make you immune to the effects: Sound Editing, Level Damper. [*Chromebook 2*]

If successful: Debilitation (-4 to all actions for 1D6 rounds)

If failed by 1-3 points: Incapacitation (REF and MA reduced to 1 for 1D6 rounds)

If failed by 4+ points: Serious Incapacitation (unconscious for 1D6 minutes)

### Arasaka Restraint Caster: 200eb

P -1 J P TANGLE (15MM) 4 1 ST 25M

Advances made by Arasaka in reactive polymers have made a popular weapon from generations of science-fiction stories a reality. This oversized pistol fires a low velocity capsule of reactive polymer which, upon contact with the atmosphere, assumes a semi-solid form and spreads into incredibly strong tendrils of polymer. These strands wrap around anything that they come into contact with. A human entangled by these strands will be effectively immobilized. The tangles may be broken through, requiring a Very Difficult roll against Body Type (or against the strength of a linear frame or other cybernetics). The polymer dissolves in around 20 minutes (plus or minus 1d10 minutes) or can be removed with a solvent. Polymer shells cost 60eb for a case of 20, and a solvent spray costs an additional 10eb (10 uses). [*Protect & Serve*]

### Arasaka WXA Computer-Aimed Weapon: 3000eb

HVY 0 N R 6D6+2 (7.62MM) 500 20 VR 400M

One of the security manufacturing department's "lethal deterrent systems," the WXA is a belt-fed, computer aimed and fired machinegun. It can be programmed to key on motion or heat, and to fire in any arc from 10° to 360° and any range from 400m to 2m. It operates in all light conditions. The WXA requires an external power source, but its computer is integral. WXAs can be remotely monitored, aimed and triggered. The gun's to-hit roll is 10 + 1D10. It is subject to all to-hit modifiers. WXAs can be programmed to recognize friendlies if the friendlies are wearing small IFF radio pulsers. The pulser is about the size of a pen, and broadcasts a code which can be set by the gun's owner. This prevents unauthorized pulsers from disarming the guns. The WXA weighs 50 kilos, is the size of a squad automatic weapon mounted on a small crate, and can be free-standing or mounted in a structure. A recoil buffering system keeps the guns from shifting much when fired free-standing, but the manual recommends bolting them down as a safety measure. The guns are not designed to detach from the base, or to be hand operated. Price covers gun, remote monitor and 500 rounds of disintegrating belt ammo (cased or caseless). [*Corpbook 1*]

### Avante P-1135 Needlegun: 200eb

P 0 P P DRUGS(NEEDLE) 15 2 ST 40M

Lightweight, plastic, compressed-air powered. Can be doped with drugs, poison. See *CP2020* for details. [*Cyberpunk 2020*]

### Dynatech Industries Hand Taser: 50eb

EX 0 P E STUN 12 1 VR 1M

The most common taser weapon in space; the hand taser must be touched to bare skin in order to deliver its charge. Targets must make a Stun Save at -2, or be stunned unconscious for 1D10 minutes. If the save is made, REF & COOL are still halved for 1D10 minutes. [*Deep Space*]

### Enertex AKM Power Squirt: 15eb

P -2 J C DRUGS 50 1 VR 10M

A squirtgun. Yes, a powered squirtgun. See *CP2020* before you laugh. [*Cyberpunk 2020*]

### Kendachi Dragon: 660eb

EX 0 J P VARIES 4 1 ST 4M

This hand-held flamer provides destruction at your fingertips. The ignition must be activated 1 combat round. before firing. Creates a 4m flame, doing 2D6 spread over 2 random body areas first round, 1D6 to 1 area second round. Only hard armor, or soft armors of SP 15+, will protect the target. All soft armors will be damaged 2 SP instead of 1. [*Chromebook 1*]







**Kendachi Monowire: 60eb/Meter**

String it at neck level, and watch your pursuit go to pieces; string it at ankle level, and watch intruders lose their footing! Available in varying lengths, Kendachi's monomolecular wires are capped with synthetic bulbs at either end for safe handling. The ultimate trap element, and ideal for slicing your cheese, too. Note: Monowire does 3D6 cutting damage; armor is x1/3. [Chromebook 2]

**Malorian Arms Sliver Gun: 375eb.**

P 0 J P VARIES (SLIVERS) 7 2 UR 40M

Quiet and deadly describes Eran Malour's revolutionary new personal defense weapon. Recent discoveries in flywheel technology have been utilized in creating a close range weapon that is as effective as a shotgun but no louder than an electric toothbrush. The sliver gun uses a squeeze cocking action to activate the four-inch flywheel. When triggered, the wheel presses against a polyceramic block creating a multitude of sharp, 4cm fragments traveling well in excess of 1200 feet per second! The internal power cell can spin the flywheel up to eighteen minutes before replacement (cost per cell: 7eb). The sliver gun is also available in an accessory cyberarm version (Price 550eb, HC=1D6+2). Notes: The weapon produces 2D6 fragments/hit, each doing 1D6/2 damage; treat as a Knife for armor penetration. [Chromebook 1]

**Militech Electronics LaserCannon: 8000eb**

RIF 0 N R 1-5D6 10 2 UR 200M

Milspec laser cannon, rarely seen. The damage can be metered in D6 increments. See CP2020 for details. [Cyberpunk 2020]

**Militech Electronics Taser: 60eb**

P -1 J C STUN 10 1 ST 10M

Zap. About the size of a small hand flashlight, firing a set of wired darts. What's more, a quick jolt to a metal cyberarm could short the whole thing out (20% chance unless shielded) and make it useless. See CP2020 for details. [Cyberpunk 2020]

**Militech Electronics Taser II™: 100eb**

EX 0 P C STUN 4 2 VR 1M

The newest in personal protection for the non-violent person. This little friend is capable of delivering a 15,000 volt charge to a touched target. Reach out and say hello to that perp with the modern answer to crime. The new Taser II™, brought to you by the people at Militech—because we care about your safety. Note: Target must make a Stun Save with an additional -1 to avoid its effects. See taser rules in CP2020 for more details. [Chromebook 2]

**Mitsubishi Taser: 100eb**

P 0 J P STUN 12 1 ST 5M

A standard defensive weapon for JAB security men in the construction shacks, this taser fires wire-trailing darts up to 5m away. The darts will penetrate up to 5SP of soft armor. If hit, the victim must make a Stun Save at -1 or be stunned for 2D6 minutes. Should the save be made, REF & COOL are still halved for 1D6+1 minutes. [Deep Space]

**Mystic Technologies Arrow Gun: 1000eb**

RIF +1 J(L) C 3D6 1 1 ST 70M

Includes a waterproof case (SP10) with slots for eight 35cm aluminum arrows with carboglass broadhead blades (treat as Knife for AP damage). It also comes with a preconfigured mount that can accommodate most scopes and laser sights. With the collapsible stock extended, concealment is lowered to L. Arrows are 5eb each. [Solo of Fortune 2]

**Nelspot "Wombat" Airpistol: 200eb**

P -1 J C DRUGS 20 2 UR 40M

Paintball gun from hell. Can fire acid, paint, drugs, poison. See CP2020 for further rules. [Cyberpunk 2020]

**Nomad Boomerang: 20eb**

EX -1 L P 2D6 1 1 VR 30M

This is not the "look, it comes back" version of the boomerang; it is a heavier killing design that will not return. One arm of the weapon is cut short and sharpened to split open the target (preferably a head). Note: This weapon gains the BOD Type melee bonus when thrown. [NeoTribes]

**Nomad Pneumatic Bolt Gun: 350eb**

EX -1 N R 3D6AP (BOLT) 4 1 ST 25M

This is an air weapon based on pre-collapse paintball weapons. It has four rotating barrels and fires a much larger bolt than a cross-bow. It is also used for harassing drivers and shooting tires. The weapon is AP, but damage is not halved. Damage drops to 2D6 over 25m, and the weapon is ineffective over 50m. Air is supplied by a cylinder that doubles as a stock. There is enough propellant to fire eight bolts. New cylinders cost 30eb, but no recharge cost, providing the user has access to an air compressor. [NeoTribes]



**Nomad Slings: 10eb**

EX O P P 1/2D6 1 1 VR 20M

One of the oldest weapons in mankind's arsenal, this weapon is still popular with children and people who wish to remain silent. The ammunition is usually a small stone; it makes for easy reloading. Note: This weapon gains the BOD Type melee bonus when used. [*NeoTribes*]

**Petrochem Drug-A-Thug™: 150eb**

EX O P C CHEMICAL 5 1 VR NA

The latest thing to hit the streets of 2020, this handy-dandy little device delivers a solid dose of any paralyzing or sleep-inducing drug that the wielder chooses. Compact, it is capable of fitting into most pockets and purses. Only slightly larger than a touch taser, the Drug-a-Thug™ is perfect for those who wish to be discretely armed. Any target struck must make a Very Difficult BOD check (plus *Resist Drugs* skill) to avoid its effects. Reloads cost from 10-20 eb per dose. Capable of being loaded with any drug. The device will not penetrate armor. [*Chromebook 2*]

**Pursuit Security, Incorporated Beanbag Gun: 100eb**

P -2 J E STUN 1 1 ST 3M

This compact weapon, shaped like a bicycle pump, delivers a small, soft beanbag up to 3m away at 300fps. Compressed air cartridges (good for up to 5 shots) are extra. Any area hit that is not armored will be numbed unless a Very Difficult BOD check is made (Endurance skill applies). The ammo is blister-packed and can be found on the wire spin-racks at discount stores. [*Solo of Fortune 2*]

**Pursuit Security, Incorporated Stundart Pistol: 109eb**

P -1 J C STUN (.45 LVD) 2 2 VR 50M

For the Solo needing a non-lethal alternative, the stundart gun is an excellent choice. This weapon is an over-and-under double-barrel break-open configuration. The stundart ammunition itself consists of a special low velocity (400 fps) .45 caliber plastic cartridge. The projectile is a pronged copper-jacketed capacitor capable of storing a charge of up to 70,000 volts (-1 to Stun Save)! The dart-like projections allow the round to deliver its charge through heavy clothing, fur, and even some ballistic cloth armors (penetration of soft armor up to 5SP is possible). Incapacitation is instantaneous and lasts up to one hour. **Note:** This weapon is unsafe to fire with any regular ammunition (90% chance of misfire, 2D6+1 damage to shooter's arm). Projectiles are sold four to a package and have an expiration date for use. [*Chromebook 1*]

**Pursuit Security, Incorporated Webgun: 250eb**

RIF +1 N C ENTANGLE 1 1 ST 30M

P.S.I. introduces its "long-range mantrap." A spiderweb-like nylon net is deployed by four weights fired in a conical pattern. Notes: A man-sized target must make 25+ BOD and REF checks; failure of both checks means entanglement—1/2 REF, 0 MA. A single failure means target will escape in 10-(BOD or REF) minutes (whichever is sooner). The net material is easily cut by any blade the target has in hand. [*Chromebook 2*]

**WIRE NET W/TASER CHARGING: +100EB TO BASIC COST**

A carbosteel wire net attached to an integral taser unit. (Use Taser rules in *CP2020*.) Wire net can only be cut by mono-edge weapons and chain-blades. Accuracy and range for carbosteel net and Det-Web are +0/25m.

**FEN DZ-55 DET-WEB: 450EB/ONE-USE NET**

Designed as new anti-'borg projectile; the net's nylon strands have been replaced with pieces of Detcord. When triggered, Detweb does 40 points of AP damage to every body location.

**Skunker™: 70eb**

EX -1 P E VARIES (GAS) 4 1 VR 2M

Armament for the non-violent person. Delivers up to 4 doses of non-lethal gas (purchaser's choice) to a target 2m away. One target only, but enough to discourage any allies he/she may have. At 15cm long and 3cm around, it fits in any purse or jacket pocket. Comes in 6 designer colors. For 5-10 eb more, the gas can be mixed with odoriferous chemicals, creating additional effect equal to Stench Bomb (see entry). See the Gas rules in *CP2020* for details. [*Chromebook 2*]

**Streettech "Burst": 33eb**

SHT VAR P E 2D6+1(28GA.) 1 1 VR 3M

The latest in self-defense weapons from StreetTech. The Burst looks like a small flashlight. It is triggered by unlocking its built-in safety mechanism and thumbing the switch, which electronically detonates the weapon's propellant and fires its payload of pellets. Designed to rapidly lose their destructive power, these pellets are ineffective beyond 3m (-1 accuracy at 0-1m, -2 at 1-2m, -3 at 2-3m). Originally designed as an emergency hideout weapon for police officers, StreetTech has recently re-packaged this design for public consumption, producing Burst models with designer key rings for the up-and-coming executive wanting that hidden defense (40eb each). [*Protect & Serve*]







**Techtronica 15 Microwaver: 400eb**

P 0 J P 1D6 10 2 VR 20M

Flashlight sized microwave projector. See CP2020 for details. [Cyberpunk 2020]

**Techtronica 20 Microwaver: 500eb**

P 0 J P 1D6 15 2 VR 25M

Enhanced version of the Techtronica 15 microwaver. This version has a higher shot capacity and a better range. See CP2020 for rules governing microwavers. [Chromebook 2]

**Techtronica Black-Zap Glove: 90eb**

EX 0 P C STUN 6 1 ST 1M

An electrified mesh glove with effects equal to a taser, powered by an armband battery pack. The Black-Zap can be used with either a grab or a punch attack. [Chromebook 1]

**Techtronica M40 "Pulse Rifle": 3500eb**

RIF 0 N R EMP EFFECT 6 1/2 ST 50M

This stubby, rifle-shaped weapon (using liquid metal storage cells) is fully insulated against its own multi-band, beam propagation effects.

**PEOPLE**—Point Blank: Death Save at -3, success is unconsciousness 2D6x30 min; Close: Stun Save at -5, failure is uncon. 1D6x10 min; Medium: Stun Save at -3, failure is uncon. 2D6 min; Long: Stun Save at -1, failure is uncon. 1D6 min; Extreme: Stun Save, failure is unconscious for 1D6x10 sec.

**EQUIPMENT/CYBERWARE**—Point Blank: Automatic permanent breakdown if unshielded, 50% chance if shielded; Close: Automatic permanent breakdown if unshielded; Medium: Automatic breakdown for 1D6/2hrs if unshielded; Long: 70% chance breakdown for 2D10 min if unshielded; Extreme: 30% chance breakdown for 1D10x10 sec if unshielded. [Chromebook 2]

**Techtronica Model 009 Volt Pistol: 950eb**

P +1 J R 3D6 (ELECTRICITY) 6 1 ST 25M

Inside the sleek metallic frame of the Volt Pistol is a low-intensity laser projector, which ionizes the air when fired. Then the 009's high capacitance liquid metal batteries release an electrical charge along the path, resulting in an artificial "lightning bolt." The resulting damage is half real and half stun. Any cyberlimb hit will be shorted out for 1D6+3 x10 sec (if a critical hit is rolled, the damage is permanent). If the limb is shielded, there is still a 20% chance of shorting. Even if hit in a flesh part, any adjacent non-limb cyberware is affected as if hit by a Microwaver with a +2 on the effects table. Non-grounded armor gives no protection vs. the gun's effects. The Volt Pistol is comparable in size to a medium SMG and is powered by a removable power pack (25eb for fresh packs). [Chromebook 2]

**Tsunami Arms "Airhammer" Air Pistol:**

**325eb (Solo model), 400eb (Security model)**

P +1 J VAR SPECIAL (5.3MM) 5/7 2 ST 50M

An unusual design by Tsunami for the Crystal Palace security force. The Airhammer fires a 5.3x19mm projectile via compressed air, which is controlled by 3 settings: Target, Combat, and Overload. "Target" setting gives 1/2 damage; high performance is not necessary. "Combat" is the normal setting; no modifiers are applied. On "Overload", the weapon's reliability drops to UR, and damage is +3. The Airhammer's air reservoir holds 15 units of fire; "Target" setting uses 0.5 unit, "Combat" setting uses 1 unit, "Overload" uses 3 units. Replacing the reservoir is a 10 sec operation, requiring a 15+ REF roll to keep from dropping the small part; this can be avoided by taking 20 sec. Available in two versions: Solo model has 5 round magazine, laser sight, 10-shot gun-camera; Security model (Mk.2) has 7-round magazine, smartgun rig. [Chromebook 2]

**AMMO LIST:**

**Kendachi Frag Flechette:** 1D6+2 explosive ceramic darts. See entry for details.

**Normal Flechette:** 1D6+2AP (soft armor x1/4). Special plastic shatters against walls or hard armors.

**JellSluggs:** 2D6+2. Treat as rubber bullets. See entry for details.

**Gas Capsule:** Throws 2m diameter gas cloud on impact. Effects depend on gas type.

**Practice:** 1D6-1. Uses plastic slug.

**Tsunami Arms Underbarrel Capacitor Lasers/Microwavers: 950eb/500eb**

**UNDER-BARREL CAPLASER:** RIF +2 \* R 3D6 2 2 UR 25M

**UNDER-BARREL MICROWAVER:** EX 0 \* P 1D6+SPECIAL 4 2 ST 20M

Advanced weapons from the geniuses at Tsunami Arms, these capacitor weapons negate the need for bulky power units by using advanced superconducting packs instead. They are designed to fit under Medium SMGs to Rifles. Hip Power Pack, 250eb. This gives you double the number of shots (and +5m to the microwaver range), for only 4kg of weight. [Chromebook 2]



**UrbanTech "Lance" Mini-Missile: 100eb**

URVY +2 P C 4D6(HEAT) 1 1 UR 300M

Need an effective defense against tough attackers, but don't want to tote around a cannon? If so, the Lance is for you. The UrbanTech Lance is a personal mini-missile weapon. It consists of a single missile with breakaway protective case. The weapon is armed by breaking the case, pointing it at the target, clicking the activation button, and pushing it away from the firer. Use INT as the base To Hit stat instead of REF (this determines that you've pointed it correctly). The Lance's engine will kick in a safe distance from the launcher and seek the target (minimum range: 10m). The missile inflicts 4D6 damage to the target; 2D6 in a 1m diameter. (Note: This is a HEAT warhead; SP is halved, damage is not.) If the Lance misses, it has a 50% chance to correct and make a second To Hit roll with a 0 WA. [Solo of Fortune 2]

# LIGHT HANDGUNS

Unless otherwise noted, all weapons use caseless ammo.

**Astra Style-6: 75eb**

-1 P E 1D6 (5MM) 6 2 UR 50M

Ubiquitous (and cheap) Spanish polymer one-shot firing 5mm fragmenting plastic rounds. [Eurosource]

**BudgetArms C-13: 75eb**

-1 P E 1D6 (5MM) 8 2 ST 50M

Light duty autopistol used as a holdout and "lady's gun." [Cyberpunk 2020]

**Dai Lung Cybermag 15: 50eb**

-1 P C 1D6+1 (6MM) 10 2 UR 50M

Cheap Hong Kong knockoff, often used by boosters and other street trash. [Cyberpunk 2020]

**Federated Arms Impact: 60eb**

+1 J E 1D6 (.22) 10 2 VR 50M

One-shot, low caliber pistol with good reliability. [Solo of Fortune]

**Federated Arms X-22: 50-150eb**

0 J E 1D+1 (6MM) 10 2 ST 50M

The ubiquitous "Polymer-one-shot" cheap plastic pistol. Available in 13 designer colors. Also comes in .22 caseless load (1D6 damage, 25-50eb). [Cyberpunk 2020, Solo of Fortune]

**Federated Arms X-38: 35eb**

+1 J E 2D6 (.38) 10 2 ST 50M

Expensive .38 caseless automatic. [Solo of Fortune]

**Howa Manufacturing Type-12 Police Pistol: 450eb**

+3 J P 1D6+1 (6MM) 6 2 VR 50M

Standard handgun for Japanese policewomen. High-rankers also use this gun. It's designed to stop or intimidate criminals. This is an incredibly reliable revolver. A smartgun type is also available for those with the link (WA+5; 810eb). [Pacific Rim]

# MEDIUM HANDGUNS

Unless otherwise noted, all weapons use caseless ammo.

**Arasaka WSA Autoistol: 400eb**

0 J C 2D6+3 (10MM) 15 2 VR 50M

Standard issue sidearm for all Arasaka troops, as well as executives who want to pack a little punch. [Corpbook 1]





**BudgetArms C-41: 600eb**

P +1 J E 2D6+1 (.41 C) 10 3 VR 50M

Ten shot, high-caliber pistol with good reliability. [*Solo of Fortune*]

**BudgetArms Laser-Niner: 675eb**

P +1\* J/L P 2D6+1 (9MM) 15/35 3/20 ST 50M (\*INTEGRAL LASER SIGHT)

A quality auto/machine pistol, sleek in design, which fires 9mm caseless rounds. Made to security specifications, it is built for combat, employing an integral lasersight and 3 round burst/full-auto firing mode. It has a 15-shot magazine, but for assault ops it can be fitted with a 35-round "snail" clip (concealment rating goes up to "L" when the snail clip is loaded). [*Chromebook 1*]

**Beretta M97P: 480eb**

P +2\* J P 2D6+1 (9MM) 18 2 VR 50M (\*INTEGRAL LASER SIGHT)

The latest development of the 92: an advanced pistol with integral underbarrel laser sight, much used in the EuroTheater. Uses plasticased ammo. [*Eurosource*]

**CCMMC Goaxing Xiuxi CM-3: 250 YY (75eb)**

P 0 J C 2D6+1 (9MM) 8 2 ST 50M

The civilian market pistol which is the maximum firepower that a civilian can legally own in Mainland China. Not available outside China. [*Pacific Rim*]

**Colt Alpha-Omega Competition Pistol: 500eb**

P +2 J C 2D6+2 OR 2D6+3 10 2 VR 50M

For over a century, Colt Firearms has been producing, and improving, the definitive semiautomatic pistol. From the M1911a1 .45 Colt to the present Alpha-Omega, Colt has strived for excellence. The Alpha-Omega is a semiauto, double-action pistol. It has a ten round magazine in the shooter's choice of .45 ACCP or 10mm caseless. The pistol comes with a barrel compensator and shooter's interface as standard factory options. It may also be ordered with a Nikon COT sight system (*Solo of Fortune*) for an additional 3900eb. [*Chromebook 1*]

**Colt Enforcement 10 Sidearm:**

**550eb basic, 600eb camouflaged, +550eb smartchipped**

P +1 J C 2D6+3 (10MM) 14 2 VR 50M

This is Colt Firearms latest addition to its venerable line of automatic pistols. As its name suggests, the Enforcement 10 is targeted toward the military and law enforcement markets. Like the .45 auto, the Enforcement 10 is built on a solid, heavy frame which helps to absorb the recoil of the potent 10mm round. The receiver and slide are fashioned from Sortex™, a tough, high-density ceramic composite developed for use in firearms manufacture. (Sortex™ is also used by Arasaka, Militech and Glock Firearms.) The Enforcement 10 is the standard sidearm for Petrochem's security guards, soldiers, and naval personnel. It is corrosion and dirt-resistant and extremely reliable. Standard models come in matte black, blued metallic and marine stainless finishes. For an extra fee, the matte black Sortex™ receiver and slide can be made in one of several camouflage patterns. The patterns are part of the Sortex™, and will not wear off. [*Corpbook 3*]

**Dai Lung Streetmaster: 200eb**

P 0 J E 2D6+3 (10MM) 12 2 UR 50M

Another Dai Lung cheapie, built for the Street. [*Cyberpunk 2020*]

**FN Browning "3-Spot" Machine Pistol: 425eb**

P +1 J C 2D6+3 (10MM) 24 3 ST 50M

The 3-Spot machine-/autopistol is designed for law enforcement duties in the more dangerous parts of Europe. Set for purely accurate fire suppression, the pistol with each pull of its trigger unleashes a three-round burst of 10mm caseless slugs. The magazine holds 24 rounds, allowing eight shots. This pistol is in use in the U.K., France, Belgium and Italy. [*Rough Guide UK*]

**Federated Arms X-9mm: 300eb**

P 0 J E 2D6+1 (9MM) 12 2 ST 50M

A sturdy Solo's gun, used as a standard state militia sidearm in the U.S. [*Cyberpunk 2020*]

**Fashion Gun 9: 35-40eb**

P 0 P E 2D6+1 (9MM) 7 2 UR 25M

Lightweight pistol, common to many of the Poser set. Emptying the magazine will cause the barrel shroud to melt and slough off the weapon like hot cheese. At this point, the gun jams permanently. (In game terms, firing a full magazine load within 7 combat actions cause the gun to jam automatically.) The plastic is truly inferior, and inappropriate to the job it was used for. You get what you pay for, though. [*Solo of Fortune*]



**Goncz-Taurus Pistol: 200-275eb**

P	0	J	E	2D6+1 (9MM)	15	2	ST	50M
---	---	---	---	-------------	----	---	----	-----

**SELECTIVE-FIRE VERSION: 300-400EB**

SMG	-1	J	C	2D6+1 (9MM)	15/30	2/10	ST	50M
-----	----	---	---	-------------	-------	------	----	-----

Standard officer-issue weapon in the Pan-Américas, and for many years illegally smuggled into the southwestern United States, this pistol has been made famous by that notorious nomad gang, the Bat People. The G-T Pistol is manufactured by Taurus Brasilia de Brasil to their exacting standards and is imported by De Santos Ltd. Two versions of this weapon are available: the 9mm semiautomatic, and the machine pistol version with a selective fire capability. A choice of fifteen or thirty round magazines is available. Dealers' prices vary. [*Chromebook 1*]

**Glock Thirty Machine Pistol: 705eb**

P	+2	J	C	2D6+3 (10MM)	20/30	1/3	VR	50M
---	----	---	---	--------------	-------	-----	----	-----

Glock Int. introduces the latest in the further development of their famous line of semi-auto pistols. Glock has taken their 10mm Glock-20, given it a selective single shot or three-round burst capability, gas porting on the barrel for excellent controllability, and thirty 10mm cartridges per magazine. Note: This pistol can also use the standard 20-round pistol magazine, making it slightly more concealable and compact (P). [*Chromebook 1*]

**Hammer M-11 Bolt Pistol: 320eb**

P	+2	J	P	1D6+2 (9MM BOLT)	10	2	ST	30M
---	----	---	---	------------------	----	---	----	-----

The most common bolter in use, the M-11 has better recoil control than most flechette weapons. Armor is x1/4, damage x1/2, due to the 9mm bolt's high penetration. [*Deep Space*]

**IMI Gamad: 575eb**

P	0 (+1*)	P	E	2D6+3 (10MM)	7	2	VR	50M	(*W/LASERSIGHT)
---	---------	---	---	--------------	---	---	----	-----	-----------------

This stubby 10mm pistol gets its name ("Dwarf") from its small size. First designed for the Mossad, the Gamad was only released onto the foreign market in the last three years. The weapon comes with a lasersight only, but a smartgun variant is available. This is the weapon that Mossad agents have come to be known by. These pistols are also popular as back-up weapons. An extended 15-round mag is also available (35eb, raises concealment to J). [*Solo of Fortune 2*]

**Kang Tao Type 97: 35eb**

P	+1	J	E	2D6+1 (9MM)	10	2	UR	50M
---	----	---	---	-------------	----	---	----	-----

Famous 9mm Beretta copy. Common polymer one-shot in South America. [*Solo of Fortune*]

**LeRoi Maxi-10: 150eb**

P	-1	J	E	2D6+3 (10MM)	10	2	UR	50M
---	----	---	---	--------------	----	---	----	-----

A French automatic with an undeserved street reputation, built largely on its macho chunky styling and clever marketing. [*Eurotour*]

**Militech Arms Avenger: 250eb**

P	0	J	E	2D6+1 (9MM)	10	2	VR	50M
---	---	---	---	-------------	----	---	----	-----

A well made autopistol with good range and accuracy; a professional's gun. Since 2005, the Militech Avenger 9mm pistol has been the standard sidearm of the U.S. military machine. It's a good, solid pistol with a proven record. Issued mainly to rear-area officers and MPs due to its lack of body armor-penetrating ability. [*Cyberpunk 2020, Corpbook 2, Home/Brave*]

**Militech Black Widow Flechette Pistol: 400eb**

P	+1	J	P	VARIES (FLECHETTE)	10	2	ST	30M
---	----	---	---	--------------------	----	---	----	-----

The "Widow" was designed under contract with the U.S. Air Force as a standard space sidearm, especially for EVATs (EVA Troops, the USAF Special Ops unit). The idea was to create the potential for a great deal of damage with low penetration/recoil for use in enclosed environments. Ammo feeds from a somewhat bulky 10-round clip. Each round has 10 flechettes with a one meter spread at Medium range (roll hit locations as per a shotgun). Flechettes do 1/2D6 (armor is x1/2) damage, plus any drugs added. Uses cased ammo. [*Deep Space*]

**Militech Silver Shadow Flechette Pistol: 300eb**

P	0	J	P	VARIES (FLECHETTE)	8	2	ST	30M
---	---	---	---	--------------------	---	---	----	-----

The civilian ancestor of the famous "Black Widow" developed for the USAF. Each shotgun-like shell has 6 flechettes with a half-meter spread at medium range; roll (1/2D6)+2 to see how many hit per shot. Each hit does 1D6/3 (armor is x1/2) damage at all ranges, plus any drug or poison added. Only seen in the Orbital habitats. Uses cased ammo. [*Deep Space*]

**Nomad .357 Magnum Autoloader: 300eb**

P	0	J	C	2D6+3 (.357MAG)	8	2	VR	50M
---	---	---	---	-----------------	---	---	----	-----

Based on the Colt M1911, this pistol is sturdy and user-friendly. It uses a standard box magazine; reloading takes one round. Standard hot loads do 3D6+1 damage; see below. Uses cased ammo. [*NeoTribes*]





**Nomad .357 Magnum Revolver: 250eb**

P 0 J C 2D6+3 (.357MAG) 6 2 VR 50M

The .357 Magnum cartridge is ideally suited for matched rifle and pistol use. "Magazines" for this weapon are usually two three-round "half-moon" carriers that can be easily loaded and removed. Reloading takes one round if using half-moons, three rounds without. This cartridge is somewhat downloaded so adolescents can handle it; standard hot loads do 3D6+1 damage. Uses cased ammo. [*NeoTribes*]

**Sci Fi Starrior 4: 60eb**

P 0 J E 2D6+1 (9MM) 12 2 UR 50M

Polymer one-shot blaster copy from a 20th century movie called *Star Trek Wars*. [*Solo of Fortune*]

**Stein & Wasserman "Tri-Star" Revolver: 275eb**

P +0 J C VARIES (.410GA) 6 2 ST 50M

S&W designed this special-load revolver as a "compact yet practical multi-munitions delivery system." What this means in plain English is that the Tri-Star is a big, double-action revolver-style handgun which fires .410 shotgun ammo. Although it is capable of firing shotshells (2D6/1D6+2/1D6) and slugs (3D6+1), the Tri-Star is best known for loading Triplex shells which pack three #000 buckshot pellets (2D6 damage each). When using this load, treat each shot as a "3-round burst," rolling 1D6/2 to see how many buckshot hit and then rolling each hit randomly. Stein & Wasserman also markets a 100eb lasersight which is specially made for Tri-Stars packing the #000 Triplex: The sight projects a red dot which marks the point of aim, and a surrounding circle which marks the area into which the three pellets will spread. Because of the visually distinct style of these sights, the Tri-Star has seen a great deal of use in media entertainment. [*Chromebook 2*]

**Stermeyer P-41 Autoloading Pistol: 425eb**

P 0 J C 2D6+3 (10MM) 12 2 VR 50M

A lighter pistol common among IEC executives who want something a little easier to handle and with a greater magazine capacity than the hefty P-35. [*Corpbook 1*]

**Stolbovoy St-2 Pistol: 450eb, 850eb smartchipped**

P 0 J C/R 2D6+3 (10MM) 14 2 VR 50M

Continuing Stolbovoy's tradition of extremely durable and reliable weapons, the St-2 is a handgun built with a composite slide and receiver and a patented action that virtually cleans itself of dust and grit. Uses cased ammo. Note: On the FNFF reliability table, Stolbovoy weapons jam only on a roll of 1. Also, all Stolbovoy weapons are Common in the Soviet Union and Eastern Europe, and Rare in the U.S. [*Corpbook 3*]

**Surprising Stranger: 15-50eb**

P 0 P E 2D6+3 (10MM) 4 2 ST 25M

Four-shot, pepperbox design. One of the most reliable of the polymer one-shots. Muzzle loaded (1 round per combat turn), with a silent electric trigger. A good holdout gun. [*Solo of Fortune*]

**Teen Dreem: 36eb**

P -1 J E 2D6+1 (9MM) 10 2/10 UR 50M

Ten-shot pistol with full auto capacity. Tends to melt under full autofire (60%). [*Solo of Fortune*]

**Texas Arms Model-351 Gyrojet Pistol: 420eb**

P 0 J C/P 2D6+1 (9MM Gyro) 8 2 UR 50M

Developed as a lightweight gyrojet weapon along the lines of the earlier Mark II models of the 20th century, the 351 pistol fires a 9mm rocket round. Range is 3x that of a normal pistol in vacuum. The 351 is a commonly used military firearm, particularly on Luna, but is rarely seen Earth-side. See Ammunition section for further info. [*Deep Space*]

**Towa Manufacturing Type-13 Police Pistol: 500eb**

P +2 J P 2D6+3 (10MM) 12 2 VR 50M

The standard autopistol for Japanese patrol cops. NPA developed this gun to deal with an increase in foreign cybered criminals. Because it frequently kills or cripples non-cyber targets, the gun is feared by NPA officers as a "Blackmark Maker." On request from patrol officers, NPA began developing a non-lethal rubber bullet (see *Chromebook 2*) around 2018. A smartgun system is available for those with the link (WA+4, 800eb). [*Pacific Rim*]

**Towa Manufacturing Type-14 Pistol: 520eb**

P +2 J P 2D6+1 (9MM) 16 3/16 VR 50M

The standard autopistol for Japan's SDF soldiers. Officer version comes with smartgun system installed (WA+4, 820eb). 3 round burst or full-autofire standard. [*Pacific Rim*]



**Tsunami Express Racegun: 5300eb**

P +3 L P 2D6+3 (5.2MM ET) 24 3 VR 5M

Designed with the professional competitor in mind, the Express is a 5.2mm electrothermal design that gives the ammo capacity of a Minor class gun with the muzzle velocity and hitting power of the Major calibers. Ergonomic design, computer-controlled tolerances, a custom barrel compensator, and one of the best, most stable, rounds to come out of our munitions lab all combine with a Zeiss-Nikon COT scope to become one of the most accurate handguns on the market today. Perfect for the competitor who doesn't want to be slowed down by his sidearm. 5.2mm ammo costs 50eb per box of 50. A battery (good for 50 shots) is 10eb. Notes: The Express isn't really designed to be concealable; the "L" is being generous, but if someone changes the grip (dropping the WA to +2, costs 125eb), it can be done. Because of the barrel compensator's design, this gun cannot be fitted with a suppressor. The Express is a racegun, not a combat monster, and its design reflects that: lots of satin-polished chrome steel, real wood grips, 125lpi checkering on the grips and frontstrap. The battery is loaded into the back of the gun, under the partial slide; the magazine is in the pistol grip. The wood grips feature a wrist support and ergonomic design. COT scope is attached to the frame, ahead of the slide. There are three adjustable weights under the barrel in front. Overall length of the gun is 36cm. [*Solo of Fortune 2*]

**Wondernines: Price Varies**

P +1 J E 2D6+1(9MM) VARIES 2 VR 50M

All 21st-century "wondernines" are pretty much the same: relatively accurate, firing caseless 9mm ammo; semi-automatic, and easy to get hold of. In game terms, all wondernines have the same stats except for name, shots and price: roll 1D6 and add this to 14 to determine the shots per magazine, and add (the same number you rolled on your 1D6) x10 to 240eb to determine the price in Eurodollars. The following are some of the most widely-sold modern wondernines: Constitution "Bronco," Daewoo DP17, H&K P-18, IMI's Gideon, Militech's A226, S&W M2009 and the Walther 915. [*Solo of Fortune 2*]

# HEAVY HANDGUNS

**Unless otherwise noted, all weapons use caseless ammo.**

**BudgetArms Auto-3: 350eb**

P -1 J E 3D6 (11MM) 8 2 UR 50M

It's cheap. It's powerful. It blows up sometimes. What else do you want? Note: On a fumble/jam, there is a 10% chance of explosion; 2D6 damage to firer's arm. [*Cyberpunk 2020*]

**Jai Lung Magnum: 60eb**

P 1 J E 3D6+1 (.357MAG) 10 2 UR 50M

Automag copy commonly used by cheap hoods. Note: If gun jams/fumbles, it has a 60% of injuring the firer, doing 2D6+1 to the firer's arm. [*Solo of Fortune*]

**Espinoza One Shot: 75eb**

P -1 J E 3D6 (.50 SHORT) 1 1 UR 50M

One shot, heavy caliber. Tends to explode (60% chance; 2D6+1 damage) on a misfire or jam. [*Solo of Fortune*]

**Malorian Arms Heavy Flechette Pistol: 595eb**

P +1 J C 1D6+1 (4MM) 25 2 ST 50M

Firing a single 150 grain, 4mm dart at over 1700 feet per second, the Malorian Arms heavy flechette pistol is second to none in flechette handgun technology. Using a liquefied gas combustion system, this semiautomatic pistol packs a serious wallop in a handgun-sized package. The rechargeable liquid propellant reservoir can fire over two hundred rounds before needing a refill (30eb). The large magazine capacity makes this weapon a favorite with firepower freaks everywhere. Eran Malour has specifically designed his new flechette gun with the "enhanced" customer in mind. The weapon comes chipped from the factory, safely interlocked and encoded to the owner, so use by anyone else is impossible. This feature is a definite plus to anyone needing a strong home defense weapon, but who worries that children might hurt themselves with an accidental discharge. Note: Dense metallic bolt has double the AP effect (armor is x1/4, but damage is normal). User must wear a special "safety-chipped" wristband, or have the safety chip in a wrist socket. Disposable magazines are 14eb. Weapon is rated "Heavy" for its size, not damage. [*Chromebook 1*]





**Mustang Arms "Mark II": 425eb**

P +1 J/L C 3D6 (11MM) 12/20 3 VR 50M

The Mark II is a powerful autoloader machined to very close tolerances. Using the latest computer-aided design techniques, the Mark II is ergonomically and technically advanced. It sports a 16.5cm barrel with a ported compensator, but its most unusual feature is the magazine: Although a standard 12-round clip is available, each Mark II comes with a 20-round "banana" mag. This handgun is popular with many police units for its "staying power"—that is to say, magazine capacity. Patrol officers commonly carry five twelve-round magazines of 11mm AP, plus one up the spout; the banana clip is normally used by SWAT, entry teams, and military special-ops units. Note: The tolerances are a little too tight. If the gun is dropped on a hard surface, Reliability drops to ST; if the weapon goes more than one day without cleaning in a "dirty" environment, Reliability drops to ST. Reliability also drops one level for every 24 rounds fired without cleaning. [*Solo of Fortune 2*]

**Nova Model 338 Citygun: 460eb**

P +1 J P 3D6 (.338) 7 3 VR 50M

The double-action Citygun is Nova Arms' attempt to bring the revolver up to date. Rather than employing a traditional cylinder, it uses Nova's patented "Ammo Cassettes." These are disposable cylinders composed of superstrong composite ceramics preloaded with seven .338 Nova cartridges. To reload, one simply drops out the empty cassette and slaps in a fresh one, thus doing away with clumsy reloading of individual rounds. The Citygun is packed with modern features, sporting a nonreflective matte black finish, a octagonal barrel which has an underbarrel universal scope-mount, an adjustable trigger, and twin triple-porting on the barrel which serves as a sophisticated muzzle compensator (the compensator aids in quick recovery for follow-up shots, increasing the ROF to 3). The most striking feature is the weapon's layout—the cylinder has been positioned in front of the trigger group, creating a straight-line barrel-arm sight picture, and giving the gun an almost autopistol look! Nova also includes two spare ammo cassettes with every Citygun. Durable, reliable, and capable of placing seven high-velocity slugs in a two-inch pattern as fast as you can pull the trigger, the Citygun is indisputably the most advanced wheelgun on the market today. Note on .338 Nova: This rimmed, brass-cased cartridge is calculated to fire between .357 Magnum and 10mm Auto, making it an ideal mid-range load. Ammo is available for 15eb (per box of 50 rounds), and disposable Ammo Cassettes are available for 5eb each. However, pre-loaded, plastic shrink-wrapped Ammo Cassettes are available off the shelf for 7eb each. [*Chromebook 1*]

**Nova Model 757 Cityhunter: 480eb**

P +2 J P 3D6 (11MM) 18 2 ST 50M

An unusual double-action design from Nova Arms, a company with a long-time fascination with futuristic revolvers. The Cityhunter can be classified as a revolver—almost. The Nova design strays from revolver conventions in several ways: the Cityhunter fires 11mm caseless "trounds" (that is, each cartridge's bullet is embedded in a triangular propellant block). These trounds load into the Cityhunter's internal cylinder, which is completely enclosed within the tubular body of the gun, set above and in front of the trigger. Unlike the traditional revolver, the Cityhunter's cylinder does not have enclosed chambers. They are open on the outer surface, allowing each tround, as the cylinder revolves, to drop down into the breach, located directly under the cylinder. Within the breach is an electrical igniter, which fires the tround's propellant. The barrel of the gun is positioned in-line with the trigger (and thus the firer's hand), reducing recoil and making the gun easier to fire. To aid in aiming, the Cityhunter has an integral laser sight, mounted along the centerline of the tubular portion of the gun. Ahead of the cylinder, the shaft is surrounded by another 2 loads (12 rounds). When all six trounds in the cylinder have been fired, one racks the slider (located on the exterior of the tube) back one index to move the next six rounds into the cylinder; when those six trounds have been fired, rack the slider again to load the last six trounds. If smartchipped, this process can be activated through the chipping. To fully reload the tube (18 trounds), one presses a recessed release switch beneath the laser sight and pulls the cap off the front of the gun. One can then load new trounds into the tube—Nova manufactures a speedloader for this gun to facilitate this (25eb each, ammo extra). [*New for this Volume!*]

**Stein & Wasserman Bi-Power Handcannon: 850eb**

P +0 J/L P 4D6 (.44 MAG) 6 2 UR 50M  
P +1 J/L \* 2D6+2 (.45 ACP) 10 2 UR 50M

After a long wait, Stein & Wasserman's "Bi-Power" is now commercially available! Following a previously unheard-of design philosophy, this hybrid handgun mates a double-action .44 Magnum revolver to a .45 ACP autoloader. The sturdy grip holds 13 rounds of .45-caliber ammo in a double-column magazine, feeding into the upper portion of the gun. The automatic's long slide ends in a compensator, but (because it's built into the frame beneath the barrel of the automatic and ahead of the trigger assembly) the revolver's barrel is somewhat snubby. "R" (revolver) mode or "A" (automatic) mode can be selected at the flip of a thumb-switch. Although many complain that the choice of brass-cased ammo for both barrels makes the weapon less reliable, the Bi-Power rarely malfunctions. The Bi-Power's worst problem is its size—packing a .45 auto with an 22cm barrel and a .44 Magnum wheelgun into one package makes this handcannon "L" concealability for anyone with a BOD of less than 8. [*Solo of Fortune 2*]

**Sternmeyer P-35: 400eb**

P 0 J C 3D6 (11MM) 8 2 VR 50M

Rugged, reliable, with excellent stopping power. Another fine E.C.C. product from the United Germanies. The standard issue sidearm in many Euro-corp guard forces, and the pistol of choice among IEC executives. [*Cyberpunk 2020, Corpbook 1*]





**Tsunami Arms "Raimei" Ramjet pistol: 1100eb smartchipped; 3200eb for COT variant**

P +2 L P VAR (10MM RAMJET) 6 2 VR 100M

Following close on the heels of our successful Ramjet Rifle is the Raimei (Thunderclap) pistol. Designed for urban combat against PA suits and 'borgs, the Raimei fires a slightly larger 10mm bullet; this design allows for faster acceleration to full speed, but a lower range to avoid damaging incidentals. Each round costs 30 eb; one loaded clip is included in the cost of the gun. The Raimei comes standard with a Maboroshi smartgun link or Zeiss-Nikon COT, plus security chipping to prevent unauthorized use.

Note: The 10mm Ramjet does 5d6 at Close range, 6d6+3 at Medium, 7d6 at Long range, and 7d6+1 at Extreme range. Armor SP is x3, and penetrating damage is doubled since it is effectively a large hollow-point round. [*Solo of Fortune 2*]

# VERY HEAVY HANDGUNS

Unless otherwise noted, all weapons use caseless ammo.

**454 Magnum Disposable: 100eb**

P -2 P R 4D6+3 (.454) 2 1 VR 40M

The deadliest of the polymer holdouts. Famed for its reliability (and rarity). A pull tab opens the over/under barrels and activates the permanently-sealed battery. Uses electrically-fired caseless ammo; non-reloadable. Made from reinforced carbon fiber composites.

Note: placed in this category due to its power; in size, it is a Light Pistol. [*Interface Magazine, Vol.1, #1*]

**Ameritech Magnum: 1000eb**

P +1 J R 4D6+3 (.454) 5 2 VR 50M

A classy heavy revolver from Ameritech Arms, with steel-reinforced ceramic construction. Engineered for rapid target reacquisition, and capable of being laser-sighted or smartchipped. By special order only. [*Interface Magazine, Vol.1, #1*]

**Armalite 44: 450eb**

P 0 J E 4D6+1 (12MM) 8 1 ST 50M

Designed as an alternate to the 1998 U.S. Army sidearm trials. A solid contender. [*Cyberpunk 2020*]

**Colt AMT Model 2000: 500eb**

P 0 J C 4D6+1 (12MM) 8 1 VR 50M

Now the standard officer's sidearm for the U.S. Army, the AMT 2000 served well in the Central American Wars. This workhorse has served for over twenty years, but it still has a solid knock-down capability vs. the newer, heavier personal armors. As of 2019, field officers and vehicle crews are being given a choice of issue sidearms—either the AMT 2000 or the quicker and more accurate Alpha-Omega in 10mm. [*Cyberpunk 2020, Home/Brave*]

**Constitution Arms Multi-Ammunition Pistol: 525eb**

P 0 J P VARIES (12MM) 5 1 VR 50M

Designed by Constitution Arms to take advantage of advances in the field of ordnance technology, this revolver is designed to offer the user a choice between lethal and non-lethal response to a situation. The standard model is equipped with a rapid selector switch (to select between rounds before firing) and a readout display under the rear sight, which informs the user of the round selected. Smartchipped models give the user direct control over selection, and round information is provided directly to the user (requires Time Square Marquee). Being a revolver, it uses cased ammo; see the Ammunition section for further details. [*Protect & Serve*]

**Federated Arms 454 DA "Super Chief": 375eb**

P 0 J P 4D6+3 (.454) 5 1 VR 50M

Originally conceived with handgun hunters in mind, the Super Chief is a double-action revolver finished in stainless steel and chambered for the .454 Casull, a cutdown big-game cartridge specifically designed for large animals. A big success with people who like the challenge of handgun hunting, this weapon has also proven itself as a real manstopper when the situation warrants. It's also a very popular Nomad weapon. [*Chromebook 1*]

**Malorian Arms 3516: 4525eb**

P -1 J R 6D6 (14MM) 6 1 VR 50M

The most powerful personal handgun on the market today, Eran Malour developed this radical new design to the personal specifications of famous rocker Johnny Silverhand. "I wanted something that would drop a cyberpsycho'ed fan at 100 paces, no matter how





metalled up he was," explains the enigmatic singer. "Price was no object." Malorian's design employs a rare, solid Orbital titanium frame, custom Dyna-porting® and a direct cyber interlink that locks the user's cyberarm in place as the weapon fires (required: cyberarm of Average Body Type, interface plugs, smartgun link). By special order only. [Chromebook 1]

### Militech .477 Boomer Buster: 450eb

P +1/-1 J/L P 5D6AP (.477) 4 1 VR 50M

Now, a close-in support weapon that can stop a cyberpsycho cold; nearly an express rifle in design! A 4-chamber, pepperbox-style gun, with a folding arm brace for support. Note: Acc and Conceal drop unless firer has the brace deployed, or a cyberarm. [Solo of Fortune]

### Nomad .44 Magnum Revolver: 375eb

P 0 J P 4D6 (.44) 6 1 VR 50M

Usually carried by Nomads using the .44 lever-action rifle, it is based on the classic large-frame Smith & Wesson and Colt revolvers. Uses cased ammo. [NeoTribes]

### Nova Arms Plasmatic™ Revolvers

By its very nature, the revolver MUST use cased ammunition (as rimmed cases are needed to hold the cartridges in a revolver's cylinder). Now, electrothermal technology has breathed new life into the aging wheelgun. Always the most reliable of weapons designs, the revolver once again earns the title of Most Powerful, thanks to the wizardry of electrothermal weapon enhancement! Nova Arms now offers you Plasmatic™ revolvers—complete with electrical firing system and grip-housed power cells. Plasmatic™ Electrothermal Ammunition (cased ammo) is available exclusively from Nova Arms: 75eb for 50 rounds. 24-shot grip batteries sold separately; 50eb each. 100-shot hip packs: 100eb each. Moisture-proofing and insulation extra. [Solo of Fortune 2]

#### NOVA ARMS "STALLONE" .357 PLASMATIC™ MAGNUM: 999EB

P +1 J P 4D6 (.357) 6 2 VR 60M

#### NOVA ARMS "BRONSON" .41 PLASMATIC™ MAGNUM 1199EB

P +1 J P 5D6 (.41) 6 2 VR 80M

#### NOVA ARMS "EASTWOOD" .44 PLASMATIC™ MAGNUM: 1499EB

P +1 J P 6D6 (.44) 6 2 VR 80M

#### NOVA ARMS "ARNO" .454 PLASMATIC™ MAGNUM: 1799EB

P +1 J P 6D6+3 (.454) 6 2 VR 100M

### Royal Enfield Ordnance Spitfire 12mm Battle Pistol: 550eb; 700eb smartchipped

P +1 J P 4D6+1(12MM) 12 1(2) VR 50M

The Royal Enfield Ordnance Spitfire battle pistol is a high quality long-slide counter-balanced military pistol designed to replace the aging Browning automatic. Using composite plastics and ceramics, the Enfield factory has managed to produce a smartchipped high-capacity 12mm pistol of unrivalled accuracy for its class. The SAS and SBS versions of this pistol have been further modified to allow "double-tapping" of a target (ROF 2). [Rough Guide UK]

# LIGHT SMGS

Unless otherwise noted, all weapons use caseless ammunition.

### Federated Arms Tech-Assault: 160eb

SMG +1 J E 1D6 (.22) 30 10/30 UR 100M

Thirty-shot SMG with full-auto capacity. May melt under full autofire (10%). [Solo of Fortune]

### Federated Arms Tech-Assault II: 400eb

SMG +1 J C 1D6+1 (6MM) 50 25 ST 150M

An updated version of the venerable Tech Assault I, features larger clip, better autofire, no melting. Honest. [Cyberpunk 2020]

### Heckler & Koch MPK-9: 520eb

SMG +1 J C 2D6+1 (9MM) 35 25 ST 150M

A light composite submachinegun with high quality sights. Used by many Eurosolos. The industry mainstay. [Cyberpunk 2020]



**Militech Mini-Gat Machine Carbine: 695eb**

SMG 0 L P 1D6 (.22/5MM) 120 40 ST 150M

The .22cal caseless (5mm) has never been taken seriously as a defensive round until now. The Mini-Gat is a 5mm five barrel gatling gun capable of emptying its helical magazine in under five seconds flat! Don't be satisfied with some machine pistol's dinky thirty-round clip when a Mini-Gat carries one hundred and twenty rounds! It's electronically fired, operating from a rechargeable battery in the magazine. [*Chromebook 1*]

**Setsuko-Arasaka "PMS" Sub-Machine Gun: 950eb; 1150eb smartchipped**

SMG +1 L P 1D6+2 (7MM) 40 20 ST 150M

Setsuko-Arasaka (a division of the parent company) now produces their Police/Military/Security SMG in the United States at their new, automated Night City plant. Designed for low-profile corporate security and paramilitary forces where discretion is valued over raw firepower, the weapon fires a subsonic, caseless 7mm bullet paired with a built-in Sonex suppressor. Early models of this weapon gained the reputation of being fussy about ammo, and rumors surfaced that the weapon interface caused peripheral vision hallucinations. These problems were due to subcontractors substituting inferior or non-spec parts. The new PMS has been put through exhaustive testing to overcome all earlier problems. [*Chromebook 1*]

**Suranam Machine Pistol: 375eb**

SMG +0 J/L C 1D6+4 (.177) 25/50 50 UR 150M

This Korean-made "minisub," or mini-submachinegun fires the .177-caliber explosive caseless cartridge. It is made of carbon plastics, has a folding wire stock, and due to the small ammo size, the magazine can hold a very large number of rounds. Thanks to a small explosive charge which causes high bullet expansion, the ammunition is efficient, but the weapon's high rate of fire often causes severe overheating problems. The Suranam is a common choice for cyberarm weapon installation. Warning: If weapon jams/fumbles, there is a 75% chance it will cook off all the rounds in the weapon, causing 2D6 damage to the firer's arm; armor is halved. [*Solo of Fortune 2*]

**Uzi Miniauto 9: 475eb**

SMG +1 J E 2D6+1 (9MM) 30 35 VR 150M

Uzi's entry into the 21st century, all plastic, with a rotary electric clip and adjustable trigger. The choice for many security Solos. [*Cyberpunk 2020*]

# MEDIUM SMGS

**Unless otherwise noted, all weapons use caseless ammunition.**

**Arasaka WMA "Minami 10": 500eb**

SMG 0 J E 2D6+3 (10MM) 40 20 VR 200M

The standard Arasaka Security weapon, found worldwide. A good all-around weapon. For 200eb more, it comes in an integrally silenced model: Acc: -1, Conceal: L. [*Cyberpunk 2020, Corpbook 1*]

**Beretta 1010 Machine Pistol: 475eb**

SMG -2 J C 2D6+3 (10MM) 30 15 ST 100M

This model is a highly compact machine pistol designed for undercover security work and protection duties. In its basic form, the Beretta is somewhat inaccurate, but with the addition of either a laser or smart-rig it becomes ideal for its chosen role. Compact and thin, it produces no unsightly bulge in your designer suit when you're out escorting your employer. For further compactness a smaller magazine can be fitted (15 rounds) and the barrel shroud removed. This has the effect of lowering concealability to a large pocket: rating P (how large a pocket, the referee can decide). [*Rough Guide UK*]

**Beretta M-24 Advanced Submachine Gun:****950eb; 1250eb smartchipped**

SMG +2 L P 2D6+1 (9MM) 50 25 VR 200M

The new standard-issue SMG for Interpol. Beretta Euroarms has set new standards in weapon technology with their M-24 sub-machine gun. Using the time-proven M-12 SMG as the basis for this new weapon, they incorporate features such as an integral smart link, large magazine capacity, and a recoil compensator. The latest version, new for 2020, is the PM-24S. [*Chromebook 1*]





**Heckler & Koch MP-2013: 450eb**

SMG	+1	J	C	2D6+3 (10MM)	35	32	ST	200M
-----	----	---	---	--------------	----	----	----	------

Heckler & Koch's updating of the MP-5K classic, with compound plastics and integral silencing. [Cyberpunk 2020]

**IMI "Gamdaii": 950eb**

SMG	+2	N	E	2D6+3 (10MM)	35x2	25	VR	200M
HVY	0	-	-	(25MM/10GA)	1	1	ST	100M

A dual-feed 10mm caseless SMG mated to a single-shot 25mm grenade launcher. Intended to supplant current assault weapons for Mossad units, this weapon system is of high quality and fine machining. The gun feeds from twin magazines, allowing different types of ammo to be loaded. Ammo selection is via thumb-operated lever. Like most IMI weapons, the Gamdaii is easily modified for left or right-handed use. The grenade launcher's barrel is much shorter than most 25mm grenade launchers; special rimmed-case, low-velocity rounds must be used (these grenades cost 50% more than normal shells, but can be bought in the same varieties as standard 25mm mini-grenades). The grenades have a range of 100m, and it is impossible to load normal 25mm mini-grenades into the Gamdaii's grenade launcher. 10-Gauge shells can also be loaded when using a special sleeve. Safety note: IMI's special grenades do not have a safety distance! Once primed by firing, they will detonate as soon as they hit an object. Stand back! [Solo of Fortune 2]

**Malorian Arms Sub-Flechette Gun: 795eb**

SMG	+2	J	C	1D6x1D6	10/30	3/35	VR	200M
-----	----	---	---	---------	-------	------	----	------

Malorian Arms has beaten the competition to the punch with their new flechette submachinegun, a semi-bullpup configured weapon using a rotary bolt system similar to the proven M-95/G-11 operating system. This weapon uses the new 10mm caseless flechette round containing six steel penetrators capable of defeating any ballistic cloth body armor in present use. (Roll 1D6 to determine number of penetrators that hit per round. Each penetrator does 1D6 damage; armor x1/4. All penetrators from a single round hit in the same Body Area.) Equipped from the factory with three-round burst/full-auto capability, and an integral compensator. Ammunition magazines come in ten- and thirty-round capacities. [Chromebook 1]

**Militech 10 Submachine Gun: 455eb**

SMG	+1	J	E	2D6+3 (10MM) OR 2D6+2 (.45 ACP)	30	20	ST	200M
-----	----	---	---	---------------------------------	----	----	----	------

The Militech Ten uses composite plastics and the most modern computer machining techniques to create a submachine gun that is light, accurate, and a pleasure to shoot. Available in two calibers: 10mm PlasticCase and the venerable .45 ACP. Factory accessories include sound suppressor, scope mounts, grenade launcher and interchangeable caliber kits allowing a wide choice of firepower. And Militech doesn't forget the fashion conscious, with a choice of eight designer colors (red, blue, green, black, silver, camo, gold, gray). Note: Uses cased ammo. [Chromebook 1]

**Militech Viper Submachinegun: 600eb**

SMG	0	J	P	2D6+3 (10MM)	40	30	VR	200M
-----	---	---	---	--------------	----	----	----	------

The standard issue submachinegun for Lazarus troops. Typically used by airborne noncoms and by special ops troops who need a powerful, silenceable weapon. The silencer is an extra 150eb, and subtracts 1 from Acc. When the silencer is used firing is still audible, but the sound is greatly reduced and carries less. Submachineguns are rare in military service. Their high firepower is matched by low range; an assault rifle does as well, at better ranges. The Viper is a weapon seemingly designed for special operations units, and is usually found in said units, where it is rarely seen without its optional silencer. [Corpbok 2, Home/Brave]

**Mustang Arms ARS-5C Submachinegun: 600eb; 1200eb smartchipped**

SMG	+1	J	C	2D6+3 (10MM)	40	3/40	VR	100M
-----	----	---	---	--------------	----	------	----	------

MA's current model submachinegun. Like the Enforcement 10, it is fashioned mostly from the advanced ceramic Sortex™, and is available in matte black, blued, marine stainless and camouflage finishes. It is a new system for the young company, gaining popularity among law enforcement agencies and corporate armies. The ARS fires single shots, three-round bursts, and fully automatically at a punishing rate. The ARS is available with full and collapsible stocks, and with a variety of accessories including detachable scopes (+2 to single shots, only when aiming), laser designators (+1), and silencers (Awareness roll to hear). 650eb camouflaged, +100eb for scope, +100eb for laser designator, +50eb for silencer. [Corpbok 3]

**"Sten": 200eb approx.**

SMG	-2	L	E	VARIES	30	3/30	ST/UR	50-100M
-----	----	---	---	--------	----	------	-------	---------

This is a generic Nomad term for any homemade/modified submachine gun, in honor of the original Sten gun. The stats given are for a typical example, but they range from very reliable to almost-certain-to-blow-off-a-shooter's-hands. They are available in several different configurations, and may be chambered for any ammunition from .22 Long Rifle (1D6), through 9mm Parabellum (2D6+1), to .357 Magnum (2D6+3) and 12mm Caseless (4D6+1). Stens are also known in streetpunk culture as zipper-guns. [NeoTribes]



**Stolbovoy StS Submachinegun: 600eb; 1200eb smartchipped**

SMG	-1	J	C/R	2D6+3 (10MM)	35	30	VR	100M
-----	----	---	-----	--------------	----	----	----	------

The last item in Stolbovoy's line of basic weapons, the StS submachinegun also incorporates the company's unique designs, and is one of the finest submachineguns around. Available with collapsible or fixed stocks. Comes with iron sights, but can be fitted with a variety of aiming systems. Uses cased ammo. Note: On the FNFF reliability table, Stolbovoy weapons jam only on a roll of 1. Also, all Stolbovoy weapons are Common in the Soviet Union and Eastern Europe, and Rare in the U.S./Great Britain. [Corpbook 3]

# HEAVY SMGS

Unless otherwise noted, all weapons use caseless ammunition.

**CCMMC Tuzi-7: 500YY (125eb)**

SMG	-2	J	P	3D6 (11MM)	30	15	ST	100M
-----	----	---	---	------------	----	----	----	------

The heavy submachine gun used by the army (and favored by cheap hoods) for fighting in confined spaces. Semi-auto/full auto switch standard. Available only in China. [Pacific Rim]

**Chadran Arms City Reaper: 950eb**

SMG	0	L	P	3D6 (11MM)	40	20	VR	200M
SHT	-1	-	-	4D6 (12GA)	10	3	ST	50M

A dual-barrel, over-under weapon system carried by urban-deployed IPC troops. [Interface Issue 3, Vol. 1]

**Heckler & Koch MPK-11: 700eb**

SMG	0	L	C	4D6+1 (12MM)	30	20	ST	200M
-----	---	---	---	--------------	----	----	----	------

Possibly the most used Solo's gun in existence, the MPK-11 can be modified into three different designs, including a bullpup configuration, standard SMG, an assault carbine, and it will accept a grenade launcher mount. [Cyberpunk 2020]

**Heckler & Koch MPK-2020 SMG: 750eb**

SMG	+2*	L	P	4D6+1(12MM)	60	30	ST	200M	(*LASER SIGHT)
-----	-----	---	---	-------------	----	----	----	------	----------------

The Heckler & Koch Maschinenpistole-Kurz (MPK) 2020 is a descendant of the MP5 and the G3 assault rifle. About five years ago, special forces units in Europe were looking for a replacement for their main short-range assault weapons. After detailed discussion with such units as GSG-9, the SAS, GIGN and Corporate strike teams like Dieter Kaufmann's Taktischekampf Einheit O, H&K produced a caseless 12mm laser- or smartchipped assault carbine. Slightly longer than the MP5, the MPK 2020 is compact enough to be carried in a thigh or long shoulder holster. Its 60-round magazine is deemed large enough for an initial attack without having to worry about reloading. Uncommon outside of Europe, this weapon is now a mainstay of anti-terrorist and special forces units in the EuroTheater. [Rough Guide UK]

**Ingram MAC 14: 650eb**

SMG	-2	L	E	4D6+1 (12MM)	40	10	ST	200M
-----	----	---	---	--------------	----	----	----	------

Updated MAC-10, with composite body and cylindrical-feeding magazine. [Cyberpunk 2020]

**Sternmeyer SMG-21: 500eb**

SMG	-1(0)	L	E	3D6 (11MM)	30	3/15	VR	200M
-----	-------	---	---	------------	----	------	----	------

Sternmeyer's best entry in the anti-terrorist category, with wide use on C-SWAT teams and PsychoSquads. A heavy duty SMG with a collapsible stock and rugged construction for use in adverse conditions. The standard issue SMG for IEC security guards and IEC Army noncoms. Capable of firing in single shot from a closed bolt for accuracy or in three-round burst or full auto from open bolt for firepower. Unlike other open bolt designs, such as the Minami, the Sternmeyer does not have a fixed firing pin. When fired single shot from closed bolt the WA rises to 0. The gun also has mountings for an optical sight for use in the single shot mode. A tough and versatile weapon at a good price. [Cyberpunk 2020, Corpbook 1]





# SHOTGUNS

Unless otherwise noted, all weapons use cased ammo.

## Arasaka WCAA "Rapid Assault Shot 12": 900eb

SHT -1 N C 4D6 (12GA/#00) 20 2/10 ST 50M

A high-powered auto-shotgun with lethal firepower. Used by Arasaka worldwide. Another good reason to avoid the Boys in Black. Also known as "the Poser Hoser." [*Cyberpunk 2020, Corpbook 1*]

## CCMMC Qi-15: 600YY (150eb)

SHT -2 N P 4D6 (12GA/#00) 15 2/10 ST 50M

The assault shotgun favored by the PLA and Public Security for quelling riots. Full-auto preferred. Available only to military police in China. [*Pacific Rim*]

## Constitution Arms Hurricane Assault Weapon: 1000eb

SHT 0 N P 4D6 (12GA/#00) 40 4/20 ST 70M

A 12-Gauge Magnum that utilizes a dual reciprocating barrel action to minimize heat problems. Equipped with a forty-round saddle drum magazine, plus hydro-shock recoil compensation (mounted in the stock) that enables accurate autofire. Designed initially for urban police units requiring an extreme-force weapon against street violence and crowd control. However, the use of this weapon has come to the attention of many Max-Tac units, who see the smartchipped version as a perfect anti-cyberpsycho system. [*Protect & Serve*]

## Enfield-Ubichi LastChance: 60eb

SHT 0 J C 4D6 (12GA/#00) 1 1 UR 25M

A dangerous and depressingly popular variation on the polymer one-shot: a fiberglass tube, 45cm long, containing little more than a shell and a spring-loaded firing mechanism. Beloved of all sorts of hoodlums, lowlifes and hitmen. [*Eurosource*]

## Luigi Franchi P.16: 980eb

SHT +1 L R 4D6 (12GA/#00) 20 2/10 ST 50M

A short and stubby autoshotgun, generally used for security work and marketed as a "restraint rifle" since it can also fire incapacitating baton rounds and gas shells. Eurotheater police only. [*Eurosource*]

## Luigi Franchi "King Buck" Multi-Magnum: 800eb

SHT -1 N P 6D6/5D6/4D6 (10GA/#00) 4 2/4 VR 50M

The Italian-made King Buck is a four-barreled pepperbox-style shotgun, made for hunting big game. It has four separate barrels and chambers, and they can be fired one at a time, or (if you want to be really gross) you can fire all four at once! (You must have a cyberarm or a BOD of 11+ to do this, or suffer 2D6 to the Torso.) This magnum shotgun fires 10-Gauge 3" Magnum shells, and can load buckshot and slugs (and although it was not designed for this, it can also fire Militech Mini-Grenades). A huge, unusual and exceptionally heavy weapon (7 kilos), which is considered a collector's item. Note: Damages are at PB/Close, Medium, and Long. [*Chromebook 2*]

## MetaCorp Warhammer™ Assault Shotgun: 700eb

SHT -1 N P VARIES(12GA MAG) 16 1/3 VR 75M

Pancor was a small company built on one excellent product: the Pancor Jackhammer. The Jackhammer was a revolutionary weapon in many ways—advanced materials technology, rotary action, and barrel stabilization were just some of its features. Unfortunately, the military was not interested. When the Collapse came, Pancor was one of the companies destroyed by it. The weapon (except for a few hundred owned by police, special-ops units, and survivalists) disappeared. When Meta Corporation was formed in 2012, one of the techs from Pancor (who had been deployed to SouthAm with other Meta personnel) reapplied for a patent. The patent was approved, and the Warhammer, an improved version of the Jackhammer, was released in 2016. The Warhammer sports a larger mag capacity, more efficient cerametal barrel, and optional smartchipping. These improvements are complemented by a wide range of ammunition types, giving the weapon impressive tactical versatility. Common rounds include #00 Buckshot (4D6+3 magnum damage), an HE round (4D6/0.5m radius per shell), and a Dual-Purpose penetrator slug (4D6+2AP, damage vs. armor is x1/2; damage vs. unarmored is x1.5). Rounds cost 1/2/3eb per shell, and can be reloaded in the field. [*NeoTribes*]



**Military M-12 Close Assault Weapon: 950eb**

SHT 0 N P VARIES (12GA MAG) 20 3/10 VR 50M

"Close Assault Weapon" is a military euphemism for shotgun. Formerly outlawed by the now-extinct Geneva Convention, combat shotguns are common sights in 2020. The M-12 is a development of the first combat automatic shotgun, the Olin/H&K CAWS of last century. Its differences include a larger, rotary cassette magazine and a new selector switch (the firer can choose which kind of round he wants to shoot, but this reduces the shotgun's ROF to 1 for that round; otherwise he gets his rounds in predetermined order). Due to the great variety of rounds being used in combat shotguns and the M-12's selector switch, the old epithet "Dial-A-Gun" has been resurrected and applied to the M-12, so a soldier armed with an M-12 is a "Dally-Gunner." [*Home/Brave*]

**Militech Bulldog Compact Assault Shotgun: 1000eb**

SHT 0 L P VARIES (12GA.) 21 3/10 ST 50M

Selective-fire weapon utilizing a twenty-one round banana magazine. It was designed to fill the void left by the lack of easily controllable auto-shotguns, and uses a proprietary system of gas porting and spring compensation to reduce recoil. It also has an integral laser-diffraction scanner which draws a circle of bright red light equivalent to the pattern size at the impact point. For slug use, the laser may be tightened down to a narrow beam (+1 WA). The beam is also adjustable for different loads and barrel chokes. The gun fires single shots, three-round bursts, or full-automatic. It may be bought with a factory smartgun rig for 500eb extra. Load options available include basic #00 Buck (4D6), a jacketed twelve-gauge slug for armor piercing (4D6+2AP) and a twelve-gauge HE load (2D6, 2m diameter explosion area). When the HE shell is fired roll 1D10: On a 1-2, the grenade doesn't detonate; it will still do 1D6 if it hits a target directly. This weapon is common among Solos, Corp security troops, and paratroops expecting to do urban combat. [*Corpbook 2*]

**Militech Crusher 55G: 450eb**

SHT -1/-3 J C 3D6/1D6+2 (20GA./#4) 6 2 ST 12/25M

This pistol-sized shotgun was developed during the second Central American Conflict for close combat and roomsweeping duties. The Crusher is a handy weapon in 20ga. With its box-type magazine and 25cm barrel, but not very accurate. Notes: Due to "whippet" styling—stockless and short barreled, the weapon is -1 to 12m, -3 to 25m, and ineffective beyond that. The damages correspond to the two ranges. [*Chromebook 1*]

**Militech Military/Police Shotgun: 300eb**

SHT 0/-1 N/L C 4D6 (12GA./#00) 8 2 ST 50M

A gas-operated, semi-auto shotgun with an eight-round detachable box magazine and folding stock. A hard-working weapon for the hard-working corporate MP. May be ordered in either twelve or ten gauge (six-round capacity, no folding stock). Note: 10 gauge ammo does 5D6 damage. Second Acc. and Conceal. ratings are for stock folded. [*Chromebook 1*]

**Mustang Arms Close-Control 20: 350eb**

SHT -1 N P 3D6 (20GA./#4) 15 2 ST 50M

This utilitarian shotgun comes from the Night City-based firm Mustang Arms. Composed of lightweight composite materials, the C-C 20 is designed as a reliable antipersonnel weapon which won't devastate an enclosed area. The Close-Control 20 is a semi-auto 20-Gauge bullpup, loading buckshot, slugs, anti-riot baton rounds, or flechette shells. Its clear plastic box magazine holds 15 rounds, and the entire weapon is only 66cm in length. [*Solo of Fortune 2*]

**Mustang Arms "Raider" Riot Shotgun: 400eb**

SHT 0 L/N C 4D6 (12GA./#00) 5/9 2 ST 50M

The Raider is a standard design semi-automatic 12-gauge shotgun. It feeds from a five-round tube magazine and operates on blowback. The barrel, receiver and magazine are steel; the stock and forearm are matte black Sortex. The Raider is not available in camo finishes, but it does come with an optional folding stock (-1WA), and in a stainless marine version. The Raider uses an old-fashioned tube magazine, but it does have one innovation: The magazine can load one shell at a time from the bottom of the receiver like a conventional shotgun, or the entire tube can be ditched and replaced in a matter of seconds. The tubes are somewhat awkward to carry, but they are valuable in a crisis. An advantage of the Raider is that the folding stock model can be concealed under a long coat (Conceal. L). Options include extra magazines; a four-round magazine extension (not usable with replaceable mags); interchangeable barrels with different lengths, chokes and sights; laser designators; and optical sights for use with slugs and special loads. 25eb per magazine, 50eb per barrel, 50eb for the extended magazine. [*Corpbook 3*]

**Stermeyer Stakeout 10: 450eb**

SHT -2 L R 4D6 (12GA./#00) 10 2 ST 50M

A light duty stakeout shotgun, used by city police departments and IEC security forces. [*Cyberpunk 2020, Corpbook 1*]

**Tsunami Arms "Ragnarok" Close Assault Weapon: 4500eb**

SHT 0 N R 6D6 (12GA./#00 EAE) 40 2/20 ST 70M

"Better than the Best" is the famous tag line of Tsunami Arms advertising. This ultimate meat-grinder is their latest contribution to the Edge. It uses special Electrothermal Ammo Enhancement, combined with a dual reciprocating-barrel action and hydro-shock recoil compensation (see Constitution Arms Hurricane). The batteries are set on the stock; up to five can be mounted. This has been designed for the 2021 SDF arms trials, but the Tokyo C-SWAT already has a couple. [*Pacific Rim*]





COLT-AMT MODEL 2000 (P16)



ARMALITE 44 (P16)

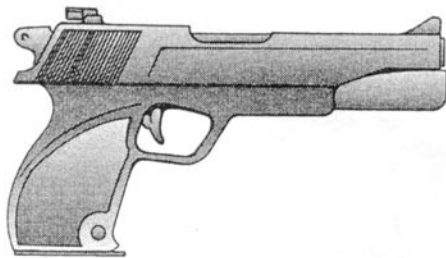

CONSTITUTION ARMS MULTIPLE AMMUNITION PISTOL (P16)

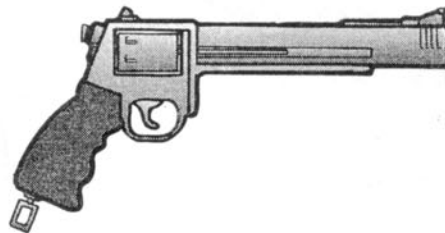

BERETTA 1010 (P18)

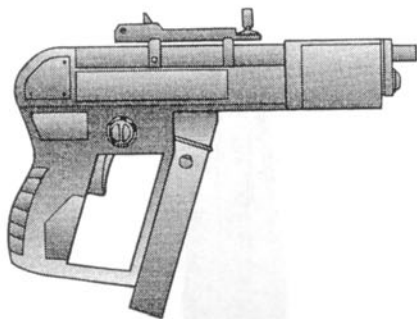

TSUNAMI ARMS  
TYPE-17  
AUTO-GL (P37)

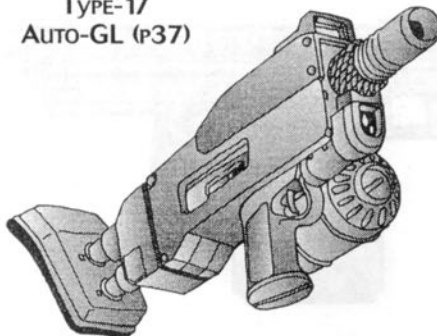

DYNATECH  
TASER (P6)

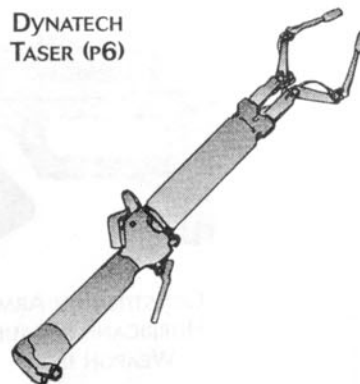

ARASAKA NAUSEATOR (P6)

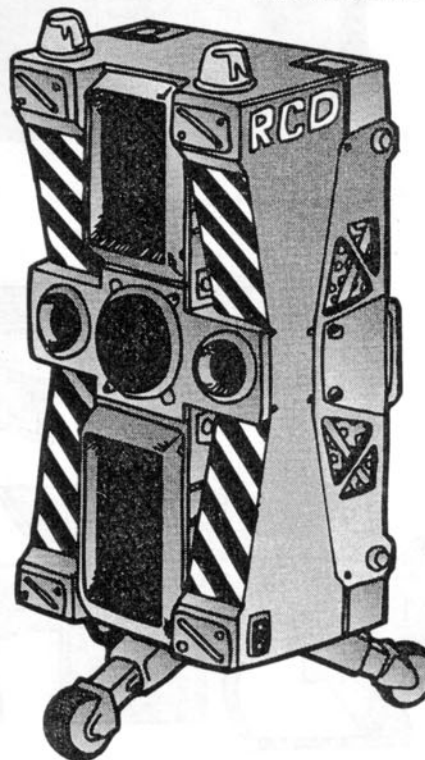

BERETTA  
PM24S (P18)

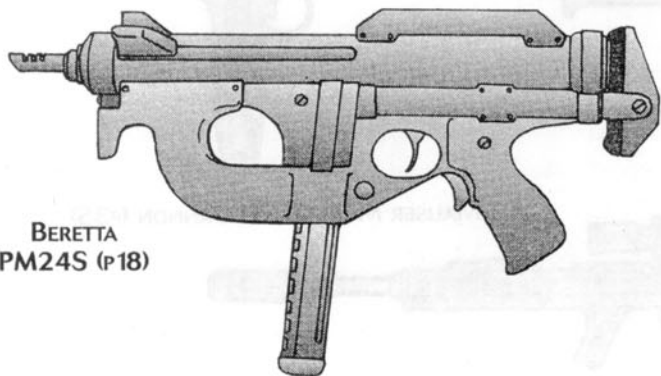

CHADRAN ARMS  
JUNGLE REAPER (P27)

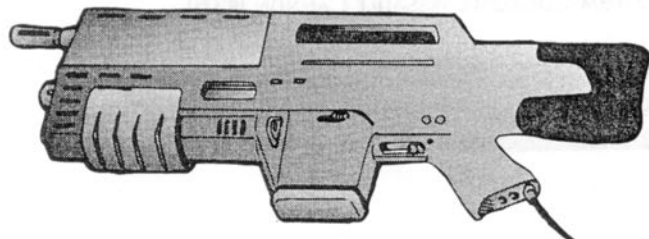

ILLUSTRATIONS NOT TO SCALE.



GONCZ-TAURUS PISTOL (P12)



ENFIELD "SPITFIRE" BATTLE PISTOL (P17)



TEXAS ARMS 351 GYROJET PISTOL (P13)



KENDACHI MONOKATANA (P3)



CONSTITUTION ARMS DELUGE CROWD CONTROL WEAPON (P33)



IMI CHAINKIFE (P2)



CONSTITUTION ARMS HURRICANE ASSAULT WEAPON (P21)

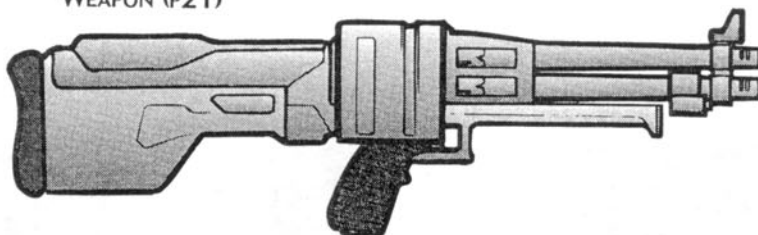

COLT-MALUSER M-2X 20MM CANNON (P35)

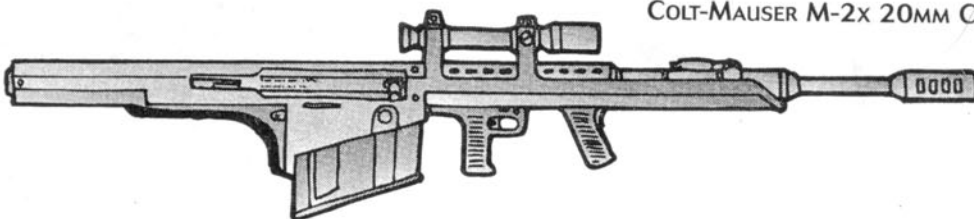

ENFIELD 25MM COCKERILL ASSAULT CANNON (P36)

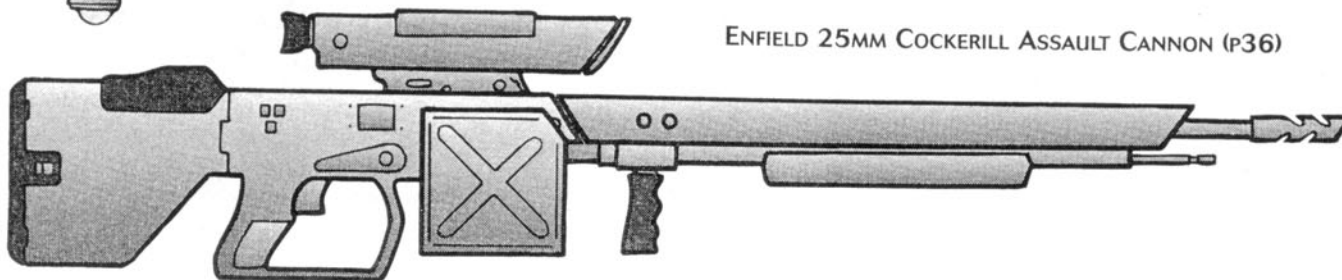

ILLUSTRATIONS NOT TO SCALE.





STEIN & WASSERMAN MODEL-F  
CYBORG ASSAULT (P32)

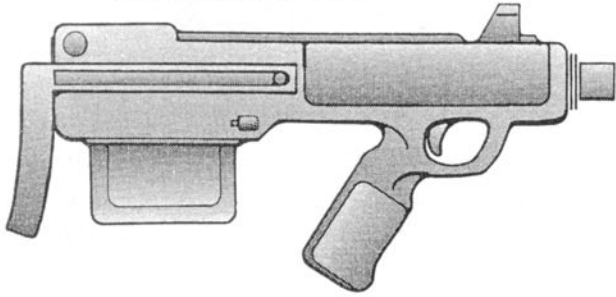

MILITECH SILVER SHADOW FLECHETTE PISTOL (P12)

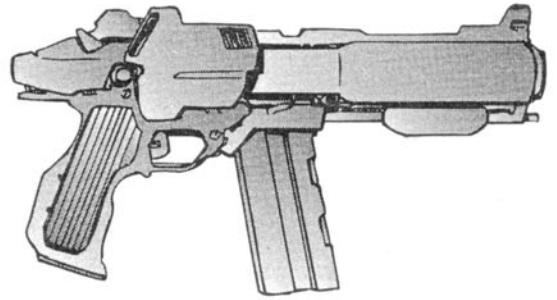

MAGNUM OPUS  
"HELLBRINGER" .666  
MAGNUM REVOLVER (P38)

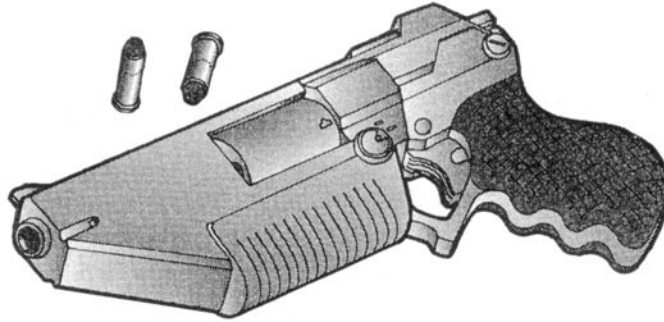

ENFIELD LPA1  
LIQUID PROPELLANT  
ASSAULT RIFLE (P29)

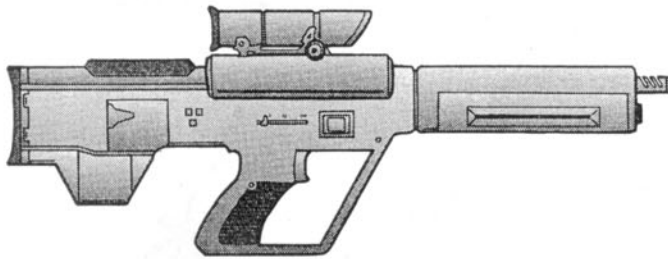

FEDERATED ARMS  
LA15 ASSAULT (P27)

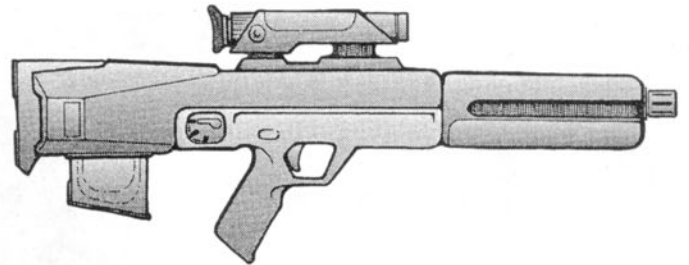

FN BROWNING "3-SPOT" (P11)

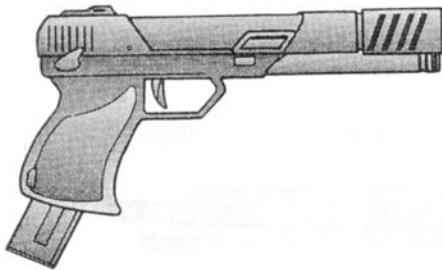

HECKLER & KOCH G-6K2  
ADVANCED SQUAD  
AUTOMATIC WEAPON (P33)



HECKLER & KOCH MPK-  
2020 (P20)

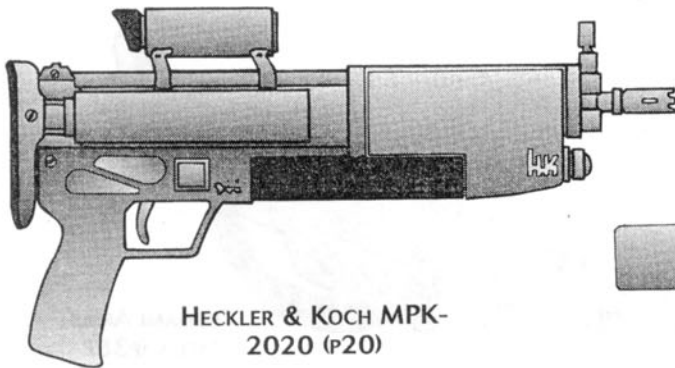

HECKLER & KOCH HK77UK ASSAULT CARBINE (P30)

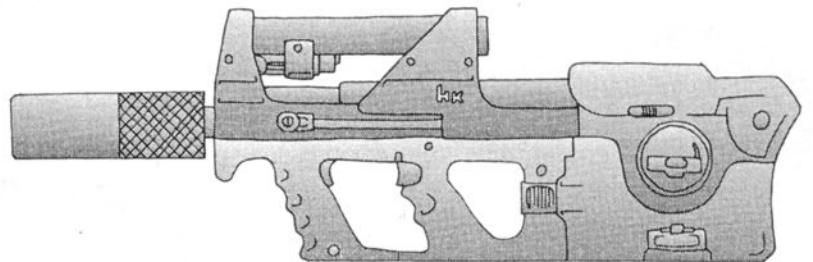

ILLUSTRATIONS NOT TO SCALE.



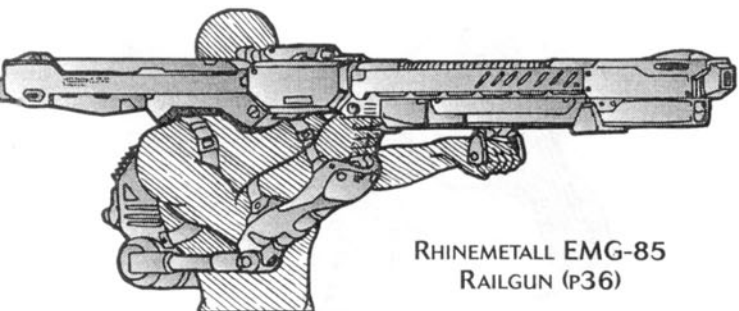

RHINEMETALL EMG-85  
RAILGUN (P36)

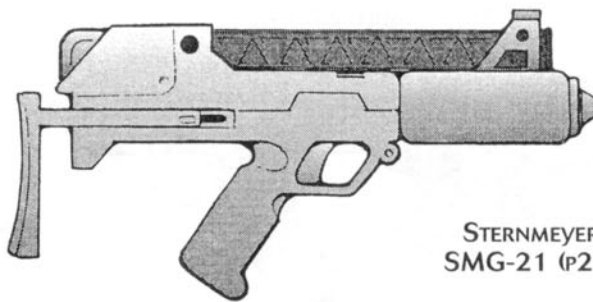

STERNMEYER  
SMG-21 (P20)

TECHRONICA M-40 PULSE RIFLE (P9)

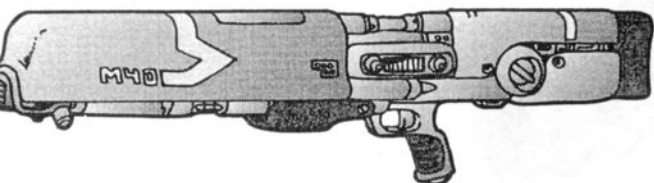

REMMINGTON  
GYRO-SNIPE (P30)

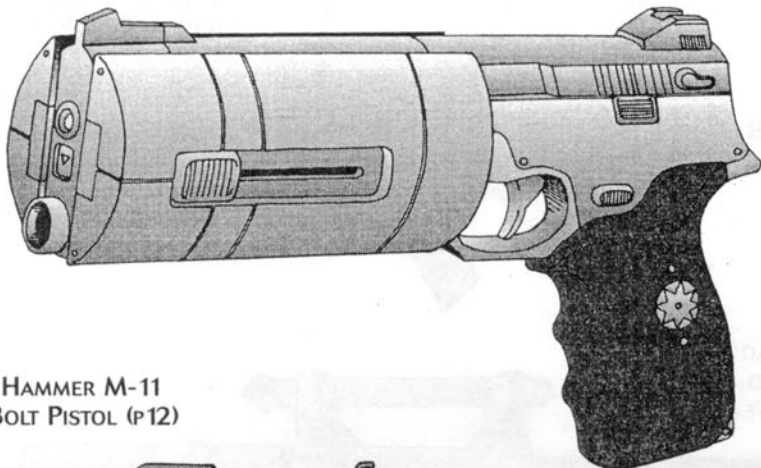
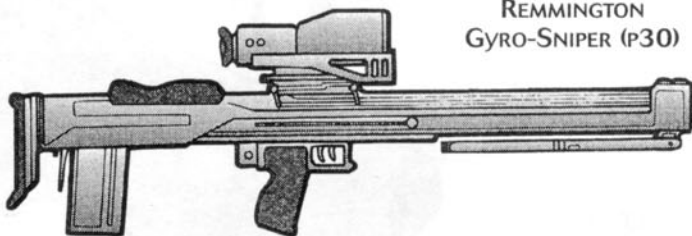

HAMMER M-11  
BOLT PISTOL (P12)

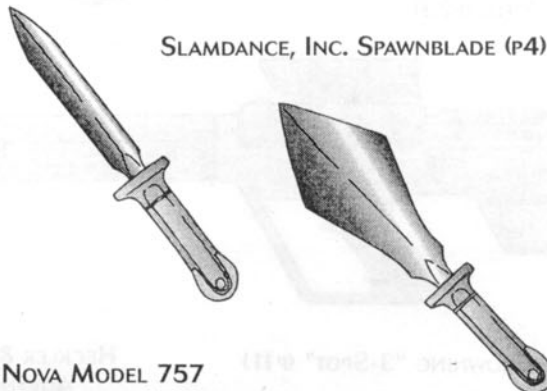

SLAMDANCE, INC. SPAWNBLADE (P4)

NOVA MODEL 757  
CITYHUNTER (P15)  
—THE NEW GUN—

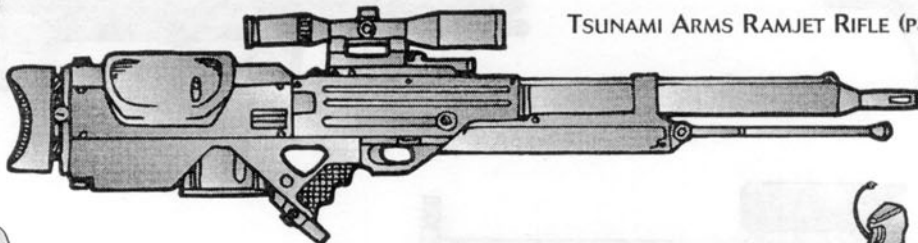
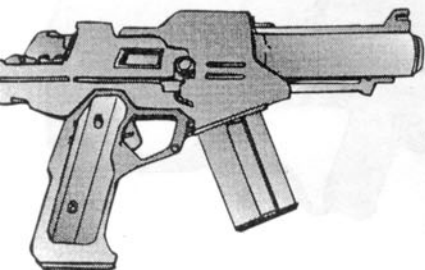

TSUNAMI ARMS RAMJET RIFLE (P32)

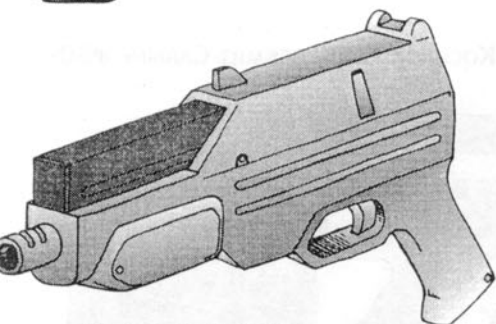

MALORIAN ARMS SUB-  
FLECHETTE GUN (P9)

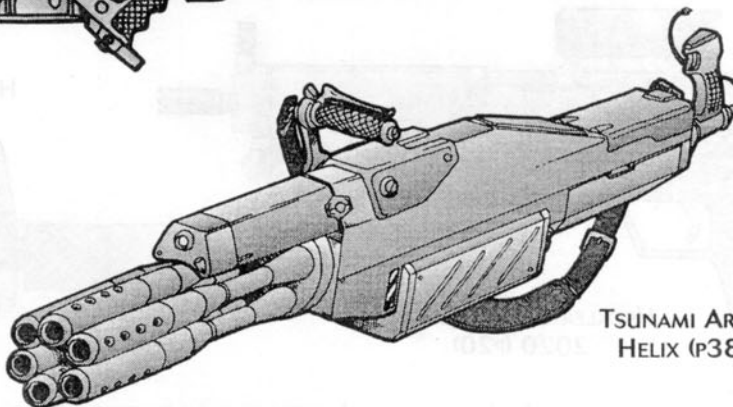

TSUNAMI ARMS  
HELIX (P38)

ILLUSTRATIONS NOT TO SCALE.





# ASSAULT RIFLES

Unless otherwise noted, all weapons use caseless ammo.

## AKR-20 Medium Assault: 500eb

RIF 0 N C 5D6 (5.45MM) 30 1/30 ST 400M

A plastic and carbon-fiber update of the AKM, distributed throughout the remains of the Soviet Bloc. Uses cased ammo. [Cyberpunk 2020]

## Arasaka WAA Bullpup Assault Weapon: 800eb

RIF +1 N C 5D6 (5.56MM) 15/30 3/30 VR 400M

A typical bullpup assault rifle. Like all Arasaka weapons, it is tough, reliable and comes chipped for smartgun use. It has an integral optical sight, and can take 5-, 15- or 30-round magazines. Standard issue weapon for Arasaka soldiers. [Corpbok 1]

## CCMMC Jinhua M-9: 500 YY (125eb)

RIF 0 N P 6D6+2 (7.62MM) 35 1/25 ST 400M

An assault rifle along the lines of the Militech Ronin M-20, but with bigger bullets and not as reliable. Identifiable by the gold flower on the stock, this is the standard rifle of the PLA. Available only in China. [Pacific Rim]

## Chadran Arms Jungle Reaper: 1,550eb

RIF +1 N P 5D6 (5.56MM) 60 20 VR 400M

HVY -2 - - VARIES (25MM) 6 2 ST 200M

A dual-barrel, over-under weapon system carried by IPC field troopers. [Interface Issue 3, Vol. 1]

## Colt M-18 Assault Weapon: 750eb

RIF +1 N C 5D6 (5.56MM) 35 3/30 VR 400M

The M-18 is Colt Firearms' latest full-sized assault weapon, and the third item in their new full-spectrum personal weapons line. Colt has been hurting since the U.S. Armed Forces abandoned the .45 Auto and the M-16 for Beretta, FN, and, later, Militech weapons systems. The new line is Colt's bid to regain its stature as a military weapons supplier, and the bulwark of this line is the M-18 rifle. The M-18 is a bullpup-configuration weapon chambered for the common 5.56mm round. It fires single shots, three-round bursts, and fully automatically. Like the other weapons in the line, the M-18 is fashioned from matte black Sortex. Camouflage finishes are available as well. The M-18 comes stock with a quick-acquisition optical sight (+1 to basic WA, only when aiming). This can be replaced with scopes and laser designators. 850eb camouflaged, +750eb smartchipped. [Corpbok 3]

## Darra-Polytechnic M-9 Assault Rifle: 300eb

RIF 0/-1 N/L P 4D6+2 (5.5MM) 40 2/25 ST 200M

The first assault rifle using a caseless cartridge built entirely in the Hindu-Chinese Confederation. Designed to use the 5.5mm caseless (Chinese), this weapon's lineage is clearly Kalashnikov. Ballistic qualities are similar to the early Soviet 5.45mm used in the AK-74 assault rifle. Two things are readily apparent when you first pick up this weapon. The first is the lack of interfacing for the shooter. This weapon is designed for military forces in the Third World who don't fit their soldiers with chips and plugs. Second is the old-fashioned configuration in an age where bullpups are the style. Side-folding stock and a 1.2x optical sight are standard options on the weapon. Because of the large numbers of these guns exported out of the Hong Kong trade zone, and their very low cost, the M-9 has become a common sight in the Third World and on the streets. Note: This gun normally uses special hollow-nosed ammo (armor SP x2; damage that penetrates is x1.5); standard ball ammo would do 4D6 damage. The hollow-nose ammo is 45eb per box of 100 rounds, and is only available in the Pacific Rim. [Chromebook 1]

## FN-RAL Heavy Assault Rifle: 600eb

RIF -1/-2 N/L C 6D6+2 (7.62MM) 30 3/30 VR 400M

The standard NATO/EC assault weapon for battlefield work. Bullpup design, collapsing stock. [Cyberpunk 2020]

## Federated Arms Light Assault 15: 400eb; 700eb smartchipped

RIF 0\* N C 5D6+3 (7MM) 30 3/25 VR 400M

Federated's bid for the plastic-frame, bullpup-configured, caseless market pioneered by H&K's G-11/12 and Sternmeyer's M-95A. As with all Federated products, this is a durable light rifle, with good accuracy and a low price. The LA-15 comes already rigged with





martgun interface plugs; the built-in optical sight is a welcome back-up when the weapon is used by non-chipped troops. With its durability, adaptable sighting systems, and inexpensive price tag, you can expect the LA-15 to give Darra Polytechnic's M-9 a run for the money in the Third World arena. \*Weapon is optimized for 3-rnd. burst; Acc. is +1 when firing in that mode. [Chromebook 1]

### Fábrica de Armes M-2012: 1400eb

IF +2 N P 5D6+3 (6.5MM) 30 1/4 VR 400M

Argentine assault rifle, based on bullpup designs of late 1990s. Good reliability, easily rechambered for other common round types. This weapon is chambered for a proprietary Argentine cartridge, the 6.5x45mm caseless, but is easily rebarreled for 6.2x39mm Soviet (5D6+3), 7.62mm NATO (6D6+2), or 7.5mm French Short (6D6+1). Adaptability may be a selling point for this rifle. Equipped with a Knopfler & König 2x laser reflex scope standard. [Solo of Fortune]

### Kalashnikov A-80 Heavy Assault Rifle: 550eb

IF -1 N E 6D6+2 (7.62MM) 35 3/25 ST 400M

Another Soviet retreat, with improved sighting and lightened construction via composites. [Cyberpunk 2020]

### Militech Dragon Light Assault Weapon: 700eb

IF 0 L C 6D6-1 (6.5MM HYBRID) 35 30 VR 400M

This is the standard Lazarus Group paratroop weapon, a light bullpup rifle chambered for the new 6.5mm round. It does not have a collapsing stock, but its compact design and light weight make it a practical weapon for airborne troops. The light weight of the hybrid 6.5mm cartridge means that paratroops can carry a goodly amount of ammunition on drops. It is designed to complement the Mk IV and uses many of the same parts, including the sight, magazines, bolt and bolt carrier. [Corpbook 2]

### Militech M-31a1 Advanced Infantry Combat Weapon: 1695eb

IF +2 N R 4D6 (4.5MM) 150 3/30 ST 400M

AGL -1 - - VARIES (25MM MINI-GREN.) 4 2 ST 150M

Two years ago, the Provisional United States government proposed a new competition to select an advanced infantry combat weapon. The armed services committee felt that the military had a fine weapon already, and decided to create an impossible set of design parameters to purposely set this weapon program back at least ten years. The first and only entrant in the competition was the M-31a1. Militech had developed a new grenade launcher firing a projectile the size of a 10-gauge shotgun shell, but with performance almost equal to standard 40mm grenades. Malorian Firearms had recently patented a new weapon system called "liquid propellant action", but didn't have the capital to develop anything beyond a working prototype. Eran Malour offered the license to Militech, and in just eighteen months, the M-31 AICW was in production. The M-31a1 is an over and under configuration with a 4.5mm caliber assault weapon atop a pump-action mini-grenade launcher. The liquid propellant action functions like an old-style gasoline motor in that propellant and oxidizer are mixed in a firing chamber, then electrically fired by pulling the trigger, launching a 4.5mm copper-jacketed bullet and cycling the action. The M-31a1 magazine holds 150 projectiles and the propellant necessary to fire them. Paired with the grenade launcher, this design has proven to be an efficient and deadly combination. The M-31A1 is not equipped to be outfitted with standard rifle accessories. [Chromebook 1]

### Militech Mk IV Assault Weapon (Revised): 800eb

IF +1 N C 6D6-1 (6.5MM HYBRID)/5D6 (5.56MM) 35 3/30 VR 400M

The Mk IV is a potent, heavy-duty, bullpup assault weapon only recently introduced to the Militech catalog. Its recoil compensation system and excellent design and balancing make it one of the most controllable weapons available. It has recently become the standard issue weapon for all Lazarus Group non-airborne infantry units. It is also the current standard issue rifle for U.S. infantry troops, complementing the Sternmeyer CG-13B (in service only with special units). The Mk IV is based off of the old Mk III design (hence Revised), and chambers the new hybrid 6.5mm round. The 6.5mm is a new concept that Militech is currently trying to market. It packs a wallop close to that of the heavy duty 7.62mm cartridge, while retaining a flat trajectory, controllability, and light cartridge weight reminiscent of the 5.56mm round. A big selling point of the Mk IV is that it comes with a quick change replacement barrel system that allows the weapon to be converted to 5.56mm under battlefield conditions. The Mk IV was designed to accept all U.S. military rifle accessories, including the M-205 grenade launcher. It can mount the Militech Mini-grenade launcher (pump version) under the barrel instead, if desired. [Corpbook 2]

### Militech Ronin Light Assault: 450eb

IF +1 N C 5D6 (5.56MM) 35 3/30 VR 400M

A light, all-purpose update, similar to the M-16B, the Ronin was the standard U.S. assault rifle for over two decades. Old-fashioned, with a serviceable bullpup design, firing caseless 5.56mm ammunition, it became a benchmark against which other assault rifles are measured. Like the M-16 before it, there were arguably better guns on the market, but the U.S. had thousands of them, and couldn't really afford to give them up and re-equip with new rifles until recently, when the Army and Marine Corps replaced it with the Mk IV Assault Weapon. Guard and reserve units are still largely outfitted with M-20s. The M-20 can be outfitted with the M-205 and other commercial grenade launchers. [Cyberpunk 2020, Corpbook 2]





**Royal Enfield Ordnance Liquid Propellant Assault Rifle LPA1: 1800eb**

RIF +1 N R VARIES (7.5MM) 2x45 1/3/20 VR 500M

The LPA1 is a twin-magazine, liquid-propellant, variable-velocity assault rifle. Designed as a multi-role small arms weapon system, it is now entering limited test service with the BCF. The LPA1 is laid out in the traditional bullpup configuration with the liquid propellant stored in a self-sealing armored cassette in the butt. The twin helical magazines are situated on either side of the receiver. Each magazine holds 45 rounds, giving the rifle an immense 90-round ammo supply. With dual magazines it is possible to carry mixed ammo types. The LPA1 can use most ammo options and can support rifle-fired grenades with a small muzzle modification. The rifle comes with three velocity settings, which can be selected either manually or by neural interface for smartchipped versions. The settings are 1) Low-riot/2D6+1, 2) Medium-urban/4D6, and 3) High-full combat/6D6. Because of the high recoil on full velocity, a hydro-pneumatic recoil damper was built into the rifle. The liquid propellant (a derivative of ESA shuttle fuel) is injected into the breech under computer control. The amount injected depends on the velocity setting and range of the target. This information comes from the integral Marconi SUSAT cyberoptic sight situated on top of the receiver. [Rough Guide UK]

**Sternmeyer M-95A4 (CG-13B) Assault Weapon: 695-750eb**

RIF +1 N R 5D6 (5.56MM) 90 3/30 VR 400M

Highly reliable, well-made plastic composite assault rifle. This is an advanced weapon firing a caseless 5.56mm round. It has seen limited service in special contingents of the U.S. Armed Forces and EC Defense Forces. IEC is the only corporation using this weapon in significant numbers. Refinements to the M-95A/CG-13A series for improved military applications and release as the A4/13B model include a tougher body, modular sight system, improved heat dispersal system and true magazines instead of the old disposable-box pour-in system. Magazines for the A4 resemble the old G-11 boxes, but instead of merely storing ammo, the entire box slides into the receiver over the barrel. It makes for a little more susceptibility to contamination from dirt, but it also makes reloading easier and quicker under combat situations. The magazines are high-impact plastic and disposable. The modular sight system allows quick changing from telescopic to powered optical to laser sights without tools. The basic rifle comes with a 4x optical sight. A telescopic sight and laser sight are available at 150eb each. [Solo of Fortune, Corpbook 1, Home/Brave]

**Stolbovoy St-5 Assault Rifle: 900eb; 1800eb smartchipped**

RIF -1 N C/R 5D6 (5.45MM) 30 1/30 VR 400M

A light, sturdy bullpup weapon, the St-5 was designed to withstand the rugged environmental conditions in the Soviet Union. Using innovative design and special lubricants, Stolbovoy has created a weapon that can operate reliably under the most adverse conditions, including heat, cold, mud, dampness, sand and grit, lubricant contamination, and corrosive environments. One of the toughest, most reliable assault rifles in the world; troops are quoted as saying, "It never breaks!" Comes with iron sights, but can be scoped. In long and short barreled versions. Uses cased ammo. Note: On the FNFF reliability table, all Stolbovoy weapons jam only on a roll of 1. Also, all Stolbovoy weapons are Common in the Soviet Union and Eastern Europe, and Rare in the U.S./Great Britain. [Corpbook 3]

**Towa Manufacturing Type-20 Advanced Infantry Combat Weapon: 4200eb**

RIF +2 N P 5D6 (5.56MM) 100 3/45 VR 400M

HVY 0 - - VARIES (25MM) 4 2 ST 150M

Latest assault rifle of the SDF. Smartgun system (raises WA to +4), pump-action 25x50mm Mini-Grenade launcher, and bipod (+1WA at Long/Ext range) standard features. [Pacific Rim]

**Towa Manufacturing Type-99 Assault Rifle: 1500Eb**

RIF +1 N P 5D6 (5.56MM) 35 3/30 ST 400M

The Type 99 has been the standard assault rifle for the Japanese SDF since 1999. Smartgun rig (raises WA to +3) and bipod (+1WA Long/Ext range) standard. [Pacific Rim]

# SNIPER RIFLES

Unless otherwise noted, all weapons use caseless ammo.

**Arasaka W55A Sniper System: 2400eb**

RIF +5\* N P 6D6 (3.5MM FF) 40 2 VR 600M \*SMARTCHIPPED

Designed for urban-deployed corporate enforcement teams, the heavy-barreled, semi-auto Arasaka W55A has a 40-round helical mag of sabotaged 3.5mm Frag-Flechtes (see Kendachi Frag Flechettes), and is equipped with a silencer, flash suppressor and a Zeiss 12x scope with computer-enhanced laser sighting. This system already includes smartchipping, and a whole lot more (+2 to Awareness, night vision, and rangefinding). With a loaded weight of 3.8kg, this is becoming a very popular sniper weapon. [Solo of Fortune 2]



**Barrett M-90 Sniper Rifle: 1500eb**

RIF +3 R 6D10 (12.7MM BMG) 10 1 VR 1000M

One of the world's heaviest sniper rifles, this is a development of the old Barrett BMG rifle. It fires accurized .50 caliber rounds, and is useless without a scope. A cyberlinked version is available for 2,500eb. Uses cased ammo. [*Home/Brave*]

**Barrett-Arasaka Light-20: 2000eb**

RIF 0 N R 4D10 (20/9MM APFSDS) 10 1 VR 450M

The cyberpsycho hunter's favorite. Almost 2 meters long, this "cannon" fires a depleted uranium shell at supersonic speeds. Guaranteed to drop a metalhead at 50 meters. Long-range sniping weapon common to special ops teams. Also known as the Type-13 Heavy Sniper Rifle to the Japanese Police/SDF. Note: The heavy sub-caliber penetrator damages armor for 2SP per hit. [*Cyberpunk 2020, Corpbook 1*]

**FR-F6: 1100eb**

RIF +3 N P 6D6+2 (7.62MM) 10 2 ST 500M

A modern French sniper's rifle, with bipod (+1WA at Long/Ext range), computer-assisted laser scope and sound suppressor. [*Eurosource*]

**Nomad 15mm "Long Rifle": 3000eb**

RIF +1 N P 7D10 (15MM BMG) 9 1 ST 900M

Although the adoption of the 15mm BMG round (to replace the antique .50 cal) in the mid-1980s was never fully implemented (except in Europe), there were a number of weapons developed to jump on the 15mm bandwagon. The Collapse brought down most of these developers. A few years later, the Aldecaldos came across an old factory while salvaging back east. Hundreds of examples of 15mm BMG weapons had been tested or designed there, and all the tools and equipment were present to manufacture them—so the Aldecaldos did. Now most nomads use the 15mm BMG for anti-vehicle and sniping work. The media have taken to calling them Nomad Long Rifles, or even Kentucky Rifles. These weapons are huge and heavy, but when emplaced on a hill, they allow combat at a distance—something Nomads prefer. The most common version includes a scope mount with a 10x optical scope and LowLite, muzzle brake, flash hider, solenoid trigger, bipod and custom furniture, and can be disassembled into three component parts (stock, action, barrel). All these options are included in the price listed above. You must possess a BOD of 9+ to fire this weapon from a standing position. [*NeoTribes*]

**Remington Gyro-Sniper Rifle: 1000eb**

RIF +2 N P 7D6 API (18MM GYROJET) 6 1 ST 600M

A development of the gyro-rocket system initially proposed by Hughes and Militech in 2008, the Remington Gyro-Sniper fires a rocket-propelled, gyrostabilized shell. Through the use of advanced sensor technology, the shell homes in on the weapon's laser designator. The designator's integral range-finding computer determines such factors as wind speed/direction, distance to target, etc., then vectors the shell toward the intended target. LowLite and infrared capabilities are built in. The incredible stopping power (and long range) of the Gyro has earned it the nickname "Zeus' Lightning" among police and Max-Tac snipers. Its ammunition is quite expensive: 400eb for a case of 50 shells. Note: because a rocket shell takes time to reach full velocity, the weapon does 3d6+2 and is 0 Acc. at 75m or less. Armor-Piercing Incendiary (API) ammo does an extra 1d6 damage for 2 combat rounds after hitting. Armor does not stop this extra damage. [*Protect & Serve*]

**Towa Manufacturing Type-00-Kai: 3000eb**

RIF +3 N R 9D6+3AP (7.62MM EAE) 6 1 VR 1200M

Redesigned version of the Type 00 sniper rifle, used by Japan's SDF and Police SWAT since 2000. Uses cased ammo for Electrothermal Ammo Enhancement. Comes with smartchipping and computerized sights (add +3 to WA). [*Pacific Rim*]

## OTHER RIFLES

Unless otherwise noted, all weapons use caseless ammo.

**Heckler & Koch HK77UK: 750eb**

RIF +1 L P 2D6+4 (9MM LONG) 30 3/30 VR 250M

A new assault carbine in use by private military units worldwide. H&K's British subsidiary has installed the latest in collapsing stocks and auto-stabilizers, making it more accurate than most competitors. There's a wide range of attachments available: Millitech's 25mm Mini-GL, a full-spectrum electronic sight for use with SmartGoggles™ (+600eb), an integral suppressor system (+200eb), and an extended magazine (45-rnd U-drum; 60eb). Note: Suppressor reduces WA to 0, cannot be heard without cyberaudio (extended hearing range). Folding stock reduces Conceal from L to J, but firing while folded reduces WA to -1. [*Solo of Fortune 2*]



**Hughes Rocket Rifle: 750eb**

RIF -1 N R 3D10AP (18MM HEAT/GYROJET) 3 1 ST 500M

The Hughes rocket rifle is the military monster that motivated Remington to make their Gyro Sniper rifle. Where the Remington uses the space in its 18mm shell for extra fuel and guidance, the Hughes uses a shell almost twice the length for added warhead power. It is a lightweight alternative to the Barrett-Arasaka 20mm. While the Remington's API round is not a fully efficient armor-piercing round in game terms (the extra 1D6 damage merely affects through the armor), the Hughes rifle round uses a shaped charge and is truly armor-piercing. Like all other shaped-charge, D10 rounds, damage penetrating armor is not halved. Ammunition costs 20 eb per round. [*Home/Brave*]

**M-99 EVAW: 5000eb**

RIF +5 N R 6D6AP (12MM ROCKET) 30 2 ST 400M  
 HVY 0 - - 2D6+1 (25MM HE) 10 1 ST 10M MINIMUM RANGE, 2000M EFFECTIVE RANGE

The M-99 Extra-Vehicular-Activity Weapon is the signature weapon of the USAF EVATs, the astronaut troops of the U.S. Aerospace Force. The weapon is a cumbersome monstrosity with two barrels, two massive magazines, and a CO<sup>2</sup> booster tank strapped to the EVA Trooper's belt. It fires two kinds of self-propelled rounds, using the compressed gas to eject the rounds from the barrel before their rocket propulsion ignites. The first round is a 12mm seeking slug that homes in on infrared and radar sensors (it's quite expensive); in addition, there is an IFF reader in the shell to prevent it from tracking on friendly targets. The second round is a standard 25mm high explosive grenade fitted with a small rocket booster and a proximity fuse. Both rounds are equipped with an end-of-range self-destruct charge, which destroys the round when it goes beyond a set range (usually 10% beyond maximum range at velocity). The advantages of the EVAW are low recoil, no heat emission, low gas ejection (standard rounds produce a cloud of smoke in zero-g/zero-pressure atmosphere), practically no moving parts, and built-in accuracy. Admittedly, it's not as perfect a space weapon as a portable laser, but it's almost as good. Grenade rounds cost 50eb, rocket rounds cost 125eb. [*Home/Brave, Deep Space*]

**Militech Cyborg Rifle: 800eb**

RIF +1 N P 7D6+3 (.300MAG) 30 20 ST 500M

Made for 'borg fighting, the Cyborg Rifle can be relied on to drop a metalhead at any range. A massive bullpup weapon, designed around the old .300 Winchester Magnum hunting cartridge. Both standard and armor-piercing ammo is available—the latter capable of cutting through all known forms of Body Plating! The rifle is equipped with hydro-pneumatic recoil control, but most non-augmented soldiers will find its bulk taxing (7.5kg). [*Chromebook 2*]

**Militech Ninja: 650eb**

RIF +1 L C 1D6 (5MM/.22) 30 3/30 VR 250M

A highly reliable caseless design with few moving parts and an integral silencer. A plastic magazine and solenoid firing pin makes this assault carbine incredibly quiet. Perfect for black operations! In gray, camouflage or black finishes. [*Solo of Fortune*]

**Nomad .357 Magnum Automatic Carbine: 400eb**

RIF 0/+1 L C 2D6+3 (.357) 30 2/3 VR 100M

Based on the same concepts as the Uzi and AK-47, this is carried by Nomads who are expecting action and use their weapons a great deal. The weapon may either be fired single-shot or in three-round bursts. When fired single-shot (ROF 2) the accuracy is +1. This weapon is intentionally not capable of full automatic fire. The magazine is a standard box type. This cartridge is somewhat downloaded; standard hot loads do 3D6+1 damage. Uses cased ammo. [*NeoTribes*]

**Nomad .357 Magnum Lever-Action Carbine: 300eb**

RIF +2 L C 2D6+3 (.357) 9 2 VR 100M

Based on a 140-year-old Winchester design, this weapon is extremely accurate and well balanced, in part due to improved machining and materials technology. The magazine is a non-detachable tube under the barrel. Rounds must be loaded one at a time; reloading takes three rounds. This cartridge is somewhat downloaded; standard hot loads do 3D6+1 damage. Uses cased ammo. [*NeoTribes*]

**Nomad .44 Magnum Lever-Action Rifle: 650eb**

RIF +1 L C 4D6+2 (.44) 8 2 VR 200M

This is carried by those Nomads looking for a little more punch; Outriders favor it. It is similar in all respects, save caliber, to the .357mag version. Uses cased ammo. [*NeoTribes*]

**Nomad 7.62mm Bolt-Action Rifle: 500eb**

RIF +2 N C 6D6+2 (7.62MM) 6 1 VR 400M

A fourth or fifth-generation copy of original Winchester and Remington designs, this is a time-tested survivor of the 20th century, differing very little from its predecessors. These modern versions use weatherproof, long-wearing plastics and ceramics in their construction. Examples include the M-70 sniper rifles used by the U.S. Army and Marine Corps before the Collapse. Uses cased ammo. [*NeoTribes*]





**Domad "Personal Weapon" Derivatives: 500eb**

F/SMG +1 L P 3D6 (5.7MM) 50 2/3 VR 200M

Derivative of designs by FN and others (the P90, Steyr TMP, Bushman IDW), the original Personal Weapon was designed for vehicle crews and rear echelon personnel that did not have the need to carry a full-sized assault weapon. This is a collapsed-bullpup design, with the magazine 90° off the weapon axis along the top of the weapon. Most of the construction is nyllex-based material, only the receiver and barrel being alloys or cerametal. The current personal weapons usually fire 10mm caseless (2D6+3), 12mm caseless (4D6+1), or in older versions, 5.7mm (3D6) cased rounds. This weapon could be called either a heavy SMG or an assault rifle. [*NeoTribes*]

**Polymer One-Shot Cannon: 90eb**

F -2 L C 4D6+2 (13MM) 1 1 UR 100M

Heavy firepower in a disposable package! This plastic blaster from Kang Tao is the ultimate last-chance weapon—after all, you're not going to need more than one explosive 13mm bullet to get the toughest pursuer off your tail! To keep costs down, the "One-Shot Cannon" is made from inexpensive materials, and the shell is filled with stable explosive materials. Notes: The 13mm shell is a low-velocity HEP (High-Explosive Plastique, cratering) round which does 4D6+2: damage is 1/2 real, 1/2 stun only—armor has no effect and is damaged 2 levels. The gun is so poorly made that if it jams, it breaks—and there's a 10% chance the weapon explodes, doing 2D6 to the firer's arm! [*Chromebook 2*]

**Stein & Wasserman Model F "Cyborg Assault"**
**Weapon System: 1650eb**

F 0 L P VARIES (13MM) 8 1 VR 100M

The hot weapon for psycho-squads everywhere, the Cyborg Assault is the Rolls-Royce of close-in shoulder arms designed to top the heavily enhanced. This bullpup carbine fires a wide selection of rounds (see below) and is muzzle-adapted for DCR rifle grenades as well! The unique eight-shot box magazine with rotary feed can be loaded with all ammo types at once, and the selector switch allows the shooter to pick the load type by its number position in the magazine! Uses cased ammo. The following assortment of ammo is available: HEP (high-explosive cratering) 4D6+2; damage is 1/2 real, 1/2 stun-only; armor has no effect, and is damaged 2 lvls. API (AP incendiary) 4D6+3; armor SP is 1/2; 1st round after hit target takes 1D6 extra, 2nd round, 1/2D6 extra. Armor does not stop this extra damage! Acid Shell (glass-lined capsule) damage and effects equal to Nelspot Vombat," except duration is 4 combat rounds. [*Chromebook 1*]

**Sunami Arms Ramjet Rifle: 1,230eb**

F +4 N P VARIES (8.5MM RAMJET) 9 3 VR 800M

The top-secret Japanese weapons design firm once again lives up to its rep with the Ramjet Rifle, a remarkable new weapon which is well suited to the roles of sniper, counter-sniper and light anti-armor weapons system. What makes this rifle special is the bullet which it fires—not a normal slug, flechette or gyrojet, these 8.5mm projectiles are small ramjet engines! Fired from the rifle at a velocity of 3,200 feet per second, the supersonic bullets have a conical aperture in their nose into which the air is compressed. This jet of hot air ignites the fuel stored in the bullet which blasts out the back, accelerating the round. This results in a constant increase in the velocity and energy of the shell until it reaches its maximum range, making the Ramjet Rifle a harder hitter the further it is from its target. The gun is a semiautomatic, caseless ammo-firing bullpup made of lightweight polymers, boasting an adjustable grip and stock as well as an adjustable bipod and a free-floating heavy barrel. For superior accuracy at long ranges, the Ramjet Rifle comes equipped with a 4x telescopic laser-reflex smartgun interlock, which paints the target with a laser and then uses microprocessor-controlled liquid lenses to determine the range and the proper elevation to hit the target at that range by moving the aimpoint, causing the shooter to bring it to the correct angle. Note: 5D6+3 at Close range, 6D6+1 at Medium range, 7D6 at long range and 7D6+3 at Extreme range. Armor SP is x3, and penetrating damage is doubled since it is effectively a large hollow-point round. [*Chromebook 2*]

# MACHINEGUNS

Unless otherwise noted, all weapons use caseless ammunition.

**Constitution Arms Cyclone Squad Support Weapon: 1200eb**

HVY +1 N P 6D6+2 (7.62MM) 100 35 VR 500M

One of the few weapons specifically designed for the type of mission so frequently given to the likes of Max-Tac. The weapon is chambered for 7.62mm caseless ammunition and has a 100-round drum magazine to feed it. Carrying sling and bipod are stan-



dard. The high rate of fire and stopping power of the 7.62mm round makes the Cyclone effective against any human or semi-human target. Military sales have been disappointing to CA, but the potential of the Cyclone has been discovered by the police force, and so production will continue. *[Protect & Serve]*

**Constitution Arms Deluge Crowd Control Weapon: 800eb**

HVY 0 N P 1-2PTS+DRUG 400 35 ST 60M

The Deluge is essentially a machinegun that fires darts of ballistic polymer at an extreme rate of fire. Designed as a crowd-control weapon, it is capable of quelling a riot in a matter of minutes due to the sleep drug that each sliver is impregnated with. Because of this potentially non-lethal ability, the Deluge is most often seen mounted upon riot trucks and occasionally on other police vehicles. The magazine contains 400 sleep darts and a compressed air canister required to fire the weapon. A magazine sells for 125eb and they are only available in sleep dart format. *[Protect & Serve]*

**X Dover GA-1112 Autogun: 1110eb**

HVY +1 N R 4D6+4 (12MM LONG) 400 80 ST 400M

The GA-1112 is a "man-portable" MG chambered for 12mm Long Caseless ammunition. A double-barreled weapon, the GA-1112 feeds from an underside-mounted drum. Weighing about 15kg (empty), it comes with a sling for support; an integral smartgun rig compensates for the hip-firing position. This weapon must be squeeze-cocked to start the motor (one combat round), and then it can be fired. The ultimate man-portable area-suppression weapon for cyborgs! For an additional 650eb, you can get a vehicle-mounting kit: swivel-clamp mounting, 1200-round ammo tank, and direct-from-motor power feed. *[Solo of Fortune 2]*

**FN MG-6 "One-on-One": 1800eb**

HVY +1 N P 5D6 (5.56MM) 100 40 VR 450M

Twin-barrel Belgian military machinegun, sold all over the world and still a standard by which such weapons are measured. *[Eurosource]*

**Fábrica de Armas M-2012HB SAW: 1600eb**

HVY +2 N P 5D6+3 (6.5MM) 100 30 VR 450M

A squad automatic version of the well-known 6.5x45mm caseless Argentine rifle. The weapon comes with a 100-round ammo drum and a 31-inch ceramic-clad heavy barrel. The K & K 2x laser reflex scope remains standard. *[Solo of Fortune]*

**Heckler & Koch G-6 Advanced Squad Automatic: 2050eb**

HVY +1 N P 5D6 (6MM) 100 30 VR 450M

In 2018, H&K decided to build a squad heavy weapon based upon the G-11/12 rotating bolt system. By scaling up the basic G-11 rifle by 50%, the desired weapon completed initial testing and was designated the G-6 Squad Automatic Weapon. The caseless 6mm round is accurate out to 900 meters, and the 100 grain bullet has a steel core to defeat body armor (standard AP). A gunner normally carries eight 100-round magazines. This light machinegun has full interface for the chipped soldier and an integral 2x scope with cyberoptic triangulation and passive IR capability. The latest version, for 2020, is the G-6K2. *[Chromebook 1]*

**M2A5HB Browning .50cal HMG: 2000eb**

HVY 0 N P 6D10 (12.7MM) 100 10 VR 600M

The immortal Browning .50 caliber machinegun still rules the battlefield of heavy machineguns, with its relatively light ammunition mass, proven reliability, massive hitting power, and the huge ammo supply still in stock. The A5 model is lighter than its predecessors, built with plasti-cerimets and composites rather than the old-fashioned steel used in previous models—it only weighs 20 kilograms, a real improvement over the 36+ kg of former makes. With a power exo-mount, a normal soldier can carry and fire an M2 on the move. *[Home/Brave]*

**M-60D Medium Machine Gun: 1000eb**

HVY +1 N P 6D6+2 (7.62MM) 100 20 VR 500M

The venerable M-60 soldiers on, its original German feed mechanism (lifted from the MG-42) still intact. It is the standard medium machinegun of the U.S. military, and is virtually identical to Germany's new medium MG; certain internal parts of both guns are interchangeable. The M-60D uses 100-round belts of plastic-cased 7.62mm ammunition. This has only two-thirds the cost of metal-cased ammo. The plastic casings are made of a heat-absorbing and -resistant material which acts as a thermal sink, keeping the air-cooled machinegun from overheating. Uses cased ammo. *[Home/Brave]*

**Militech High Power 15: 1600eb**

RIF/HVY +2 N P 2D6+4 (9MM LONG) 180 20/60 ST 200M

A three-chambered, tri-barrelled, high-speed autogun for personal use! This alley sweeper has a firing rate of nearly 5,000 rounds per minute (cyclic), feeding from a fixed ammo drum or belt-linked 400-round hip pack. *[Solo of Fortune]*



**Militech M-232 Squad Assault/Automatic Weapon: 1000eb**

IF/HVY	+0	N	P	5D6 (5.56MM)	100/35	20	VR	400M
--------	----	---	---	--------------	--------	----	----	------

The M-232 is an early development of the Militech Renegade SAW. A fairly standard light-caliber machinegun, the M-232 is the most common squad support weapon in the U.S. Army. The Marine Corps prefers to use either the M-12 CAW or the M-60D medium machinegun. The M-232 uses either belted rounds fed from a drum or a standard Mk IV clip. It comes with integral bipod, and cannot be fitted with standard rifle accessories.. [*Home/Brave*]

**Militech Renegade Squad Automatic Weapon: 1100eb**

VY	0	N	R	6D6-1 (6.5MM HYBRID)	200/35	20	ST	400M
----	---	---	---	----------------------	--------	----	----	------

The SAW commonly used by Lazarus troops. A light and effective weapon, firing 6.5mm Hybrid caseless ammo, and capable of taking disintegrating belt ammunition or clips from the Dragon or Mk IV assault weapons. [*Corpbook 2*]

**Militech 20L Autocannon: 3000eb**

VY	0	N	R	8D10 (20MM)	100	10	VR	500M
----	---	---	---	-------------	-----	----	----	------

The Militech 20L is a tripod-mounted lightweight 20mm autocannon. It is exclusively a crew-served support weapon, because its size and ammunition weight require a vehicle for transport. A single belt of ammunition weighs 20 kg! Uses cased ammo. [*Home/Brave*]

**Sternmeyer M-5A Squad Automatic Weapon: 1000eb**

VY	-1	N	R	6D6+2 (7.62MM)	200	20	ST	500M
----	----	---	---	----------------	-----	----	----	------

A fine one from Sternmeyer Waffenfabrik. The M-5A is a bipod-mounted, belt-fed 7.62mm weapon common to Arasaka and IEC soldiers. Can be vehicle-mounted. Fires the same belts as the Arasaka WXA Remote Weapon; cased or caseless ammo. [*Corpbook 1*]

**Howa Manufacturing Type-8 Medium Machine Gun: 2500eb**

VY	+1	N	P	6D6+2 (7.62MM)	100	35	VR	500M
----	----	---	---	----------------	-----	----	----	------

Standard support weapon of the GSDF. The ammunition is supplied in a 100 round caseless ammo pack, with belt-style feed. A 2000-round "backpack" is also available. [*Pacific Rim*]

# HEAVY WEAPONS

Unless otherwise noted, all weapons use cased ammunition.

**81mm Light Mortar: 750eb**

VY	0	N	P	8D10 (60MM)	1	2	VR	1000M/5M BURST RADIUS
----	---	---	---	-------------	---	---	----	-----------------------

Crew-served mortar, this weapon weighs 15 kg and comes in two pieces (mortar and base plate). It takes at least two men to operate efficiently; one man can operate it, but ROF slows to 1 per two combat turns. Shells cost 50 eb and weigh 1 kg apiece. The round listed is HE; other common rounds include smoke, illumination, and white phosphorus. See *Maximum Metal* for further details. [*Home/Brave*]

**Molt-Mauser M2X Cannon: 3050eb**

VY	0	N	R	8D10 (20MM)	8	1	ST	600M
----	---	---	---	-------------	---	---	----	------

This powerful semi-automatic fires full-size 20mm shells from an over-the-shoulder position. This allows for a long-travel recoil-absorption rod. A 15+ BOD roll is required to avoid 1-2pts. of bruise damage to the firing arm/shoulder (a critical failure results in dropping the gun). A 4x telescopic sight is standard; the weapon weighs 23kg loaded. [*Chromebook 2*]

**Commercial Grenade Launchers: 150eb**

VY	0	L	R	VARIABLE (30-40MM)	1	1	ST	225M
----	---	---	---	--------------------	---	---	----	------

These come from manufacturers worldwide, and may be attached to any assault rifle (under the barrel). Some can be given a simple shoulder stock for separate use. [*Cyberpunk 2020*]

**Senshira-Adachi F-253 Flamethrower: 1,500eb**

VY	-2	N	R	2D10	10	1	ST	50M
----	----	---	---	------	----	---	----	-----

Equipped napalm sprayer. Back-mounted and bulky, but very dangerous. The Soviet Union and certain NCE countries produce similar models. See *CP2020* for further details. [*Cyberpunk 2020*]





**Light Anti-tank Weapons: 300-800eb**

These are built as disposable weapons. Once fired, they are discarded. These weapons use compressed air or some other recoil-less non-backblast system for initial rocket launch, and are safe to use indoors! LAW dimensions: 60-70mm long and weighs 2 kg. HLAW dimensions: 85-105mm long and weighs 5 kg. *[Home/Brave]*

**LAW: 300EB:** HVY -2 L P 4D10AP HEAT 1 1 VR 100M/2M BURST RADIUS  
**HLAW: 800EB:** HVY -2 N P 11D10AP HEAT 1 1 VR 100M/4M BURST RADIUS

**M-32 Automatic Grenade Launcher: 2500eb**

HVY 0 N R VARIES (40MM) 50 20 VR 1600M

The auto-GL is a tripod- or vehicle-mounted weapon that spits out grenades at a ferocious rate of fire. It has all but replaced the old 60mm mortar (the new 60mm mortar is coming close to replacing the old 81mm mortar) as a fire-support weapon. It can use normal 40mm grenades, but only in single-shot mode. Normal 40mm grenade launchers cannot use the high-velocity grenades used in the auto-GL, since these high-velocity rounds are half again the length of a normal 40mm grenade. *[Home/Brave]*

**M-205 Grenade Launcher: 250eb**

HVY +1 L P VARIES (40MM) 1 1 VR 200M

The M-205 is the military's 40mm grenade launcher. The M-205 is usable as an under-barrel weapon, attached to a rifle. It is also usable as a weapon on its own. It is a single-shot, breech-loading grenade launcher, made out of polymers and composites. Other than that, it is not notably different from the launchers in existence 45 years ago. *[Home/Brave]*

**M-212 Grenade Launcher: 500eb**

HVY +1 N P VARIES (40MM) 8 2 VR 200M

The M-212 launcher is a bulky, rifle-sized weapon, with an 8-round revolving cylinder. The firer can select which round he wants to fire that combat round, but this slows ROF to 1. Range 200 meters. *[Home/Brave]*

**Militech AM-3 "Anti-Matter Rifle": 6000**

HVY 0/+1 N R 9D10 (30MM) 5 1 ST 1600M

This 30mm rifle uses rocket-boosted, depleted-uranium 30mm shells to smash combat 'borgs, powered armor, and light vehicles. Though equipped with a hydro-pneumatic recoil system, advanced muzzle brake, and shock-absorbing stock and bipod, it still requires a 15+ BOD roll to avoid 1-3pts of bruise damage to the firing arm (a critical failure results in dropping the weapon). Warning: Do not fire this weapon while standing unless you have a linear frame of Beta or greater, or you will be knocked down and the bruise damage doubled! The AM-3 comes with a cyberoptic smartgun interlock and a 2-10x variable scope w/low-light and thermal-imaging options. 30mm DPU rounds are 100eb each. Note: Because of the rocket boost there is a "safe zone" of 160m from the muzzle where the Acc is 0 and damage is 1/3; between 160-800m, Acc is +1 and damage is 1/2; from 800m+, Acc is 0 and damage is full. *[Chromebook 2]*

**Militech "Cowboy" U-55 Grenade Launcher: 900eb**

HVY 0 N P VARIOUS (25MM) 12 3 ST 150M

This is a multiple-round, semi-automatic grenade launcher designed specially for use in urban situations. It fires a variety of specialized and all-purpose rounds from a rotating drum magazine. The grenades are 25mm projectiles similar in appearance to large shotgun shells. The weapon may be fired semi-auto or in three-shot bursts. Any combination of loads may be in the magazine. A common technique is to use three-shot bursts, and load the weapon so that each salvo fires one frag, one concussion and one incendiary round. For riot control, similar combos of flash, gas and shotshell rounds are used. The launcher can be smart-linked, and has an integral optical sight. Light weight and a stubby design make the weapon ideal for the close confines of urban combat. Popular with riot cops and the 'borg squad. Militech is currently selling these weapons to Corporate security and police only. Loads: Fragmentation (3D6/3m radius), Flash (50% chance of -5 to REF and Awareness for 3 turns/5m dia.), Incendiary (4/2/1D6 for 3 turns; ignites flammables in 1m radius), Concussion (3D6/4m dia., armor x1/3), and all standard gas and smoke loads. 30eb per round. *[Corpbook 2]*

**Militech Hotshot L-ATGM: 2500eb**

HVY +2 N P 12D10AP HEAT 1 1 VR 500M/4 METER BURST RADIUS

The Hotshot is a wire-guided light anti-tank missile. The launcher is a tube that boosts the missile onto the battlefield with a recoil-less rifle-style blast of compressed air, to avoid tell-tale heat signature. The Hotshot is typically thermograph-equipped, but can be made laser-guided or even outfitted with simple optical guidance. Each missile costs 1500eb. *[Home/Brave]*

**Militech Mini-Grenade Launcher: 255eb pump model, 475eb drum model**

**PUMP:** HVY -1 L C VARIES (25MM/10GA) 4 2 ST 150M  
**DRUM:** HVY 0 N P VARIES (25MM/10GA) 16 2 ST 150M

Militech has developed a new grenade projectile sixty percent smaller in size (25mm x 70mm), but having the same range and effect as the standard 40mm grenade. Two styles of launcher are sold by Militech. The first is a pump-action, shotgun-style



launcher with a tube magazine holding four rounds. This version is the one normally mated onto Militech's M-31a1 Advanced Infantry Combat Weapon, or the Militech 10 SMG. The second design has a large rotary drum with a sixteen-round capacity, constructed on a modified Militech 10 frame. This weapon's settings allow a shooter to select between the ammo types that have been loaded. For example, the shooter could fire a tear gas shell, select an HE round, fire it, then select a flechette round, all without reloading! The weapon automatically rotates the drum to place the specified type of round into the chamber. Both weapons can also use 10-gauge shotgun ammunition. Note: ROF drops to 1 if the shooter is selecting new ammo types between rounds. Mini-grenade munitions: HEP 5D6 (damage is 1/2 real, 1/2stun-only; armor has no effect and is damaged 2 levels.), Fragmentation 2D6+1 (5m diam.), Antipersonnel Flechette 1D6AP (1D6+2 hits/shot), Smoke or Tear Gas (5m dia., see CP2020 effects). 30eb per round. [Chromebook 1]

### Militech RPG-A Grenade Launcher: 1500eb

/Y -2 N R 6D10 1 1 VR 750M

Shoulder-fired rocket-powered-grenade launcher. Heavily used in the Central American Conflicts. [Cyberpunk 2020]

### Militech Scorpion 16 Surface-To-Air Missile: 1000eb

/Y -1 N P 7D10 1 1 VR 500M/6M BURST RADIUS

The third generation of the Stinger missile launcher, the Scorpion is a standard heat-seeking active surface-to-air missile with tactical memory guidance backups. It's a "fire and forget" missile, automatically tracking the target once it is locked on. [Cyberpunk 2020, Home/Bravel]

### Militech Urban Missile Launcher: 900eb

/Y +2 L P 4D6 (MISSILE) 12 2 ST 200M

#### UNDERBARREL MISSILE POD:

/Y +1 L P 4D6 (MISSILE) 1 1 ST 200M

This magazine-fed, shoulder-fired weapon fires the same self-guided, heat-seeking, explosive-tipped, rocket projectiles as the perarm launcher. Also available is the MicroMissile Pod, a muzzle-loading 1-shot launcher designed to be mounted under any shoulder firearm (cost of pod is 200eb+50eb for initial installation). See the MicroMissile entry for rules on using these weapons. [Chromebook 2]

### Linemetal EMG-85 Railgun: 11,370eb

/Y +3 N R 5D10+10 (EAP) 5 1/2 ST 1500M

This electromagnetic gun uses superconducting technology to launch a 15-gram Mylar-coated Lexan slug at 8000fps! The weapon has an integral magazine with 5 power loops and a 5-round projectile pack. Power charging for the ammo unit costs 200eb. Weapon weight, 35kg. Notes: A minimum BOD of 11 is required to fire the weapon without a linear frame or ACPA. Therostabilized mount-harness (no smartchipping needed) has no MA penalty, but does have an EV of 1. Using the gun without the harness requires a min BOD of 12 and a smartgun link, plus -1 MA and EV of 2. Extra-AP effect is 1/4x armor, 1/2x penetrating damage. [Chromebook 2]

### Postovic Wrist Racate: 380eb

/Y 0 N P 5D6 (30MM ROCKET) 6 3 ST/UR 250M

From our friends in the Eastern bloc comes a new weapon, the "Wrist Racate." This consists of a cylindrical mini-rocket pod that rotates around a forearm fitting. It is capable of firing six 30mm HE rockets either singularly or in volley. Backblast is not a problem as each rocket is cold-launched by compressed air until ignition occurs about five meters from the launcher. Effective against personnel or structures (5D6/3m dia.), the Racate can also be used in an indirect artillery support role. If looks are secondary to firepower, then this is the personal weapon for you. The Wrist Racate must be worn over a cyberarm or battleglove; it is too heavy and awkward for a normal arm. Rockets are sold in packs of six for 200eb. [Chromebook 1]

### Royal Enfield Ordnance 25mm Cockerill Assault Cannon: 7400eb

/Y +1 N A 5D10+10AP (25MM) 12 1 ST 1500M

The first in a new range of anti-light vehicle weapons designed to complement/replace the LAW 80 and the Carl Gustav. The Cockerill cannon is a slightly scaled-down version of the 30mm weapon used in the Scimitar armored vehicle. To offset the immense potential recoil, the Cockerill uses low-pressure, rocket-assisted rounds. The round is fired by a reduced charge. When it travels 2m from the muzzle, the rocket motor ignites, boosting it to just over 800m/s (2623fps). Because of the firing system it's possible to fire the cannon from the hip—although it is not recommended (WA drops to -1). Only people with sufficient size (BOD of 8+) can do so; others must use the bipod. It requires a minimum BOD of 6 to carry and use this weapon due to its size and weight (encumbrance value +2). Rounds for this weapon include AP (armor-piercing; Pen 5), HEP (cratering; Pen 6), and APF (Anti-Personnel Flechette). Against personnel HEP does 1/2 real, 1/2 stun; armor is no effect and loses 2 SP. The APF round is treated as a shotgun round with a max range of 100m. The pattern starts 2m in front of the muzzle; sizes are 1m/close, 2m/medium, and 4m/long range. Anyone in the pattern takes 1D6+3 hits; each hit does 1D6+1AP. [Rough Guide UK]



**Towa Manufacturing Type-9 Grenade Launcher: 750eb**

HVY 0 N P VARIES (40MM) 8 2 VR 200M

It's a grenade launcher with a "revolver" cylinder, so you can choose your grenade type. For those who like to be prepared. [*Pacific Rim*]**Tsunami Arms Type-17 Anti-Armor Rifle: 7500eb**

HVY +1 N R 8D10AP (20MM AP) 12 1 ST 1200M

The Japanese SDF's special anti-ACPA/vehicle rifle. Supplied with bipod (+1WA Long/Ext range), computerized sights, and smartgun rig (raises WA to +3). Although this gun has a special recoil-absorption system, the gunner still suffers a formidable shock from shooting. Due to the weight and recoil, a minimum BOD of 14 (or the equivalent from a linear frame or full-'borg body) is required to shoot without the bipod and brace. The SDF or NPA guys wear light ACPA when they use this gun. This personal cannon uses cased ammo. [*Pacific Rim*]**Tsunami Arms Type-18 Automatic Grenade Launcher: 2000eb**

HVY -1 N P VARIES (25MM) 30 10 ST 200M

This bulky, bazooka-like weapon is connected to a heavy (25 kg) backpack-sized magazine of grenades, so you can rain them on your enemy. A magazine change requires at least 4 actions. SDF soldiers nicknamed it "The Pitching Machine." It has a gyro-balancer and recoil compensation, but the gunner will still suffer -1 REF and -1 MA from the weight and bulkiness of this thing. [*Pacific Rim*]

# 'BORG WEAPONS

**These are all weapons made for use by the fully cyberlimbed, Full Body Conversions, or ACPA. See the Recoil Rules on page 48 for more information.**

**Arasaka "Pocket Tsunami" Grenade Launcher: 1250eb**

HVY 0 L P VARIES (25MM) 6 1 ST 200M BOD MIN: 11 OR 23

The "Pocket Tsunami" is a revolver-style grenade launcher. The term "pocket" grenade launcher is also misleading. This is a small and very mission-specific weapon, more similar to a pocket-battleship than to a pocket-knife. This weapon gives full-conversion cyborgs a devastating primary support weapon and ACPA an awesome "handgun." This is a massive six-shot revolver-type GL. There are two configurations. The Cyborg-Support configuration resembles an Arwen Riot GL, but is more stylized and streamlined. This configuration has a fixed forend grip and no stock. The ACPA "handgun from hell" configuration appears as a BIG six-gun. In six-gun configuration the WA is decreased to -2. ('Borg support gun BOD min=11, ACPA pistol BOD min=23!) Weapon weight 8kg, magazine weight 1kg. [*Solo of Fortune 2*]**Grenades Types and Damage:** These are high-pressure mini-grenades and cannot be used in the Militech Mini-GL.**FRAGMENTATION:** 3D6+1, 5M RADIUS, 15EB**HE:** 5D6, 3M RADIUS, 15EB**HEP:** 5D6, (1/2 SP, ARMOR REDUCED 2 LVLS, 1/2 DAM. STUN), 25EB**INCENDIARY:** 4/3/2D6 OVER THREE TURNS, 2M RADIUS, 15EB**Arasaka "Rage" 15mm Submachinegun: 4500eb**

HVY -1/-2 L P 4D10+3(15MM KURZ) 20\* 1/10 VR 100M BOD MIN: 15

Arasaka has developed this concept as a primary anti-cyborg/light vehicle weapon system for full-conversions and ACPA. The weapon comes standard with a folding foregrip that stows conveniently (for use by full-conversions). Calling this weapon a submachinegun is not quite the truth; it describes the weapon's mission more accurately than its actual size. The 15mm Kurz round is based (loosely) on the 15mm round used in the BRG-15 HMG. The designers have discarded the necked-down casing for a simpler straight casing with about two-thirds the muzzle energy of the original design, though at greatly decreased range. This still allows for massive damage to armored personnel (including full-conversions and ACPA), armored vehicles, and structures. Currently, the only rounds available are a high explosive and a standard ball-type "practice round." This is a far stretch from the pistol-caliber SMGs of the original nomenclature. A selection of different finishes including stainless, basic black, and haute chrome are available. There are a variety of magazine sizes to fit any style from sidearm to primary weapon. If fired single shot then WA is -1. When fired full auto WA is -2. The weapon does not have burst fire capability. Due to recoil, at least an Omega-class linear frame or a full-conversion 'borg with a STR of 15+ is necessary for firing. Listed damage is for the steel-jacketed "practice round" (AP). Damage for the HE round is 3D10 explosive with a one-meter dia. Ammunition costs 8eb per shot for "practice rounds" or 20eb per shot for HE. (BOD min=15, see Recoil Rules on page 48). **Note:** Ten-round magazines cost 20eb each (empty). Twenty-round magazines are 40eb each (empty). The larger fifty-round magazines cost 100eb each, and lower the reliability by one category (to ST). Weapon weight is 8kg; magazine weight is 1kg (10), 2kg (20), and 5kg (50). [*Solo of Fortune 2*]



**Generic Full 'Borg Small Arms**

These are typical examples of the type of weaponry carried by combat-oriented full 'borgs. Most are retrofits of existing weapons, but some are actually custom-built for the 'borgs by weaponsmiths or autolathes. [Solo of Fortune 2]

<b>14MM HANDGUN—MAGNUM OPUS "BIG GOVERNMENT": 2000EB</b>									
P	+0	J	P	6D6 (14MM)	13	2	VR	60M	BOD MIN: 12
<b>12-GAUGE "PISTOL": 1000EB</b>									
P	-2	J/L	P	4D6 (12GA)	9	2	ST	30M	BOD MIN: 12
<b>5.56MM CASELESS "SMG": 1200EB</b>									
SMG	+1	L/N	P	5D6 (5.56MM)	50	25	VR	200M	BOD MIN: 10
<b>12.7MM "ASSAULT RIFLE": 2000EB</b>									
RIF	+1	N	P	6D10 (12.7MM)	50	10	VR	400M	BOD MIN: 12
<b>14.5MM "ASSAULT RIFLE": 2500EB</b>									
RIF	+1	N	P	7D10 (14.5MM)	50	10	VR	400M	BOD MIN: 14
<b>30MM HiVEL CASELESS AUTO-GL: 2000EB</b>									
HVY	+0	N	P	VARIABLE (30MM)	25	15	VR	300M	BOD MIN: 12

**Magnum Opus "Hellbringer".666 Magnum Revolver: 4000eb**

P	+1	J/L	P	7D6+3 (.666)	3	1	VR	80M	BOD MIN: 15
---	----	-----	---	--------------	---	---	----	-----	-------------

A massive double-action revolver, this huge weapon holds only three rounds in its solid titanium-steel cylinder, but each one is a .666 Magnum man-killer. It's a break-action design, engaged by a left-side thumb button. Each of the three steel-cased shells holds one .666-caliber lead slug which hits harder than most Magnum or Nitro Express hunting rifles! These rounds will put even the toughest armor to shame. The entire handgun is composed of steel and ultra-strong hybrid alloys (except for the ergonomic combat-style grips, which are made of neoprene), and the ported barrel has a heavy, full-length underlug for balance. While the Hellbringer comes with no fancy electronics, most owners supplement the blade-type sights with at least a laser sight; with only three shots, you have to make each one count! [Solo of Fortune 2]

**Malorian 3600 Super-SMG: 3000eb**

SMG	0/-1	L	P	6D6 (14MM)	20	1/3	VR	150M	BOD MIN: 11
-----	------	---	---	------------	----	-----	----	------	-------------

Basically, Malorian has rescaled the 14mm Caseless cartridge in a weapon too large to be called a submachine gun, and too short to be considered an assault rifle. You need a pair of cyberarms to fire the thing (or suffer some nasty damage, see Recoil Rules), and it is not very accurate in the base configuration, but it will pop Metalgear™ at point-blank range every time. Ammunition is 5eb per round. Magazines are 40eb each. WA is 0 for single shot, and -1 for three-round burst. The weapon is not capable of automatic fire. [Solo of Fortune 2]

**SlamDance, Inc. Hyper-Hammer: 2000eb**

MEL	-2	L	R	9D10AP	2	1	ST	2M	BOD MIN: 18
-----	----	---	---	--------	---	---	----	----	-------------

This is a close-combat weapon designed especially for full 'borgs. It is a heavy, solid-tungsten sledgehammer designed with ergonomic combat grips, spiked knuckle guards and a thumb switch-activated rocket booster built into the back of the hammer's head. When fired, the rockets blast the hammer around at near-supersonic speed, delivering unheard-of wound potential. Damage ignores soft armor and reduces it 2 levels, and hard armor only counts as 1/2SP and is reduced 1D6+4 levels. The Hyper-Hammer may be used two times before needing to be refueled (with jet fuel). The handle and grips can be folded down, so that a large person could conceal the Hyper-Hammer under a trenchcoat—this is made easier by the use of a special shoulder rig, available from SlamDance, Inc. for 40eb. [Solo of Fortune 2]

**Tsunami Arms Helix: 3000eb**

HGH	+0	N	P	5D6(10GA./#00)	60	43	VR	60M	BOD MIN: 15
-----	----	---	---	----------------	----	----	----	-----	-------------

This massive weapon is arguably one of the most devastating small arms for close-range house-to-house combat—a hex-barreled gatling shotgun which fires binary 10-gauge shells at 1300 rounds per minute! About one meter in length, the gun's six barrels are all a respectable 45cm long. The Helix has an inclined rear pistolgrip as well as a top-mounted fore-handle; it has no stock, since it was built to be fired "from the hip." To aid in aiming, there is a top-mounted laser-sighting system with adjustable pattern-matching capability. The Helix is constructed of high-tech composites and lightweight alloys, and weighs 15kg. Its projectiles consist of conventional 10-gauge slugs or packages of shot or flechettes stored in a synthetic canister. The ammo feed, centrally located beneath the tubular body of the gun, accepts either a belt feed or a box magazine which contains an ample supply of binary propellant and stores 60 projectiles; a rotor in the feed aligns the projectiles as it loads them. The weapon's binary propellant eliminates the bulk of a stabilizing element in its ammunition, and instead uses two gases which separately are stable, but are volatile when injected together into the ignition chamber. The design of the Helix keeps the line of recoil low and in line with the grip to lessen muzzle climb on full auto, and the six barrels, all rotating around a central axis, have long, flared muzzles with four compensation ports each. This, combined with the weapon's recoil operation, allows for relatively controllable autofire. The sound made by the Helix is distinct: a heavy, metallic scream. [Solo of Fortune 2]



**United Armaments CLAW: 1600eb**

SHG +1 N R VARIES (4GA.) 28 14 VR 60M BOD MIN: 11

**CLAW AMMUNITION LIST:**

#000 BUCK: ...8D6

SLUG: .....9D6+2

APFSDS .....5D10AP

HEAT: .....7D10 (1/2 SP).

Weighing in at 16kg and measuring over 1.2 meters in length, this Close Assault Weapon is designed for use by Combat 'Borgs and Powered Armor, and is totally unmanageable by unenhanced troops without a Powered Exo-Mount. The CLAW is a multi-role weapons package, consisting of a semiautomatic 4-gauge shotgun with a modular under-barrel support weapon, all housed in an all-weather, heat-resistant, impact-proof polymer/ceramic composite which is stronger than steel. The 4-gauge shotgun shell was a scattergun round used in the early 20th century to hunt ducks—traditionally, a 4-gauge gun would be bolted down to the stern of a boat, and then the entire boat would be pointed in the general direction of a flock (yes, a whole flock) of ducks or other fowl. After the smoke cleared, the hunters would collect the carcasses floating in the water. In 2020, the 4-gauge has been revived as an extra-high-lethality munition, using shell casings made of a heat-resistant and heat-absorbing plastic which acts as a thermal sink to ensure that the CLAW does not overheat. The 4" Magnum, 4-gauge shell has a bore diameter of 23.75mm (.935-caliber), as opposed to the traditional 12-gauge's 18.5mm bore, giving it the capability to fire an even greater array of sub-munitions than other shotguns. Buckshot (#000), "Beehive" flechette shells, slugs, APFSDS rounds, shaped-charge HEAT warheads, mini-grenades, non-lethal batons, "Dragon's Breath" thermite blasts, flash/bang bombs, "Slasher" mono-nets, cratering HEP rounds, and gas shells are all available. The bullpup CLAW feeds from a large 28-round box magazine, but the breech can be locked open to allow special rounds to be singly loaded, and the fully automatic firing rate is 425 rounds per minute. Beneath the barrel of the shotgun is an interchangeable underlug, which can be fitted with any one of the following support weapons: an 8-shot microwaver, a cartridge-loading Kendachi flame gun, a 4-shot pump-action 25mm grenade launcher, a 4-shot micromissile launcher or a small SMG (Concealability J). Whatever the support weapon is, its magazine loads forward of the CLAW's grip and trigger array and will have its operation slaved to the weapon's computer; the CLAW comes chipped from the factory, with IFF and security functions as standard features, making it fully compatible with ACPA fire-control systems and metalhead neural processors. This weapon is best known for its employment by the Detroit PD's C-SWAT Enforcer 'borgs. [*Solo of Fortune 2*]

# HAND GRENADES

**Basic Commercial, Corp & Military Grenades: 20-30eb**

HVY 0 P P VARIES 1 1 ST THROW

See definitions/effects below. [*CP2020, Home/Brave*]

**High Explosive:** This grenade does 7D6 fragmentation damage to all targets in a 5 meter radius, and 3D6 fragmentation damage to all targets within 6-10 meters.

**Anti-Tank:** This grenade does 5D10AP HEAT damage to any target directly hit by the grenade, and 3D6 fragmentation damage to any target within 5 meters. Normally only encountered in former East Bloc armies and some Third World nations. The drogue streamers needed to ensure proper impact cut the throwing range in half.

**Chemical:** This grenade carries gas, smoke, or paint, and has a radius of 10 meters.

**White Phosphorous/Incendiary:** This grenade does 4D6 damage for 3 turns to all targets within 5 meters, and sets fires very well. Damage is done by fragments of white phosphorous. Any soft armor attacked is reduced 2SP per round.

**Flash-Bang:** All people within 5 meters of the blast (15 meters if indoors) must make a Stun Save at -2 to avoid being stunned and deafened for 4 turns (40 sec.) and a Difficulty 20+ REF test to avoid being blinded for 2 turns (20sec.). Anti-dazzle protection negates the flash effect and makes the REF test unnecessary. Other versions have little discernable flash, but more concussive effect (no blinding effect; -5 to Stun Save). Soft armor gives no protection vs. the effects. [*Chromebook 2*]

**Flash:** All people within 10 meters of the grenade's flash must make a Difficulty 20+ REF test to avoid being blinded for 40 sec. Anti-dazzle protection negates the flash effect and makes the REF test unnecessary.

**Sonics:** An experimental type, popular in the EuroTheater. Essentially, a mini-voder box, with a 1-second play time and a one-use power source that fuses the unit into a lump. The burst of high decibels mixed with super- or sub-sonics causes all within a 6m radius to make a Stun Save at +1; if the save is made, make a Difficult BOD check or suffer deafness and disorientation (-2 all skill rolls) for 40 seconds. Noise-resistant headphones and various editing cyberaudio options allow you to resist the effects. Cost 40eb. [*Eurosource*]



**Biotech-Askari Motion Restraint Bomb: 60eb**

EX O P P SPECIAL 1 1 UR THROW

A fine, gossamer-web polymer material dispensed by hand-thrown bomb. It allows slow, steady movements, but clamps down instantly on quick or violent motion. 1m radius effect; a Very Difficult REF (use *Dodge/Escape* skill), or Near Impossible BOD (use *Strength Feat* skill) roll to get free. The release catalyst comes in a 10-use squirt tube (25eb); otherwise, wait 30-40 minutes for chemical breakdown. [Chromebook 1]

**DutchArms GPz-78 Mini-Grenade: 40eb**

HVY O P P HE/FRAG 1 1 VR THROW

A very small hand-thrown grenade (1.5" across) using an HDX explosive filler. Because of its size this grenade is very concealable, but its blast effect is limited to a 3m diameter (1D6+3 damage). Licensed to Gremyenko of Moscow by DutchArms Ltd. [Chromebook 1]

**EMP Grenade: 200-400eb**

EX O P R EMP EFFECT 1 1 UR/ST THROW

Are you a fifty kilo weakling? The metal dweeb next door won't tone down his chip box? Is your action being electromuscl'd by some borgboy in a bad thousand-yen suit? Put that chipped beef on toast with this "soon to be patented" Veg-o-matic Electromagpulse Grenade. Manually or remotely detonated, this munition will produce an electromagnetic pulse with a very limited range that will scramble electronics, wipe chip memory, and teach any chromedome how to do the Dying Cockroach. If you're interested in this or any other electronic marvels, lay a query line at Night City's Boogie Board for the "The Great Neeso." Note: When detonated, the EMP grenade does not explode, but fuses its internal mechanism five seconds after arming. Effects are similar to a Techtronica "Pulse Rifle" over a 4-10m diameter. Unshielded electronics and cyberware are immediately disabled. Internal cyberware comes back on-line in 4 minutes, and cyberlimb functions are regained in 10 minutes. Chips are wiped. Electronics/cyberware with hardening/shielding are not effected. A person with no cyberwear will still have orientation loss (make a Stun Save at -1, effect lasts 1D6 x10 seconds). [Chromebook 1]

**FEN Dz 22 "Saucer Grenades": 65eb**

HVY 1 P P HE/FRAG 1 1 ST THROW

These hand grenades have a liquid explosive filler in an aerodynamically saucer-shaped (4.5" dia. x 0.6" thick) grenade body (+2 to *Athletics* skill). Arming the grenade is achieved by turning the trigger button clockwise. Pressing the same button will allow a six-second delay before detonation occurs. One hundred sixty hardened steel pellets create a zone of fragmentation fifteen meters in diameter (damage 2D6+3). This grenade has a rubber edge to allow the user to carom it off objects. Because of the way one throws the grenade, colorful nicknames such as "Frisbee O' Death" and "Perforation-Puck" are often used to describe this product. [Chromebook 1]

**Ninja Smoke Pellets: 25eb/5 pellets**

Just pop one of these on the ground and vanish from your foe's sight. Flash powder that explodes on impact. Perfect for fleeing boosters or getting an advantage over more powerful adversaries. Just pray he/she doesn't have IR in his optics. A package contains five pellets. Note: Target is temporarily distracted and loses his/her next action. A Stealth roll is permitted to the pellet user to escape the area. [Chromebook 2]

**Scatter Grenade: 70eb**

HVY O P C SPECIAL 1 1 VR THROW

This grenade closely resembles a standard frag grenade. It has a 6-second delay after the pin is pulled. When the grenade discharges, it fills a 5m radius with smoke and harmless particles. The cloud is not only impenetrable to normal sight, it also makes IR and thermal imaging useless. The cloud lasts for 5 rounds in calm winds. [Chromebook 2]

**Spraypaint Grenade: 20eb**

HVY O P C SPECIAL 1 1 ST THROW

Good for the 'punk with a sense of humor. After pressing safety button, any sharp impact will detonate the grenade, sending paint over a 4m area. Paint comes in 15 vibrant colors. Note: Can blind a target for 1-2 minutes if caught in center of "blast." [Chromebook 2]

**Stench Bomb: 20eb**

EX O P C CHEMICAL 1 1 VR THROW

Best weapon to clear a room with. Few, if any, can stand the putrid odor that emits from the bomb after activation. The cloud covers a 5x5m area and sticks to any surface. Surfaces must be cleaned to remove the odor. Note: All those in area of effect not in protective gear (gas mask, nasal filters, etc.) must make a Very Difficult COOL or BOD roll (GM's choice) or flee the area. [Chromebook 2]





# LAUNCHED GRENADES

## Classic Rifle Grenades: 50eb

Hvy -3 N P VARIES 1 0.5 VR 100M

Rifle grenades were phased out of the U.S. Army in the mid-50's, but they're still popular with Euro armies and some U.S.-based Corporate forces. These grenades are fitted on the end of the rifle barrel, and are propelled by firing the rifle—the bullet is trapped at the end of the grenade, and the energy of the bullet striking the grenade propels it. The rifle cannot be used to shoot any targets with bullets while the grenade is in place. It takes one combat action to fit a rifle grenade to the end of a rifle. All rifle grenades use Heavy Weapons skill, have a Weapon Accuracy of -3, have an effective range of 100 meters, and cost 50eb. apiece. [Home/Brave]

**CHEMICAL:** This round carries gas or smoke, and covers a 10m radius.

**HE:** The high-explosive rifle grenade does 8D6 damage in a 5m radius.

**HEAT:** Shaped-charge does 8D10AP damage to the target, and does 4D6 damage to all other targets within 1m.

## DCR Rifle Grenades: 50eb; 100eb for Anti-Tank

Hvy -1 N P HE/SMOKE 1 0.5 VR 150M

Hvy 0 N P ANTI-TANK 1 0.5 ST 150M

With the addition of a 22mm muzzle adaptor (200eb), any rifle may fire the DCR line of rifle grenades. The use of a bullet trap design developed in the 1970's allows the shooter to fire conventional ammunition and also launch a rifle grenade up to 150 meters away! These small finned projectiles carry a warhead capable of doing as much damage as a standard grenade. It packs the same punch, but at a tenth the cost of a grenade launcher. Note: The muzzle fitting for launching grenades can be installed on any paramilitary rifle by a competent tech for about 50eb. See Hand Grenades for effects. [Chromebook 1]

## Militech 25mm Launched Grenades

See individual weapons for further details of weapon-specific loads. Effective range for 25mm grenades is usually 150 meters. [Home/Brave]

**Chemical:** This round carries smoke or gas and has a 5 meter radius. All 25mm grenades cost 30eb. apiece.

**Flechette:** This round does 2-12 1D6AP hits to the target.

**Fragmentation:** This round does 2D6+1 damage to all targets in a 5 meter diameter.

**HEP:** High-Explosive Penetration is actually a squash-head round, splashing a pat of plastic explosive onto the target before detonating. This round does 5D6 damage; armor has no effect and half of the damage is applied as concussion, half as real. Armor hit by an HEP round loses 2 points of SP. Concussion damage is a Stun/Shock Save. Subtract armor SP (if allowed) from the damage, up to half the damage total—that's right, at least half the damage goes through any armor except hard armors (i.e., Metalgear™, powered armor, full medieval armor). Then target must make a Stun/Shock Save as if it was damaged by the concussion damage that went through. The concussion damage is not entered on the character sheet as damage points! Rigid armor prevents any concussion damage from hitting the target; Skinweave has no effect on concussion damage.

## Militech 25mm Pistol Grenades

These are similar to DCR's rifle-fired grenades, but they are designed to be fired from pistol-caliber weapons. Any pistol or sub-machinegun's barrel can be fitted with a Militech-produced muzzle adaptor (200eb) in the appropriate caliber by a weaponsmith or techie (for about 50eb). The adaptor's bullet trap design allows the shooter to fire conventional ammunition and also launch a pistol grenade up to 100m away. These small, barrel-shaped (25x50mm) projectiles carry warheads with capabilities equal to standard 25mm Mini-Grenades. Note: Pistol Grenades cannot be launched by weapons of less power than 9mm, and 9mm through .45-caliber weapons will only have a Long Range of 15m! .357, 10mm and other, more powerful rounds will have a Long Range of 50m. [Chromebook 2]

- **CONCUSSION:** 3D6, 4M RADIUS, 15EB. DAMAGE IS STUN ONLY, ARMOR PROTECTS AT ONLY 1/3 EFFECTIVENESS.
- **DEFENSIVE FRAG:** 2D6+1, 3M RADIUS, 20EB. REDUCED EXPLOSIVE; SAFER FOR USE IN TIGHT CONFINES (LIKE ROOMS, HALLWAYS, ETC).
- **FLASH BOMB:** -5 REF & AWA, 5M RADIUS, 15EB. STUN SAVE EACH PERSON; -5 TO REF & AWARENESS FOR 5 TURNS.
- **HEP (CRATERING):** 5D6, NO RADIUS, 30EB. DAMAGE IS 1/2 REAL, 1/2 STUN ONLY; ARMOR HAS NO EFFECT AND IS DAMAGED 2 SP.
- **INCENDIARY:** 4D6 FIRST TURN, 3D6 SECOND TURN, 2D6 THIRD TURN; FLAMMABLES IN 1M RADIUS BURN; 30EB.
- **OFFENSIVE FRAG:** 5D6, 3M RADIUS, 25EB. HIGH-EXPLOSIVE FRAGMENTATION; VERY MESSY IN CLOSED AREAS.
- **SMOKE OR TEAR GAS:** 3M RADIUS, 20EB. SEE CP2020 RULES FOR GAS; TEAR GAS—TEARING & -2 REF, SMOKE OBSCURES VISION.



### Military 40mm Launched Grenades

Unless noted, all 40mm grenade rounds are availability R and cost 50eb apiece. High-velocity Auto-GL grenades cost 100eb apiece. *(Home/Brave)*

**Bean Bag:** This round is a "bean bag" of gel. It has an effective range of 50 meters, and does 2D6 damage to the target (this is actual bruising tissue damage). Armor stops this damage as normal. The target also has to make a Stun/Shock Save at -5, +1 per full 15 SP of armor that the target's wearing. In addition, the target must make a Difficulty 20+ REF roll to remain standing (the Difficulty drops by 1 per full 100 kg of target weight, so a 1,000 kg powered armor suit is much less likely to be knocked down).

**Chemical:** This round carries gas or smoke and covers a 10-meter radius with the appropriate chemical. Available in high-velocity version for auto-GLs.

**Flash-Bang:** A time-delay charge of blasting explosive and flash powder, the flash-bang round acts as a normal flash-bang grenade. All people within 5 meters of the blast (15 meters if indoors) must make a Stun/Shock Save at -2 to avoid being stunned and deafened for 4 turns and a Difficulty 20+ REF test to avoid being blinded for 2 turns. Anti-dazzle protection negates the flash effect and makes the REF test unnecessary. The flash-bang round has a maximum range of 25 meters; if it has not impacted something solid (exploding on impact) by that time, it explodes automatically.

**Flechette:** This round does 1-3 2D6AP hits to all targets in a line of fire that extends from a point three meters in front of the firer to a distance of 25 meters. This line of fire is 3 meters wide. Just like shotgun blasts, this fire cannot be avoided; anyone in the cylinder of flechettes takes damage.

**Grapnel:** This round comes in three parts. The propellant charge (5eb.) is breech-loaded into the launcher. The grappling hook (25eb.) is loaded into the muzzle of the launcher, and the line (1eb per 20 meters) trails from the hook. The grappling hook and line are so heavy that they cut the effective range in half. The round has a Weapon Accuracy of -2; this is to hit the target. If the target is hit, it takes 1D6 blunt damage and the grapple catches on 50% of the time (lower the percentage for smooth areas and raise it for target areas full of projecting objects that the hook can catch).

**HE:** This round does 7D6 damage in a 5 meter radius. It will not detonate until it has traveled 10 meters from the weapon after firing. Available in high-velocity version for auto-GLs.

**HEDP:** This round does 4D10AP HEAT damage to the target, and 4D6 damage to all other targets within one meter. Available in high-velocity version for auto-GLs.

**HEP:** A 40mm version of the 25mm HEP, it is WA -1, does 7D6 damage (half goes through, half is concussion), and armor is reduced by 5 SP.

**Illumination:** This round is a flare that illuminates everything within 20 meters of the flare. If it hits a person or other target, it does 1D6 damage per round for 6 turns. It will not detonate until it has traveled 10 meters from the weapon after firing.

**Net:** This capture round shoots a small (2m) net that wraps around the target. It has a Weapon Accuracy of -5, an effective range of 25 meters, and does 1D6 damage (from the mass of the net weights striking the target at velocity). A hit has a 50% chance of wrapping the net around a man-sized target, immobilizing the target. A Difficulty +25 Strength Feat is necessary to rip free of the net, or the net can be cut off (the netted target has to make a Difficulty +20 REF test to get a cutting tool free; targets with scratchers, rippers or wolvers can start cutting immediately). It takes two combat turns (20 seconds) to cut free of the net.

**Splatshell:** One of the most unique riot control weapons to ever come down the pike, the SplatShell is a submunitions dispenser of a different sort. Loading 20 16mm splatball rounds into a special sabot (for 30mm/40mm launched grenades), the SplatShell can spray a 10-meter area with your favorite splatballs ... virtually guaranteeing a hit! See *CP2020* for splatball effects. The SplatShell is treated just like a shotgun blast, but all pattern sizes are doubled (2m at Close range, etc.), and any target will be hit with 1D6+1 splatballs ... which can be of any type, but must be selected ahead of time. Munitions can be mixed ... Referee's discretion as to which types hit whom. Cost is 10eb, plus the cost of the Splatballs.

**White Phosphorous:** This nasty round throws a cloud of burning white phosphorous. Anyone within 10 meters of the explosion takes 4D6 damage for three turns.

# MINES & EXPLOSIVES

See the new Explosives/Demolitions rules in *Listen Up, You Primitive Screwheads* for further details.

### Antipersonnel Mine: 350eb

HVY 0 J P 4D10 (PEN 2) 1 1 VR N/A

Can be detonated by direct contact, timer, tripwire, remote signal or motion detector. A typical example is the Militech M25AP with a 7m blast radius. *(Cyberpunk 2020, Home/Brave, Chromebook 3)*





**Antitank Mine: 400eb**

HVY 0 L P 6D10AP (PEN 6) 1 1 VR N/A

Most antitank mines weigh 15 kg and go off when 150+ kilograms of pressure are applied to them. They can be detonated by remote wire or direct contact; the typical example is the M26AT by Militech. Antitank mines do 6D6 damage (Pen 1) to all other targets in a 2-meter radius. Setting an antitank mine takes 5 minutes; concealing it takes another 5 minutes. There are also anti-vehicle mines that are essentially remote-sensor fired LAWs or HLAWs, attacking the rear or flank of their targets. See Light Antitank Weapons entry for details. Cost 600eb. [Home/Brave, Chromebook 3]

**C-6 "Flatfire" Plastic Explosive: 100eb/kg.**

HVY 0 P P 8D10/KG 1 1 VR N/A

Grey block of plastique, can be detonated by timer, tripwire or signal. The basic blast radius for C-6 is 5m. [Cyberpunk 2020, Listen Up/Primitive Screwheads]

**Claymore Mine: 500eb**

HVY 0 L P 4D10 1 1 ST N/A

Claymores are designed to stop people with a spray of projectiles. Claymores can be triggered by tripwire, time delay or remote wire. These mines have an hourglass-shaped area of effect: a "front cone" 6m wide x 75m long, and a "rear cone" 6m wide x 6m long joined by a 6m diameter circle. The effects are similar to a shotgun. [Cyberpunk 2020, Home/Brave]

**Explosives Field Kit: 1500eb**

Necessary to work with most explosives. It weighs 30 kg, and contains 100 blasting caps (50 electric, 50 non-electric), demolitions tools (wire cutters, pliers, knives, etc.), 200 meters of electrical wire, 500 meters of trip wire, an electrical plunger, 5 digital timers, 5 pull-release "trap" detonators for booby traps, and hundreds of meters of various fusing cords. [Home/Brave]

**FEN Dz 25 "Det Card™": 120eb**

HVY 0 P P HE 1 1 ST N/A

Another nifty new design from those clever folks at Fabrique Europa Nationale. The Det Card™ is a credit-card sized wafer of Plastique, stabilized with a plastic shell, and ignited by a tiny detonator chip imbedded in the card. Simply snap the card in half, place it where desired, and it will explode in twenty seconds. Just right for noisy B&E jobs. Available in Trauma Team™, Euro-Worldbank, and WNS press card formats. For damage purposes, treat it as 1/100 of a kilo of Plastique doing 1D10 with a 0.25m blast radius. [Chromebook 1]

**Militech PDU-3 Multi-Purpose Perimeter Defense Unit: 150eb**

HVY 0 P P 2D6+5 1 1 ST N/A

The PDU is a 75mm square x 20mm thick box with a sensor, controls and a microcell power unit. Designed to be sown as perimeter defense or set to discourage pursuit, the unit contains a small but potent explosive charge. The casing is made of ceramic to produce a fragmentation effect over a 5m diameter. The PDU can be set to fire from a variety of triggers or any period of time delay up to 72 hours. While the unit can accept input from almost any type of military sensor, it comes with a passive IR motion detector and a tripwire. There is also a magnetic or chemical glue strip for attaching the PDU to various surfaces. Militech sells an optional gas-throwing type with no fragments and a similar burst radius. [Chromebook 2]

# AMMUNITION

**Ammunition and Reloads for Firearms: Prices vary**

Prices listed are for caseless ammunition; brass-cased loads cost 3x the regular price, but plasticase ammo can also be used in old guns (same cost as caseless, but P availability). Note that drug loads for Needleguns are also available at 5x basic cost (i.e., 250eb per box of 100). [Cyberpunk 2020]

LIGHT PISTOL & SMG, PER BOX OF 100	15EB	AIRGUN PELLETS, PER BOX OF 100	6EB
MEDIUM PISTOL & SMG, PER BOX OF 100	30EB	ACID OR DRUG PELLETS, PER BOX OF 100	30EB
HEAVY PISTOL & SMG, PER BOX OF 100	36EB	NEEDLEGUN ROUNDS, PER BOX OF 100	50EB
VERY HEAVY PISTOL, PER BOX OF 100	40EB	20MM CANNON ROUND, EACH	25EB
ASSAULT RIFLE, PER BOX OF 100	40EB	FLAMETHROWER RELOAD	50EB





**API—Armor Piercing Incendiary: 4x basic ammo cost**

In the old days, guns were called “heaters.” That name applies once again, thanks to the remarkable new API rounds. These cartridges fire metal-jacketed, sharp-nosed slugs which cut through most armor with ease, but these slugs pack a surprise: Each bullet is composed of a solid chemical compound which combusts in a reaction to high-pressure impacts. The overall effect is a bullet which, upon impact, becomes incredibly hot, searing the insides of its target. Just try not to get in a firefight in a paper factory. Notes: API ammo acts as normal AP ammo (armor SP is halved but so is damage vs. flesh), but if the bullet penetrates its target’s armor, it does an extra 1D6 damage the first turn, and 1D6/2 damage the second turn. API rounds may ignite any flammables they hit (50% chance). Cannot be fired from guns with Electrothermal Enhancement. [*Chromebook 2*]

**Armor-Piercing Rounds: 3x basic ammo cost**

AP bullets have a steel jacket or core meant to penetrate various forms of armor. The effects are armor SP x1/2 and penetrating damage x1/2 as well. This is because such bullets have little or no expansion, and therefore reduce true damage. [*Cyberpunk 2020*]

**Dual-Purpose Rounds: 4x basic ammo cost**

Gone are the days when you might accidentally bring AP bullets to a nudist colony, or normal ammo to a Body Armor manufacturer’s convention. Dual-Purpose ammo gives you the best ballistics for the best situation; DP rounds consist of a dense, sub-caliber penetrator core of tungsten steel wrapped in a sheath of soft, quickly-mushrooming lead. When these rounds hit armor, the lead sheath strips away while the penetrator continues through to your target. However, when these rounds hit flesh, the lead squashes out to cause a massive wound cavity. In any situation, Dual-Purpose rounds leave little to be desired. Notes: When DP rounds hit an armored target, they treat it as 1/2 SP but do 1/2 damage to flesh. If the target is unarmored, they do 1.5x normal damage. [*Chromebook 2*]

**Electrothermal Ammo Enhancement: 1.5x basic weapon cost**

Overcome the laws of physics! The maximum speed a bullet can be accelerated with gunpowder (around 6,500 feet per second) and the pressure spike created by a gunpowder gas explosion have always limited the capabilities of firearms technology—until now. Take your firearms beyond the limitations of the last century with Electrothermal Enhancement. By modifying the breech lock, adding a battery pack, insulating the weapon and using high-tech ammunition, a firearm’s muzzle energy can be doubled! (Without blowing apart, too!) Electrothermal (ET) ammunition has the same cartridge dimensions as regular cased loads, but instead of a primer and powder, ET guns employ an electrical pulse and a liquid working fluid. This liquid can be anything from methanol to water, but it must be primed with around 10,000 amps. This energy pulse causes the liquid to combust, changing its state to plasma, which pushes the bullet down the barrel at incredible velocities. ET guns can also modulate barrel pressure with a throttle, controlling the energy in the priming process with a safe time/pressure trace. As an example, a 5.56mm bullet has a muzzle energy of 1330 foot-pounds, while an ET 5.56mm has a muzzle energy of 2764 ft-lbs! Note: ET enhancement insulates the gun against electrical surges, modifies it to accept a 100-shot battery (150eb), and replaces the hammer with an electrode: The result is that the gun’s performance is increased by 50%—both damage and range. The procedure can be performed by many arms factories and some gunsmiths (Poor availability, *Weaponsmith* skill vs. 25+). Price is equal to 50% of the weapon’s base cost, and adds 0.5-1kg to the weapon. Only weapons which used **cased** ammo can take advantage of ET enhancement (this generally means 20th-century guns), and the enhancement is only useable with semi-auto and manual repeater actions (bolt-, lever-, pump-action). ET ammo costs 2x normal cost, and can be bought as AP. [*Chromebook 2*]

**Hollowpoints: x1.125 basic ammo cost**

Special hollow-nosed ammo made of soft, quickly mushrooming lead. When these rounds hit armor, the lead flattens bluntly and does mostly bruising damage. However, when these rounds hit flesh, the lead squashes out to cause a massive wound cavity. In effect, these rounds treat all armor as having 2x normal SP, but damage that penetrates is x1.5. [*Chromebook 1 & 2*]

**Kendachi Fragmentation Flechettes: 5x basic ammo cost**

This ammunition, manufactured by the Kendachi Corporation, consists of a synthetic-cased or caseless cartridge which fires a subcaliber alloy flechette. These sabotaged, fin-stabilized arrows travel at impressive speeds (up to 4,000 feet per second), giving them superior armor penetration ability. They are also injected with a near-microscopic filling of a C6-style plastic explosive, and are chemically time-delayed to detonate a micro-second after impact. Using this design, the needle-like projectiles are able to successfully penetrate armor without suffering from overpenetration. The classic problem with flechettes is this: Being of very small diameter and traveling at extremely high velocity, a flechette may pass directly through the target and leave only a tiny (and ineffective) hole in the body. To overcome this, Kendachi’s fragmentation flechettes pack just enough explosive to break themselves apart once they enter the body, thereby creating a devastating wound cavity. Notes: Kendachi’s Fragmentation Flechette ammo is available for any weapon at 5x the cost of regular rounds; they treat soft armor as 1/2 SP and do normal damage to flesh. Beware—these rounds are Rare availability and very illegal. Usually found with Orbital weapons. Cannot be fired from weapons with Electrothermal Enhancement. [*Chromebook 2*]



**Rubber Bullets: 1/3x basic ammo cost per box of 50**

Many ammunition manufacturers have produced a variety of "Less-Than-Lethal" ammunition. They cannot be called non-lethal, as many are very dangerous if not used at the proper ranges; damage is Stun only beyond 3m. Below that range, 1/2 is real, 1/2 is stun.

**Safety Rounds: 6x basic ammo cost**

Another solution to firepower in pressurized environments is to employ safety rounds. Designed in the 1980s for aircraft terrorist control, safety rounds will break up against even a thin metal hull. This makes them less effective against armor, but deadly vs. soft targets (armor SP is x2, but penetrating damage is x3). Any hard surface of greater than 10SP or 30SDP will cause the round to burst harmlessly. Available only to police and security forces. *[Deep Space]*

**Shotgun Ammunition: 15eb per 12 Shells**

Shotshells (which are cased) are considered the standard shotgun round, capable of spraying a load of shot into an area. 3D6 for 20-Gauge, 4D6 for 12-Gauge, 5D6 for 10-Gauge. Rules as per *Cyberpunk 2.0.2.0*. *[Chromebook 2, Home/Brave]*

**APFSDS:** Armor-Piercing Fin-Stabilized Discarding Sabot is a sub-caliber round, firing a 5.5mm projectile from a 12 or 10ga shotgun. This sub-munition moves at accelerated velocities and easily punches through armor. It costs 10eb per round, and does 6D6AP damage. It has an effective range of 25 meters.

**Flare:** Cost is 25-30eb per box of 25; Lights up an area of 30m diam. Causes 2D6+2 and 1D6/2 per round fire damage if fired as a regular shell.

**Flash-Bang:** A small time-delay charge of blasting explosive and flash powder, the flash-bang round acts as a small flash-bang grenade. All people within two meters of the blast (5 meters if indoors) must make a Stun/Shock Save and a Difficulty +20 REF test to avoid being stunned for one turn and being blinded for two turns. Anti-dazzle protection negates the flash effect and makes the REF test unnecessary. The flash-bang round has a maximum range of 25 meters; if it has not impacted something solid (exploding on impact) by that time, it explodes automatically.

**Flash:** 30-35eb per box of 25: Act as a flash-bang grenade in a shotgun pattern 25m deep by 3m wide (see Flashbang Grenade).

**Flechettes:** This round costs 8eb apiece and works like a regular shotgun shotshell, except that it fires needles instead of shot, doing 4D6AP damage (armor and damage is x1/4).

**Gas:** This round carries a gas pellet that effects all targets within 1 to 2 meters of the burst. The gas acts like a dose of whatever poison/drug is put into it. Tear and nausea gas rounds cost 5eb apiece, hallucinogen and sleep gas rounds cost 10eb apiece, and biotoxin gas rounds cost the military 25eb apiece (they're unbelievably rare on the civilian market).

**HE:** High Explosive rounds turn the shotgun into a mini-cannon. HE does 4D6 damage in a 1/2m radius, per shell fired. So a barrage of 10 shells would do 4D6 damage to everything in a 5 meter radius of the point of impact. HE shells cost 5eb apiece.

**HEAT:** A shaped-charge shell that does 4D6AP damage, but any damage that surpasses target SP is passed on to the target at full value, just like any other shaped-charge munition.

**Non-Lethal:** A non-lethal gel or rubber round that does concussion damage to the target. Concussion damage (otherwise known as bruising) takes the form of a Stun/Shock Save. If a target is hit by a gel round, roll 4D6 for damage. Subtract armor SP from the damage, up to half the damage total—that's right, at least half the damage goes through any armor except hard armors (i.e., Metalgear™, powered armor, full medieval armor). Then the target must make a Stun/Shock Save as if it was damaged by the concussion damage that went through. The concussion damage is not entered on the character sheet as damage points! Rigid armor prevents any concussion damage from hitting the target; Skinweave has no effect on concussion damage. All targets, whether affected by the concussion or not, must make a Difficulty 10 REF save or be knocked down by the impact.

Example: Patrolman Casey uses his automatic shotgun to spray an area with gel rounds. Gangers Chipper and Grunt are in the area and are hit. Chipper is wearing a Medium Armor Jacket and Skinweave; Grunt is wearing Metalgear™. Chipper's gel round does 15 points; his armor jacket would normally subtract 18, but half the damage (8) goes through, leaving him a Stun/Shock Save modifier of -1, just as if he had taken a Serious wound. He's not really hurt, but he fails his save and collapses, clutching his bruised torso. Grunt, wearing his heavy rigid armor, fails to receive any damage, but has to make a +10 REF roll. Encumbered by his armor, he fails and falls backwards, knocked down by the kinetic energy.

**Slugs:** A solid shotgun round, using one large, rigid-core bullet instead of shot. The slug does 3D6+1 (20-Gauge), 4D6+2 (12-Gauge), 5D6+3 (10-Gauge) damage at all ranges, and has no area effect. The round is AP; any damage that penetrates hard armor is not halved.

**Smoke:** 15-20eb per box of 25. No damage, but obscures a 3m circle with dense smoke.

**Stingers:** 12-Gauge shells cost 15eb per box of 25; damage is Stun only beyond 3m. Damage is 4D6 under that range. 10-Gauge shells cost 20eb per box of 25; damage is Stun only beyond 9m. Damage is 5D6 under that range.

**Stundart:** Improved product design from Pursuit Security, Inc. A Stundart round that can be fired from any shotgun or 25mm mini-grenade launcher up to 100m. Its larger capacitor results in a -2 to Stun saves, and soft armor up to 10SP can be penetrated. Cost: 20eb (per pack of four).

**Thermite:** Thermite rounds shoot a narrow spray (1/2 width of a shotgun pattern) of the burning metal into the target. The material burns into the target at over 3,000 degrees, melting through almost anything. The round does 8D6AP. This damage is healed at 1/3 the normal rate. For every thermite shell (over five) fired through a specific shotgun barrel there is a 1 in 10 additive chance of warping and ruining the barrel. Thermite rounds cost 30eb apiece.







# SPECIAL AMMO

## **ARROWS: Prices vary**

Self bows require the Archery skill to fire effectively, since they are used and aimed very differently than crossbows. Crossbows use either the Archery skill, or the Rifle skill at half value (the "Handbow" can be fired with Pistol skill at half value instead of Archery skill). Range: Arrows and quarrels lose energy over time more swiftly than bullets. An arrow or quarrel shot at Extreme range only does 1/2 damage. The number of shots listed for each bow aren't held in some sort of magazine. No, they're in a quiver or other arrow holder, so in order to reload your bow or crossbow, you have to reach down/back/out to it and grab the arrow/quarrel before transferring it to your string. Please note that this can become difficult in tight spaces. [*Solo of Fortune 2*]

**Target:** The basic arrow/quarrel (bows use arrows, crossbows use quarrels). Halves all armor SP, does normal damage. 12 arrows/24eb, 12 quarrels/30eb.

**Broadhead:** An head consisting of two or more razor-sharp blades. Acts as a knife for armor penetration, penetrating damage is doubled. 12 arrows/40eb, 12 quarrels/50eb.

**Stun:** This arrowhead is a blunt ellipsoid. All damage is stun. 12 arrows/20eb, 12 quarrels/25eb.

**Spinner:** A vicious arrow with a hardened target point that springs into a broadhead inside the victim. Furthermore, the arrow rotates in flight, drilling a 20mm+ hole through the victim's flesh! Acts as a knife for armor penetration, penetrating damage is tripled. 12 arrows/80eb, 12 quarrels/100eb.

**Warhead:** A standard 25mm pistol grenade (*Chromebook 2*, pg.48) can be fitted onto an arrow and shot from any bow with a 20-kilo or greater pull. This reduces WA by -2 and halves the effective range of the bow. The "Arbelest" and "Scorpion" crossbows are exceptions to this; they suffer the -2 WA penalty, but retain their normal ranges (these monsters already throw massive bolts; the grenade's not heavy enough to make a difference).

## **Constitution Arms Multiple-Purpose 12mm Ammunition for the CA MAP 12mm Pistol: Prices vary**

Being designed for the Multiple-Ammunition Pistol revolver, these rounds are brass-cased rounds and are thus not compatible with any other 12mm handgun. Furthermore, the bullets fired from these cartridges are, in fact, slightly larger than 12mm caseless bullets, to prevent them from being used in other 12mm weapons. See Constitution's Multiple-Ammunition Pistol (page 16) entry for further details. [*Protect & Serve*]

**Standard Round:** These are general purpose 12mm cased shells with a 50m effective range, causing 4d6+1 damage. A box of 50 sells for 20eb.

**Hyper-Penetration Round:** Uses principle similar to Dual-Purpose ammunition, but designed for less lethality against unarmored targets. Consists of a lead slug surrounding a cadmium rod core with a higher than average propellant mass to provide an increase in velocity. If the round hits a soft target, it will mushroom like a standard round. However, upon impacting an armored target, the lead slug is halted, allowing the cadmium rod to penetrate the armor. The round does 4d6+1 and is treated as armor-piercing or normal, whichever does the most damage to the target. A box of 50 rounds sells for 60eb.

**Chemically Propelled Dart Round:** This round has a reduced propellant load to accommodate a small dart in its tip, capable of delivering toxins of various types. A CPD has a range of 45m and inflicts 1d6 damage plus any effects caused by the toxin payload. It is considered AP vs. Soft Armor (i.e., leather, Kevlar-T, Lt. Armor jacket). Constitution Arms only sells sleep darts (officially). A box of 50 rounds sells for 40eb.

**Chemically Propelled Capsule Round:** Three types of CPC are available, each designed to release their payloads upon contact with a solid object, breaking the capsule within the slug body. The three types are a paint round used mostly for training, a sleep round favoured by many riot units around the world, and an acid round (with a variety of uses, not against human targets; treat acid capsule as airgun load, 2 rounds duration). The round has a reduced propellant load, and thus only has a range of 45m. A box of 50 paint shells costs 25eb, while the sleep and acid rounds both sell for 40eb per 50 shells. It is also possible that other payloads could be used.





**Chemically Propelled Taser Round:** A relative breakthrough in taser technology. This shell avoids the problem of the taser's limited range by using a chemical propellant with the taser built into the projectile. Upon impact, the round causes 1d6 damage plus the usual taser effects. However, due to the low power of the weapon, all saves against the effects of the weapon are at +2. There is also a 1 in 10 chance that the impact will cause the taser to malfunction and fail to release its charge. A box of 50 of these rare rounds costs 80eb.

**Explosive Round:** Designed for the rapid "lock-picking" that police so often have to carry out, this round is an effective anti-personnel weapon as well. The impact-activated warhead is formed of an experimental explosive with a far greater explosive yield than existing types. The range is 50m and the explosion causes 2d6 damage in a 1m blast radius. A box of 50 sells for 100eb.

### **Flechettes and Bolter Ammo: Notes**

Flechette weapons trade projectile speed for penetration. The flechette is thrown by a very low-powered shotgun-type round firing several flechettes at once. Bolt throwers are heavier flechette weapons which throw a single thick bolt. Neither of these weapons can deliver enough impact to penetrate a hull (except at Point Blank range for Bolters), but because they are designed to pierce, they will halve the SP of any body armor they encounter. In space, where even a small rip is enough to send your enemy scurrying to a patch kit, big damage isn't quite as critical. Also, both types can be coated with poison or narcotics for added effectiveness. See relevant weapon entries for further details. [*Deep Space*]

### **Gyrojet Ammo: Notes**

Gyrojets use a self-propelled rocket shell. A powerful spring launches the shell, which coasts about a meter from the barrel before igniting. No recoil, no mess. There are a few problems with gyrojets. First, they are next to useless at close range, as the rocket shell is only spring-powered. It takes a good five meters of travel before the round accelerates to killing speeds. In a space habitat, a potential assassin may be hard-pressed to find enough space to make his gyrojet pistol useful! Second, most gyrojets will penetrate the wall of a habitat without too much problem. Due to all of these factors, you can most reasonably expect to find gyrojets being used only outside habitats, or inside very, very large habitats like the Crystal Palace or the Lunar colonies. Also, any gyrojet round will leave a heat trail that can easily be followed back to the firer by a Thermograph. See relevant weapon entries for further details. [*Deep Space*]

### **Micromissiles: 50eb each, 75eb for Anti-Armor, 200eb for HEP**

These miniature missiles are explosive-tipped rocket-propelled rounds with heat-seeking guidance and steering vents. They can be programmed to track objects by their specific IR signature (vehicle engines and human body heat are the most common choices), and explode on impact. The missiles are self-guided, and once locked onto a target they can follow it through one direction change of 90 degrees or less, giving them the ability to track around corners and obstacles (with a 3 in 10 chance of losing the target). Attacks are resolved in the following manner: The firer makes an attack roll, adding the Missile's +2 accuracy and ignoring cover and line of sight modifiers. If the attack roll is greater than the difficulty for the listed range, then the missile has hit its target. If the attack fails, then the firer rolls 1D10: On a 4-10, the Micromissile corrects its path and a second attack roll, just like the first, can be made. A failed roll means that the micromissile was distracted and struck something or someone else at random, with no possibility to hit the target (use the Grenade Table on page 89 of *Cyberpunk 2020* to determine where the missile went). However, if your first shot misses your target, you may always fire at him again with your next shot(s)—even if he's under complete cover! Micromissiles have a minimum range of 10 meters, and they must be aimed at a partially exposed target — if they are fired blindly they will fail to initialize a target and will fly in straight paths like normal projectiles. Micromissiles normally do 4D6 damage in a 2m radius, but anti-armor Micromissiles (which treat the target's armor as 1/2SP) are available for a 50% increase in price. Missiles can be fitted with HEP warheads for 4x normal price (4D6+4 damage, no radius, effects equal to S&W Model F). [*Chromebook 2*]

### **Urban Technologies Slasher: 75eb shotshell round, 150eb grenade round**

Another lethal toy from the madmen at Urban Technologies! They've come up with an antipersonnel shell (available in 12 or 10-gauge, 25mm, 30mm, and 40mm shells) that strings monowire between two specially weighted slugs. As the slugs travel, they spread apart, pulling the monowire taut and slicing everything that passes between them in half! The slasher delivers a single attack if it hits, doing 4D6 damage at 1/3x armor SP. The only difference is the length of the monowire—the 12/10-gauge has a 1m wire, while larger shells have longer wires (25mm=2m, 30mm=2.5m, 40mm=3m wire). The shell can attack any target in that area, similar to a shotgun blast. The shotgun version is -3 to WA and has a Long Range of 10m. If the round hits a leg, there is a 50% chance it will wrap both legs, doing separate damage to each leg and immobilizing the target until he cuts the wire. The grenade-launcher version is -2 to WA, and has a Long Range of 50m. The round has a 75% chance of wrapping the wire around the target automatically (Torso/Arm hit wraps the arms; Leg hit wraps the legs; a Head hit will break the neck 50% of the time). [*Chromebook 2*]



# RECOIL AND THE HEAVY GUNS IN CYBERPUNK 2020

Recoil in *Cyberpunk* is determined primarily by the damage delivered by the weapon. This value is cross-referenced with the size of the weapon, the nature of the ammunition and the rate of fire. All these factors, when calculated together, grant a number (called a **BODY Minimum**) to which the character firing the weapon must compare his BOD stat. If the character's BOD is  $\geq$  his weapon's BOD Min, he may fire it without penalty; if the character's BOD is at least 2 points greater than a semi-auto weapon's BOD Min, he may fire it at an ROF of 2 rather than 1. However, if the firer's BOD is  $<$  the BOD Min, all penalties are based on a number equal to the firer's BOD minus the weapon's BOD Min (referred to as the "D-fac", or **Difference Factor**).

Recoil penalties are as follows: If the firer's BOD is  $<$  his weapon's BOD Min, he may only fire the weapon at an ROF of 1/2, with WA reduced by -2 per 1 point of D-fac, and must make a (BOD+Strength Feat+1D10) roll vs. the (BOD Min x2). If this roll is failed, the firer takes 1 point of damage per point of D-fac to his firing arm; critical failure means that the weapon is also dropped.

**Example:** Sid has a BOD of 8, and is packing a Denby 7710 "Ox-Dropper" revolver (.477 caliber, 5D6 damage). 5(max damage 30/6) x2(handgun) = 10, so Sid's "D-fac" is 2; he can fire the gun once every other turn, at -4 WA, and may take 2 points of damage to his hand from shooting the damn thing!

Remember, recoil is a one-time calculation—once you've determined a weapon's BOD Min, make a note of it somewhere. In order to prevent complications. Any weapon with a BOD Min of 9 or less is assumed to be fireable by anyone (don't worry, all you BOD 6 characters can still fire your Colt-AMT M2000's). If the players and refs wish, they may use the BOD Min restrictions for all weapons, including those of less than 10. Choose your weapons carefully!

Weapon Type	Base BOD Min
D6 weapons	(Max Damage/6)
D10 weapons	(Max Damage/5)
Shotguns	Max SHOT Damage x0.25
Grenade launchers	(Diameter in mm) x0.3

Modifiers	Multiply all mods together
1-handed (handgun)	x2.0
2-handed, no brace* (some SMGs and shotguns)	x1.0
2-handed & brace* (rifles, MGs, other SMGs/shotguns)	x0.5
High-pressure/high-velocity grenades (for auto-GLs)	x1.5
EAP (railguns)	x1.8
ROF 1-3 (semiauto)	x1.0
ROF 3-16	x1.75
ROF 16-30	x2.0
ROF 31-60	x2.5
ROF 61-120	x3.0
ROF 121+	x3.5

\*Brace = Stock, Arm Brace, Shoulder Strap, Harness, Sling, Mono-/Bi-/Tripod, Gyro-Mount, etc.

A Cyberarm acts as BOD 12 for pistol recoil purposes only.

A Powered Exo-Mount has BOD 18 for recoil purposes only.

Example Weapon (ROF)	BOD Min
• Pocket Tsunami 25mm HiVel Pistol (ROF 2)	Min BOD 23!
• 12.7mm Gatling w/harness (ROF 100)	Min BOD 18.
• MK19 40mm HiVel AGL (ROF 3 or 20)	Min BOD 16-18.
• ASP 30mm Autocannon w/harness (ROF 10)	Min BOD 16.
• HIVE Gatling w/harness (ROF 120); 10-gauge "Pistol"/5D6 (ROF 2)	Min BOD 15.
• ASP 20mm w/harness (ROF 10)	Min BOD 14.
• 12-gauge Pistol (ROF 2); Malorian 3516 and ACPA 14mm Pistol (ROF 1)	Min BOD 12.
• Plamya 30mm AGL (ROF 1 or 10)	Min BOD 7-12.
• Browning .50 M2 (ROF 10-20)	Min BOD 11-12.
• EMG-85 Railgun (ROF 1/2)	Min BOD 11.
• Minigun (ROF 100-200)	Min BOD 10-11.
• Tsunami 25mm AGL (ROF 1/3/5)	Min BOD 10.
• Militech Crusher SSG; Super Chief .454 Casull	Min BOD 9.





# BANG!

## YOU'RE DEAD.

Unless you stay hip with what's out there on the street being pointed at you, the next donor at the body banks is likely to be you.

In this, the definitive guide to street weaponry, noted Solo Morgan Blackhand has compiled statistics and information on every knife, pistol, submachine gun, bullet, grenade, and piece of personal artillery available in 2020. Prices, damage capability, availability—it's all in here. Plus, it's packed with illustrations so you'll know whether that Boosterganger is pointing a peashooter or a hand cannon at you.

This sourcebook for *Cyberpunk*<sup>®</sup> contains every weapon to ever appear in a supplement or sourcebook to date, from the devastating cyborg weapons in *Solo of Fortune 2* to the Rhinemetall Railgun from *Chromebook 2*. Plus—one new gun; an innovative new design that players will love. Gunheads take note—if it has the potential to make things scream and bleed, it's in this book. Don't be caught in a dark alley without it.



Copyright 1995 R. Talsorian Games All Rights Reserved. Cyberpunk<sup>®</sup> is R. Talsorian's trademark name for its game of the dark future. *Blackhand's Street Weapons 2020* is a trademark of R. Talsorian Games Inc. All Rights Reserved. All incidents, situations, and persons portrayed within are fictional and any similarity, without satiric intent, to characters living or dead is strictly coincidental.

**CP3461 • ISBN# 0-937279-75-7**

**CYBERPUNK**

A CYBERPUNK<sup>®</sup> SOURCEBOOK

R. TALSORIAN  
GAMES, INC.