

DEPARTMENT OF THE ARMY

***OPERATOR'S
MANUAL FOR***



**AK-47
ASSAULT RIFLE**



PRODUCED BY 203d MILITARY INTELLIGENCE BATTALION

TABLE OF CONTENTS

	<u>PAGE</u>
SECTION I. GENERAL	2
SECTION II. TECHNICAL DATA	2
SECTION III. OPERATION	5
SECTION IV. DISASSEMBLY	14
SECTION V. ASSEMBLY	23
SECTION VI. ACCESSORIES	31
SECTION VII. MAINTENANCE	38
SECTION VIII. AMMUNITION (BALL & BLANK)	39

AK-47: SAFETY CHAPTER

LOADING

A. Check ammo for dents in cartridges and bad primers.

B. When inserting magazine into magazine well, be sure to insert forward lip of magazine into well first. Be sure that magazine is fully seated.

FIRING

A. Pull charging handle, shown on page 11 figure 16, fully to the rear and release.

NOTE: DO NOT RIDE CHARGING HANDLE FORWARD:

B. When on the firing line, keep your weapon up and pointed down range at all times. If you have a malfunction, raise your hand and range personnel will aid you.

CAUTION: Only blank ammunition may be fired when the blank firing device is in place. Do not use the cap of the combination tool kit as a blank firing device.

HAND GRENADE LAUNCHER: The hand grenade launcher is installed by removing the muzzle nut (fig. 53) and screwing the launcher onto the weapon (fig. 54).

TO FIRE THE GRENADE: Insert a grenade with the pin pulled into the launcher.

CAUTION: A special type cartridge is used for firing the grenade. Place the butt of the weapon on the ground and fire from this position. The maximum effective range the grenade can be fired is 250 meters.

THE BAYONET: (fig. 55) is affixed by positioning its loops in front of the muzzle nut and gas cylinder body and sliding the bayonet to the rear until the bayonet catch engages the muzzle nut (fig. 56). The bayonet is removed by pulling the catch, located behind the hilt, away from the handle and sliding the bayonet forward and off.

PLASTIC MAGAZINE: The Soviet AK-47 metal magazine is gradually being replaced by the plastic magazine, (fig. 57), which is lighter than the metal. The plastic magazine, because it is lightweight and waterproof, is used mainly by marines, airborne, and armor units.

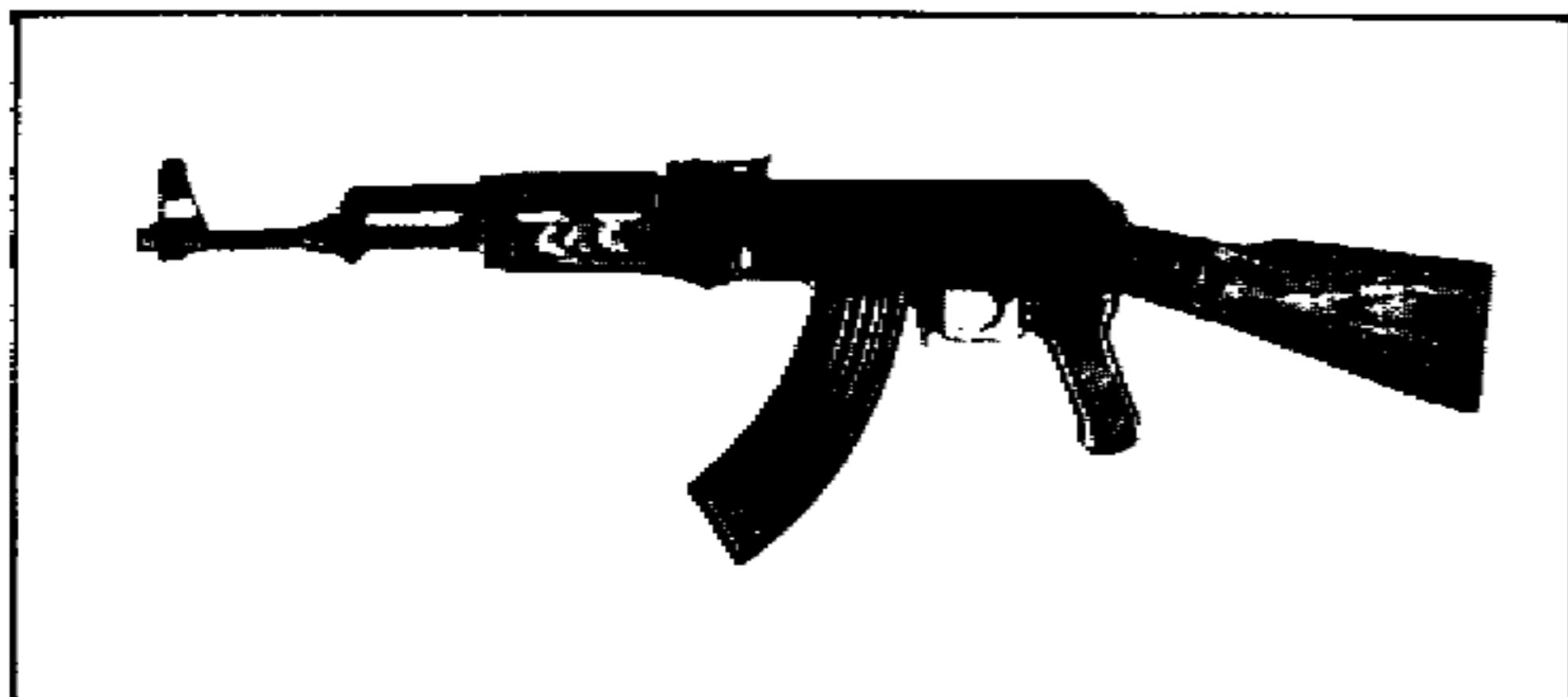

FIGURE 1. LEFT VIEW, AK-47



FIGURE 2. RIGHT VIEW, AK-47

SECTION I. GENERAL

The AK-47 (fig 3) is a short, compact, selective-fired weapon designed by the Soviets in 1946 which fires a cartridge intermediate in power between submachine gun and rifle cartridges. It has a mild recoil which gives it the capability of delivering effective full automatic fire up to 300 meters.

In addition to the Soviet Union, the People's Republic of China, East Germany, Poland, Bulgaria, Romania, North Korea, Hungary, and Yugoslavia have manufactured the AK-47. The selector markings on the right side of the receiver provide a ready means of identifying the country of origin (fig 4).

The AK-47 is produced in two different basic models - one with a conventional fixed wooden stock (fig 5) and the other with a folding metal stock (fig 6). The folding stock is used mostly by airborne and armor units.

SECTION II. TECHNICAL DATA

Cartridge	7.62x39mm
Feed	Magazine (fig 7)
Magazine capacity	30 rds
Gas operated	
Weight	9.5 lb
Length	34.2 in
Length w/folded stock	27.5 in
Rate of fire semiautomatic	40 rpm
Rate of fire automatic	100 rpm
Rate of fire cyclic	600-800 rpm
Maximum effective range	400 meters



FIGURE 3. AK-47

WEAPON MARKINGS

FACTORY	SELECTOR			COUNTRY
	SAFE - UPPER	MID	LOWER	
△ 1954Г		FB	OD	USSR
△ 66 56-1		连	单	PRC
△ 66		L	D	PRC
M22		L	D	PRC
☆ 584		리	E+	N. KOREA
⊙		AB	ED	BULG.
⊙ 1962		C	P	POL.
△ 1966	S	FA	FF	RUM.
☼ 63		D	E	E. GERM.
ДХ 1951Г		FB	OD	USSR
△ 五六五		火		PRC
⊙ 57 △ 51 ☆				PRC
⊙ 37 △ 47				PRC
◇				E. GERM.
△				PRC
△ 216				PRC
☆		ПР	ОГОНЬ	USSR
⊙		ПР	ОГОНЬ	USSR
✂				CZECH
		∞	1	HUNGARY
		FINLAND
		R	J	YUGOSLAVIA
		30	1	CZECH
☼ 63		D	E	E. GERM.
⊙		리	리	N. KOREA
△ 五六五		L	D	PRC

FIGURE 4

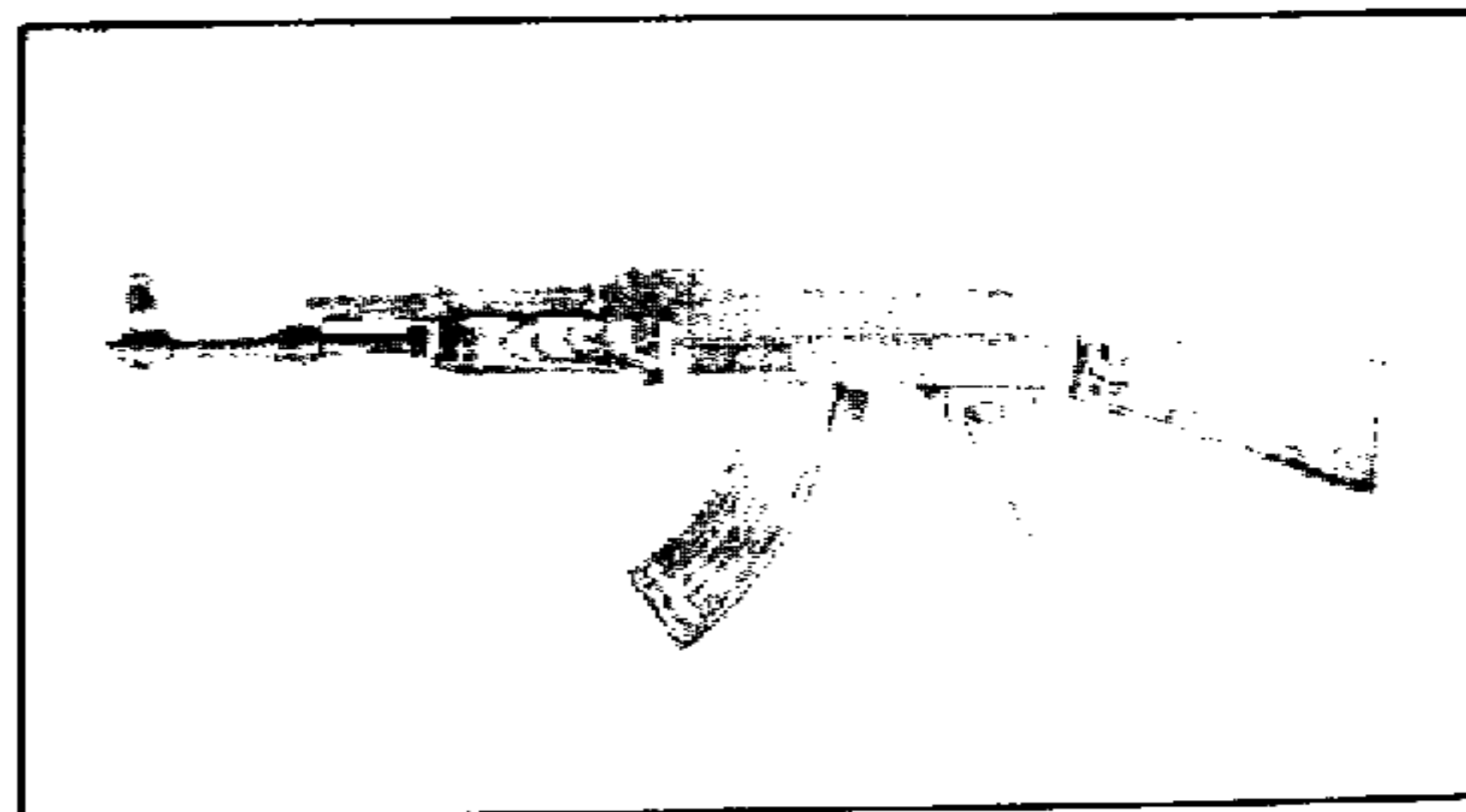

FIGURE 5. WOODEN STOCK



FIGURE 6. FOLDING STOCK

SECTION III. OPERATION

Loading the Magazine: Place a round between the feed lips (fig 8). Press it down until it locks inside the magazine. Repeat until magazine is full (30 rds).

Inserting the magazine into the receiver: Cant the magazine forward so the lug on the front of the magazine engages with its recess in the magazine well (fig 9); then pull the magazine to the rear until it snaps into place.

Loading the AK-47: Pull the operating handle (fig 10), fully to the rear and release it so the lug on the bottom of the bolt can strip a round from the magazine and into the chamber. NOTE: The selector (fig 11), must be in a firing position. CAUTION: Always keep the selector in the safe (upper) position until the weapon is ready to be fired.

Firing the AK-47: Place the selector on the desired position (automatic middle position, and semi-automatic lower position)(fig 12). Aim using a normal sight picture and pull the trigger.

The AK-47 with the metal stock can also be fired with the stock folded. This is done by pressing the stock latch located on the left rear of the receiver (fig 13), swinging the stock down beneath the weapon (fig 14). This position is used mainly by airborne and armor units.

Immediate action: For a runaway gun, keep the rifle pointed up and down range until all ammunition is expended. Clear the weapon and inspect it to determine the cause of the malfunction. Immediate action for a misfire is to keep the rifle pointed down range for at least one minute. Then pull the operating handle to the rear and eject the misfired round. Load a new round and attempt to fire it. If it does not fire, wait one minute and then unload the rifle. Inspect to determine the cause of the malfunction.

Unloading: Remove the magazine by pressing the magazine catch (fig 15) toward the magazine; then swing the magazine forward and out of the receiver. Pull the operating handle fully to the rear, inspect the chamber and receiver. If no cartridge is present, release the operating handle and pull the trigger (fig 16).

Zeroing: Set the rear sight for the desired range by pressing in on the slide catch and moving the slide bar along the leaf until the front edge of the bar is aligned with the line below the number that corresponds with the range in meters (fig 17).

The front sight post can be screwed in or out of its base to adjust for elevation. The wrench in the combination tool kit is used

for this purpose (fig 18). Lateral zeroing is done by moving the cylindrical front sight post mount from side to side using the lateral zeroing tool (fig 19).

If the strike of the bullet is below the control point, the front sight should be screwed in. If above, it should be screwed out. If the strike of the bullet is to the left of the control point, the slide of the front sight should be moved to the left; if to the right, to the right.

Moving the front sight slide to the left, right, up or down 1mm, changes the strike of the bullet 26cm at 100 meters. One full turn on the front sight post moves the strike of the bullet 20cm when firing at 100 meters. Front sight post changes should be verified by a group of four individually aimed shots. After the weapon has been zeroed, the old mark should be removed and a new one written in.

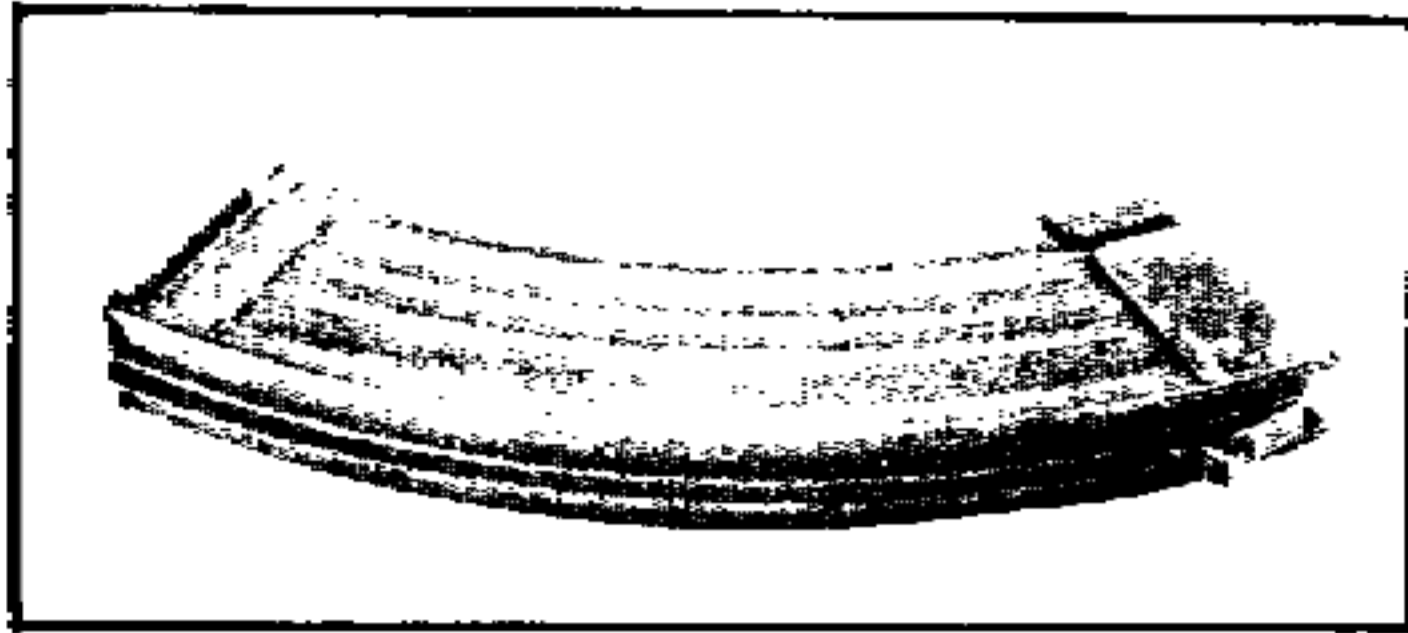

FIGURE 7. AK-47 MAGAZINE

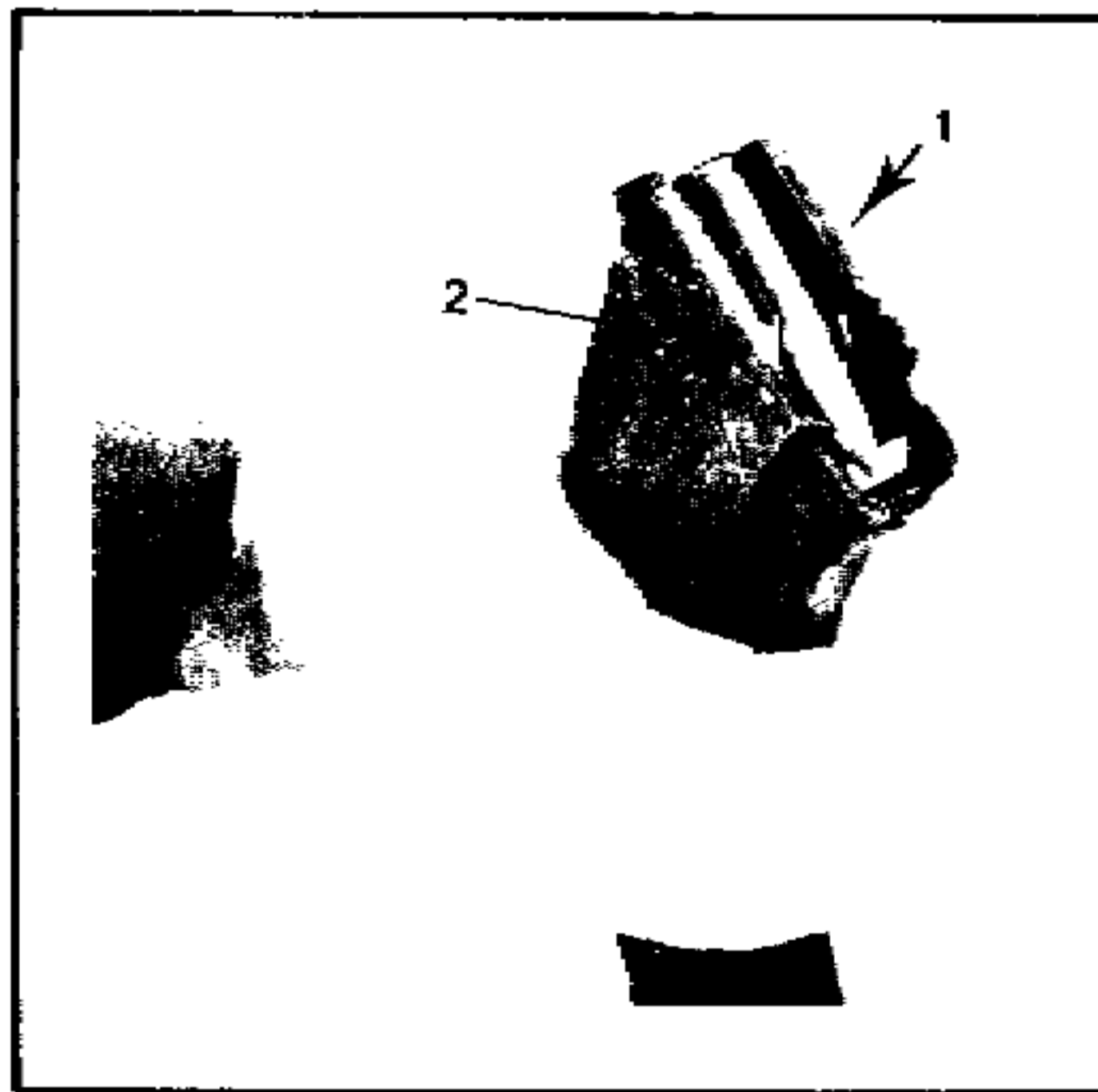

FIGURE 8. LOADING MAGAZINE

1 & 2. FEED LIPS

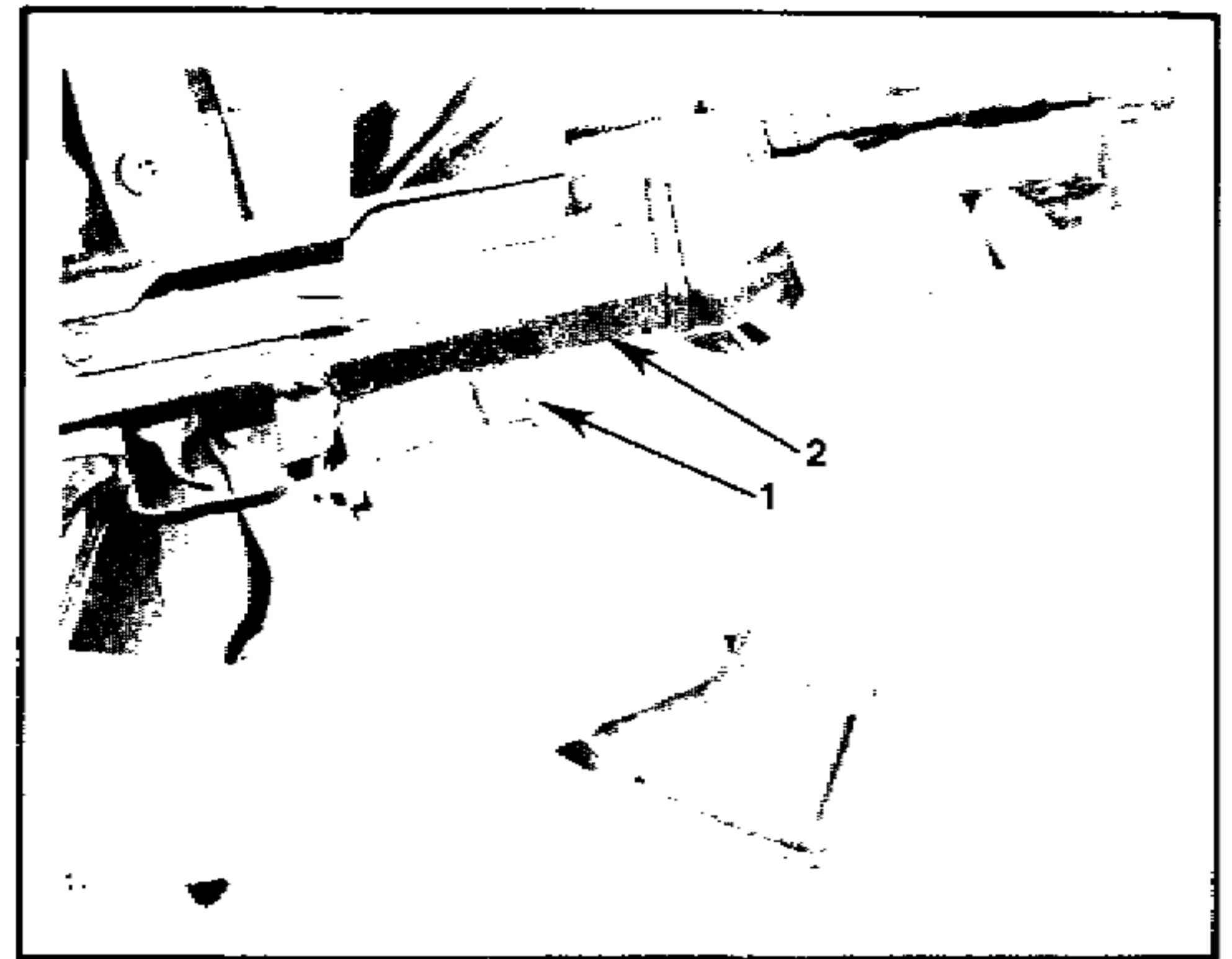

FIGURE 9. INSERTING MAGAZINE

1. MAGAZINE LUG

2. MAGAZINE WELL

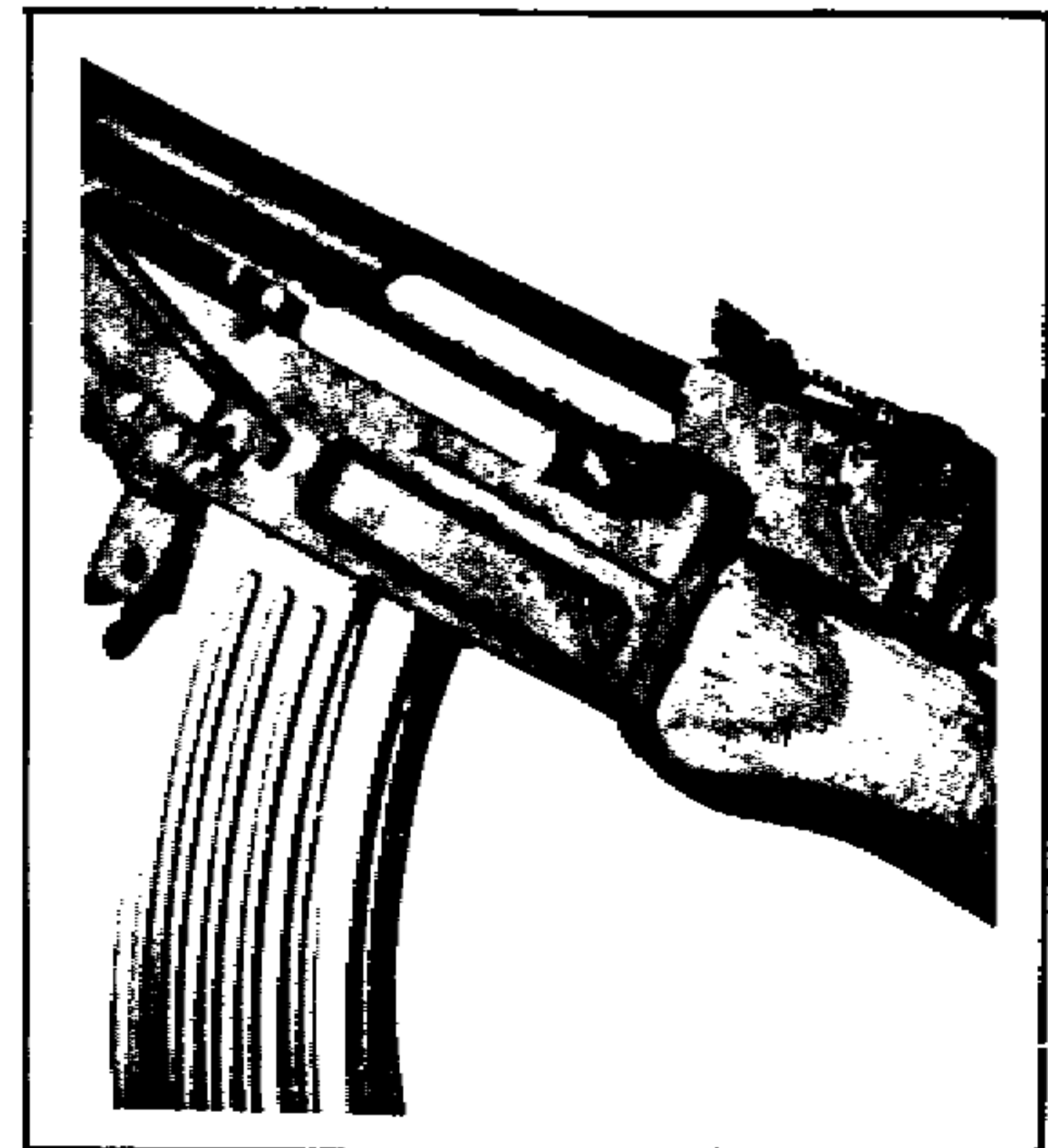

FIGURE 10. OPERATING HANDLE

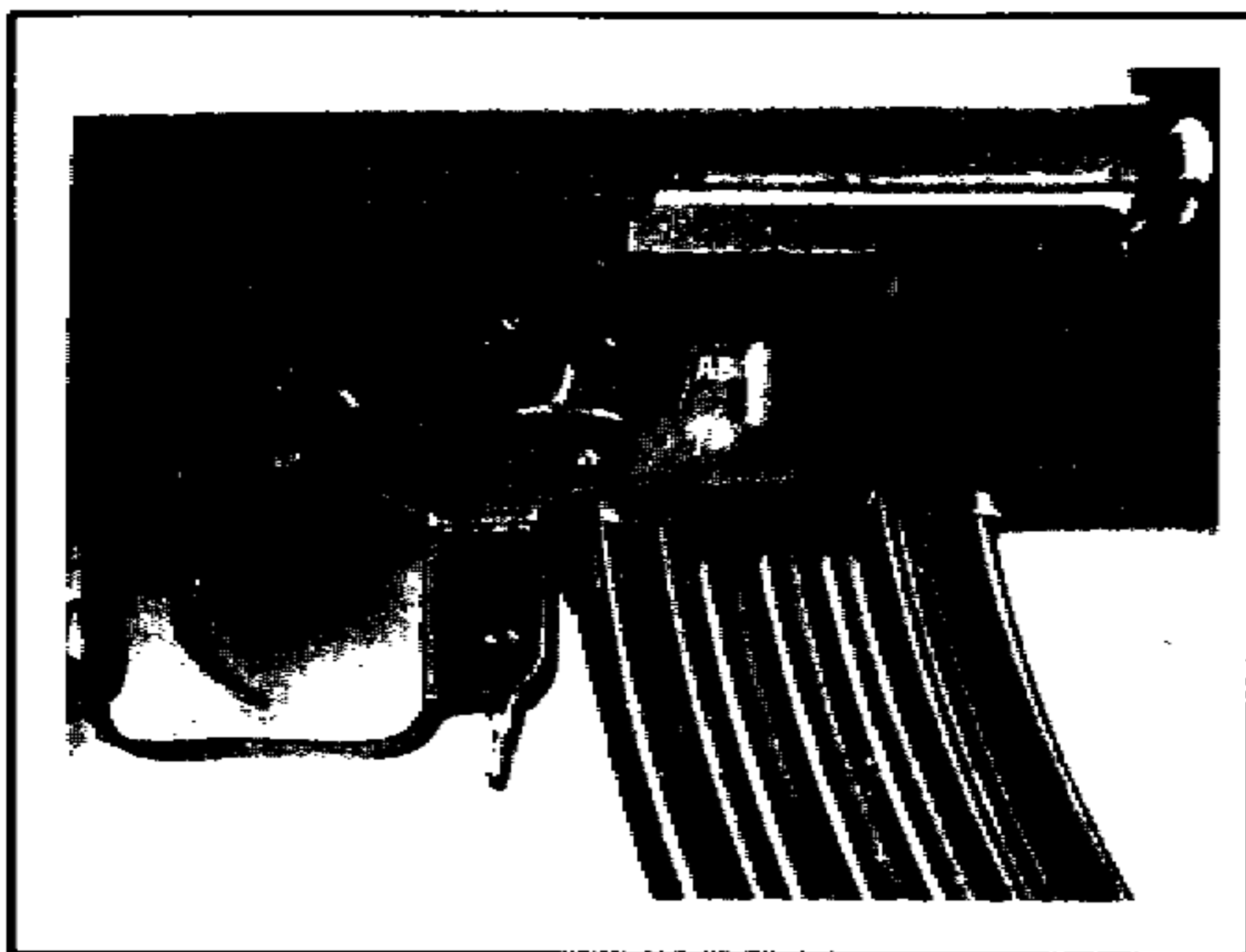

FIGURE 11. SELECTOR IN FIRING POSITION

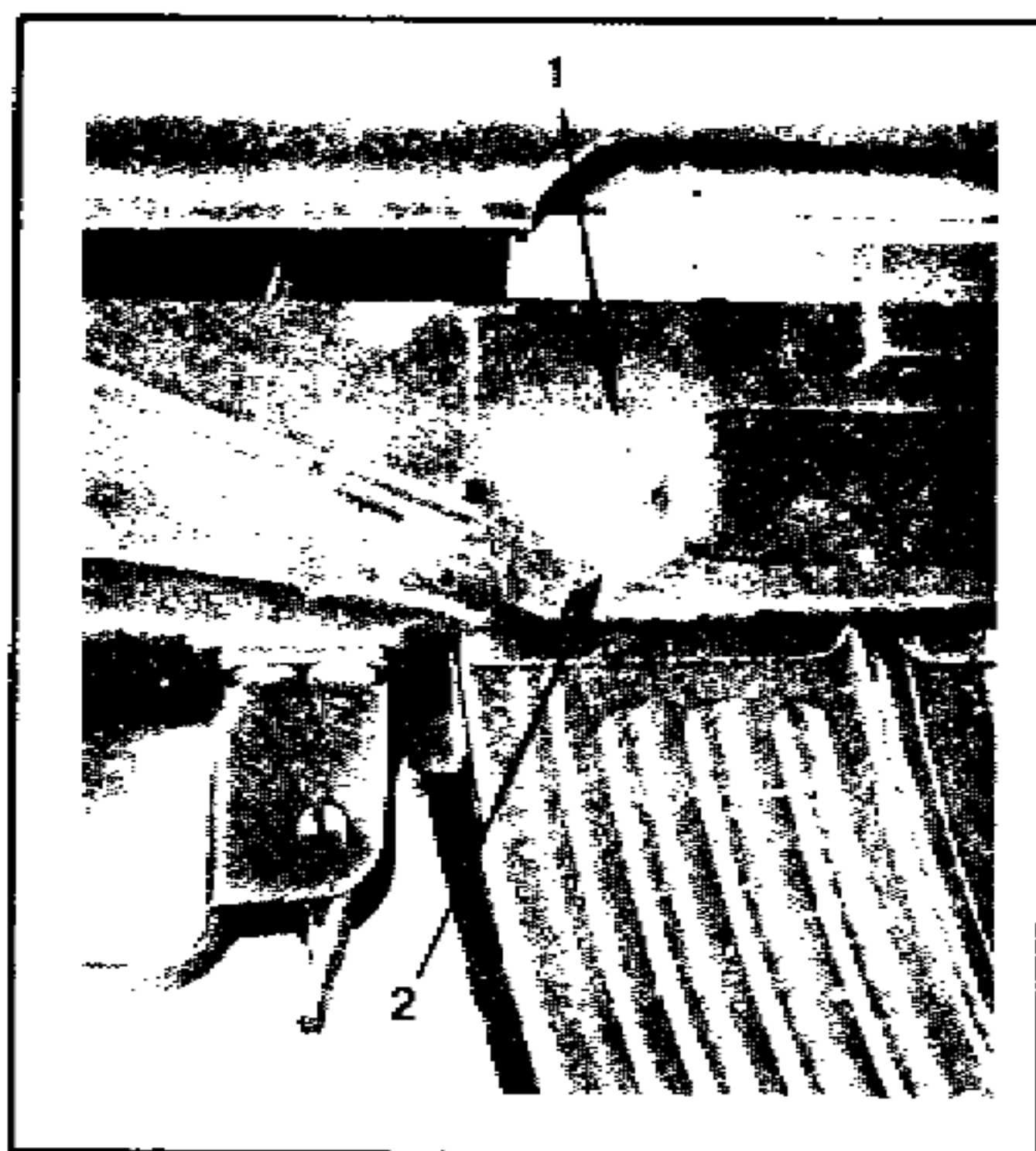

FIGURE 12. SELECTOR IN FIRING POSITION

1. AUTOMATIC
2. SEMIAUTOMATIC

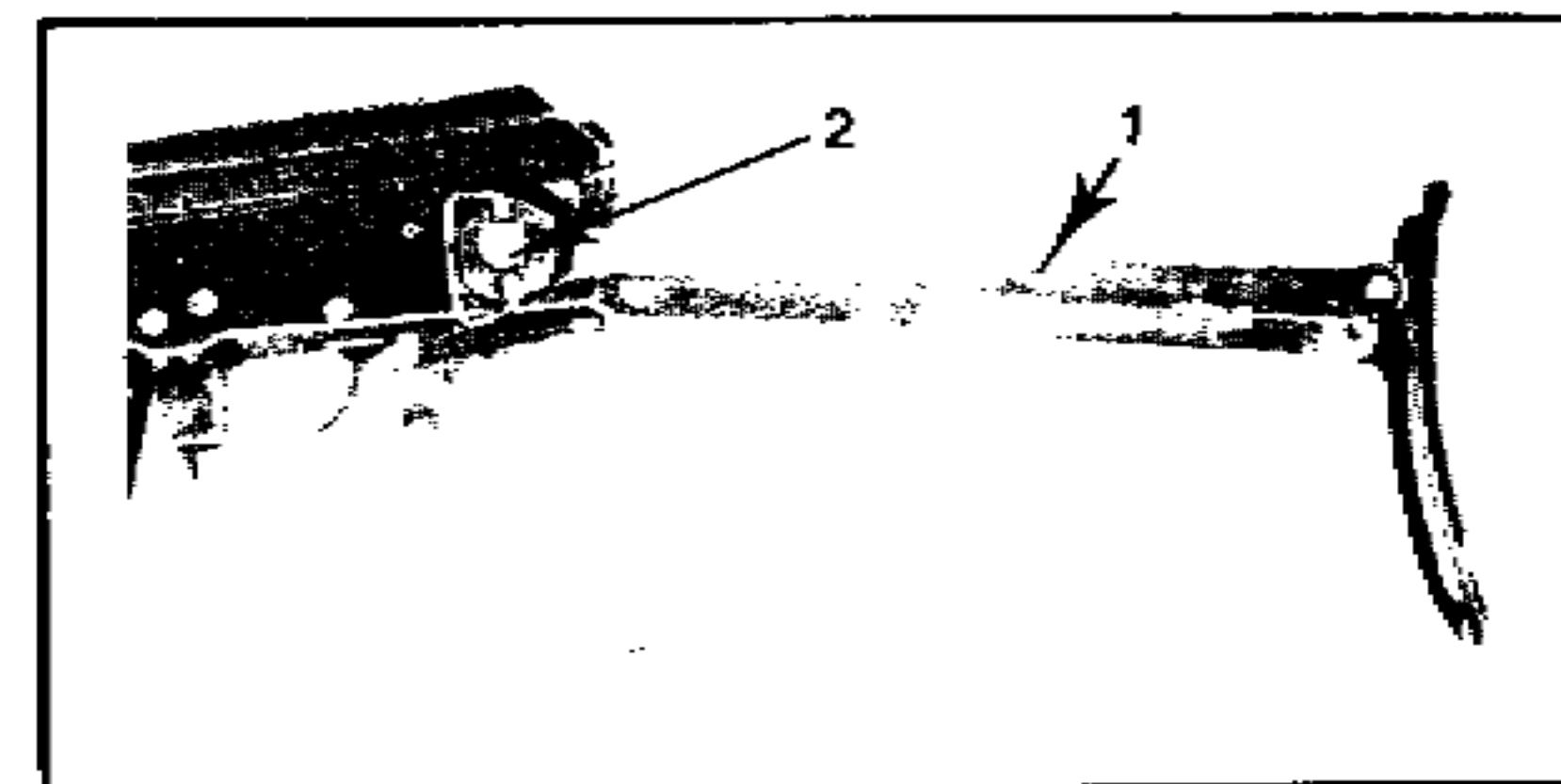

FIGURE 13. FOLDING STOCK

1. STOCK
2. STOCK LATCH



FIGURE 14. STOCK FOLDED

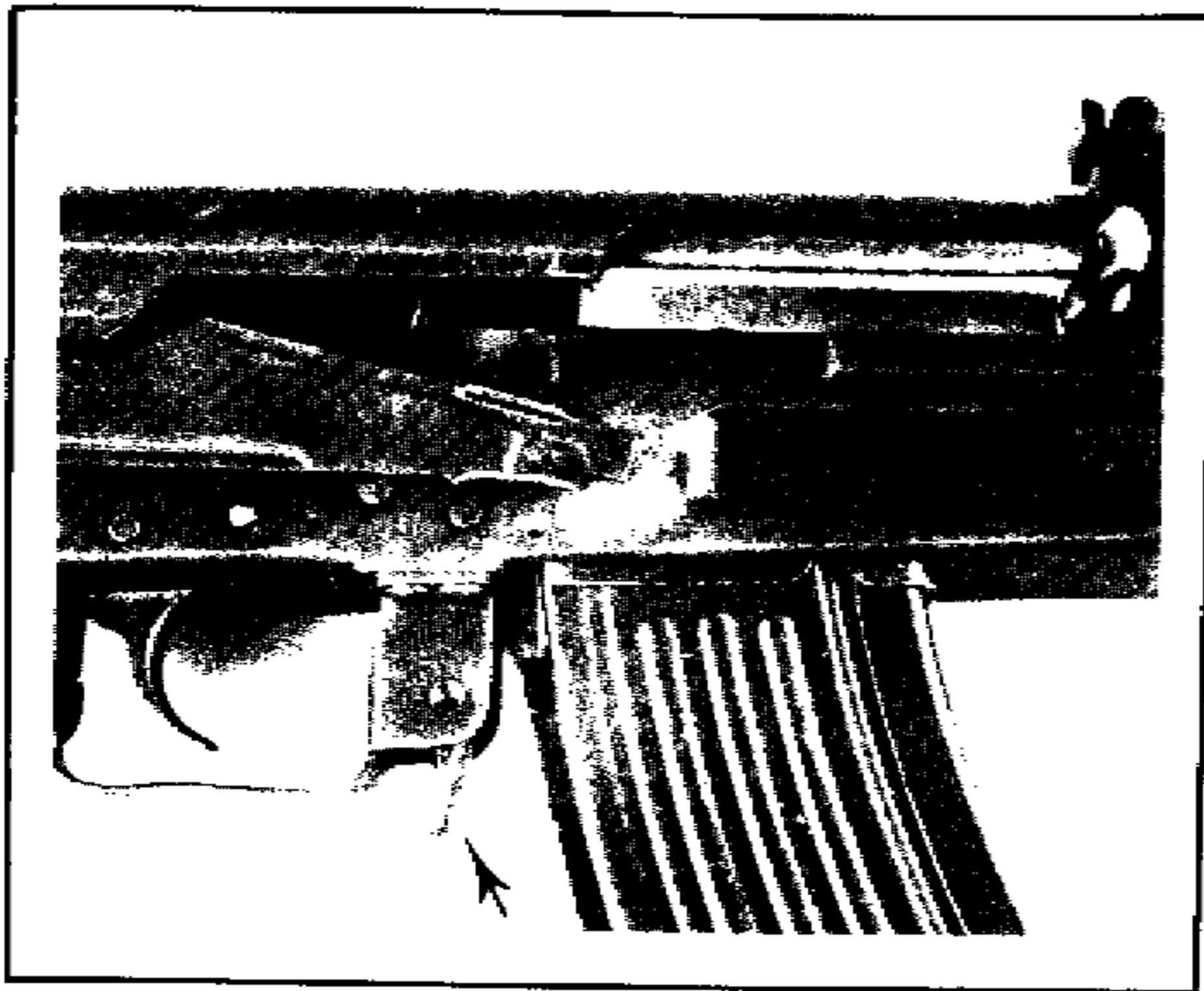

FIGURE 15. MAGAZINE CATCH

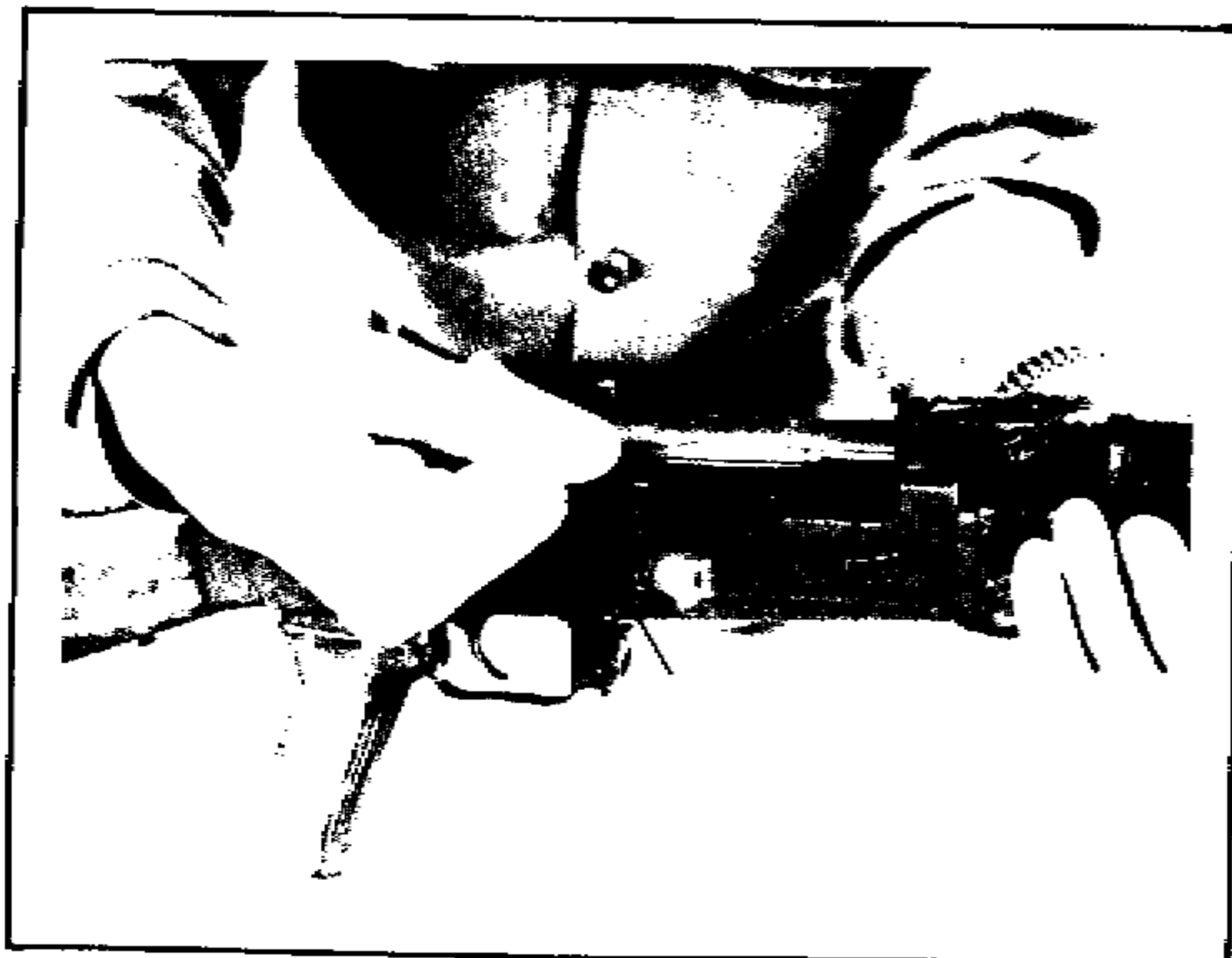

FIGURE 16. OPERATING HANDLE

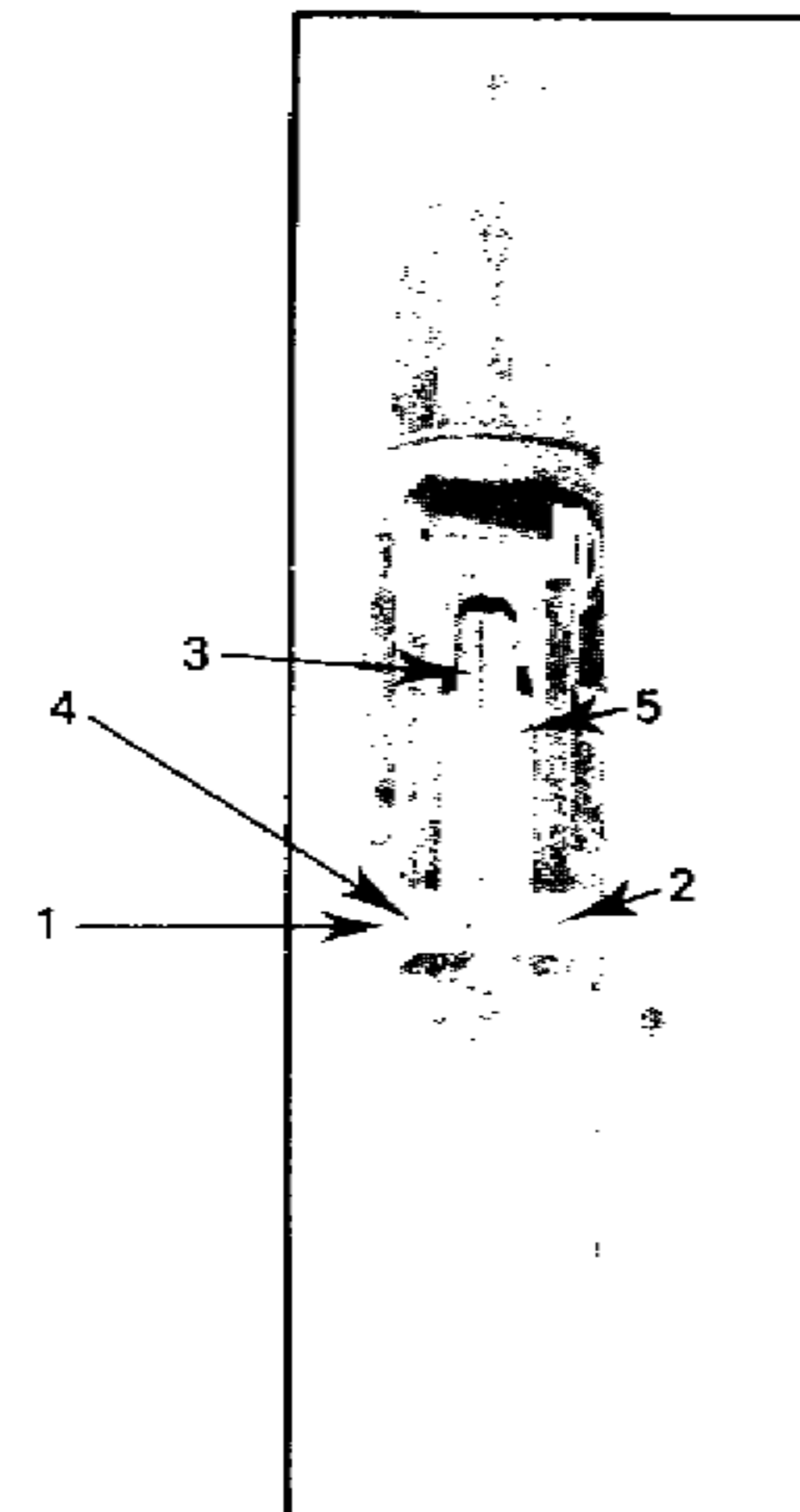

FIGURE 17. REAR SIGHT

1. SLIDE CATCH
2. SLIDE BAR
3. LEAF
4. BAR FRONT EDGE
5. NUMBERS

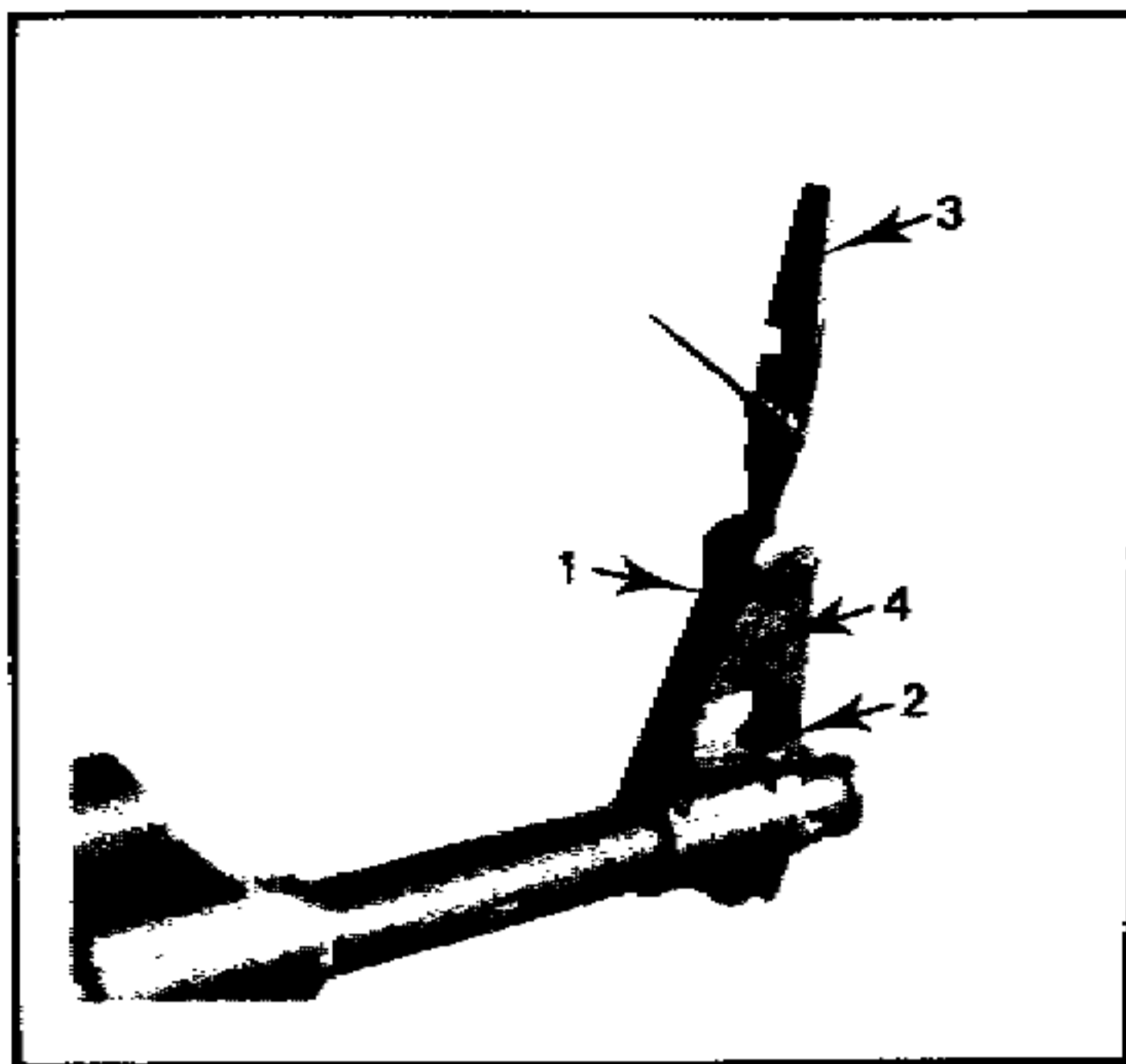

FIGURE 18. FRONT SIGHT

1. FRONT SIGHT POST
2. BASE
3. COMBINATION TOOL
4. CYLINDRICAL POST MOUNT



FIGURE 19. FRONT SIGHT

1. FRONT SIGHT BASE
2. SPECIAL TOOL

SECTION IV. DISASSEMBLY

Unloading and clearing the AK-47: Remove the magazine and pull the operating handle fully to the rear. Inspect the chamber and receiver to insure no cartridges are present. Release the operating handle and pull the trigger (fig 20).

Remove the bolt cover: Press the serrated end of the driving spring guide (fig 21) into the bolt cover, and while holding the guide in, lift off the bolt cover, rear end first (fig 22).

Remove the driving spring assembly: Push forward on the end of the driving spring guide (fig 23), disengaging it from its seat in the rear of the receiver (fig 24); then pull the complete driving spring assembly out of the bolt carrier (fig 25).

Remove bolt and carrier: Pull the operating handle fully to the rear (fig 26), lift the bolt carrier slightly upward (fig 27) and then remove the bolt and carrier by pulling it to the rear (fig 28).

Remove the bolt from the carrier: Press the bolt into the carrier (fig 29) until the bolt operating lug can be twisted free of its cam path in the carrier (fig 30). Pull the bolt straight forward and out of the carrier (fig 31).

Remove gas cylinder tube: Rotate the gas cylinder tube lock upward (fig 32 and 33) to free the gas cylinder tube. Pull up on the rear of the hand guard and remove the tube (fig 34).

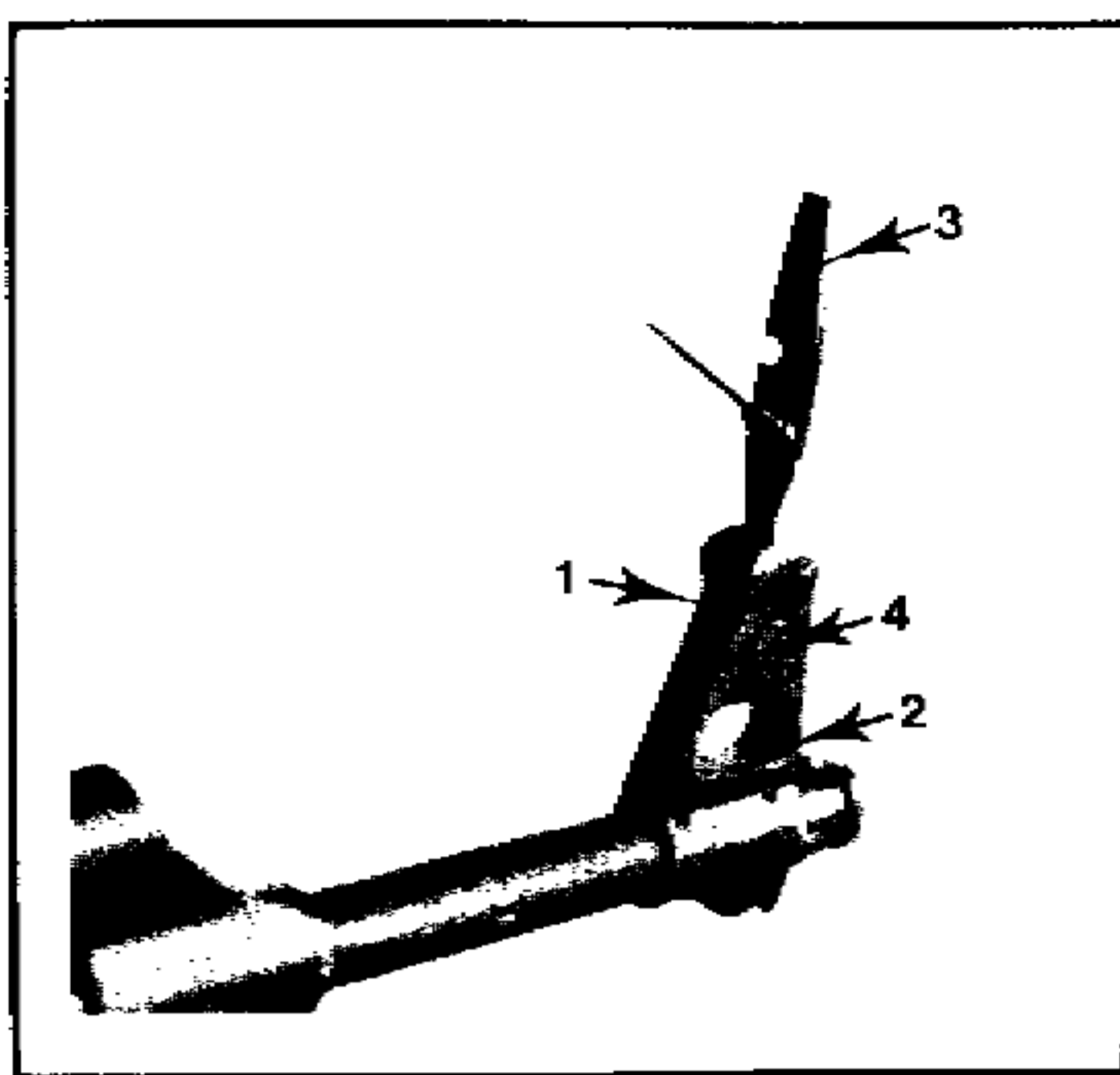

FIGURE 18. FRONT SIGHT

1. FRONT SIGHT POST
2. BASE
3. COMBINATION TOOL
4. CYLINDRICAL POST MOUNT



FIGURE 19. FRONT SIGHT

1. FRONT SIGHT BASE
2. SPECIAL TOOL

SECTION IV. DISASSEMBLY

Unloading and clearing the AK-47: Remove the magazine and pull the operating handle fully to the rear. Inspect the chamber and receiver to insure no cartridges are present. Release the operating handle and pull the trigger (fig 20).

Remove the bolt cover: Press the serrated end of the driving spring guide (fig 21) into the bolt cover, and while holding the guide in, lift off the bolt cover, rear end first (fig 22).

Remove the driving spring assembly: Push forward on the end of the driving spring guide (fig 23), disengaging it from its seat in the rear of the receiver (fig 24); then pull the complete driving spring assembly out of the bolt carrier (fig 25).

Remove bolt and carrier: Pull the operating handle fully to the rear (fig 26), lift the bolt carrier slightly upward (fig 27) and then remove the bolt and carrier by pulling it to the rear (fig 28).

Remove the bolt from the carrier: Press the bolt into the carrier (fig 29) until the bolt operating lug can be twisted free of its cam path in the carrier (fig 30). Pull the bolt straight forward and out of the carrier (fig 31).

Remove gas cylinder tube: Rotate the gas cylinder tube lock upward (fig 32 and 33) to free the gas cylinder tube. Pull up on the rear of the hand guard and remove the tube (fig 34).

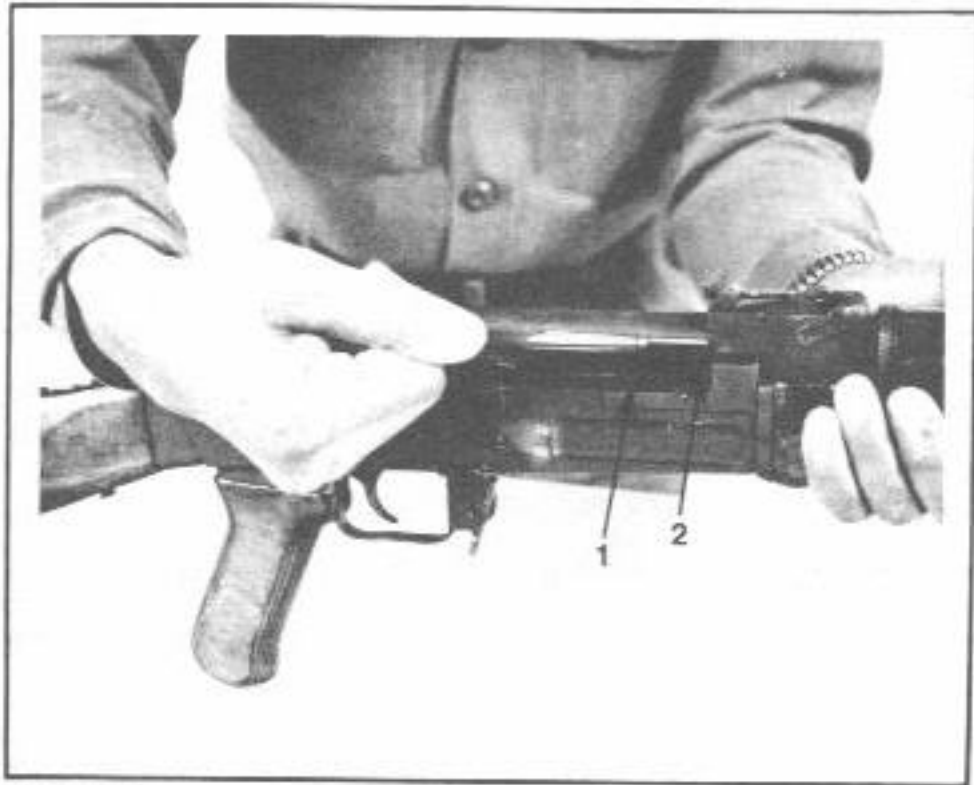

FIGURE 20. CLEARING THE AK-47

1. RECEIVER
2. CHAMBER

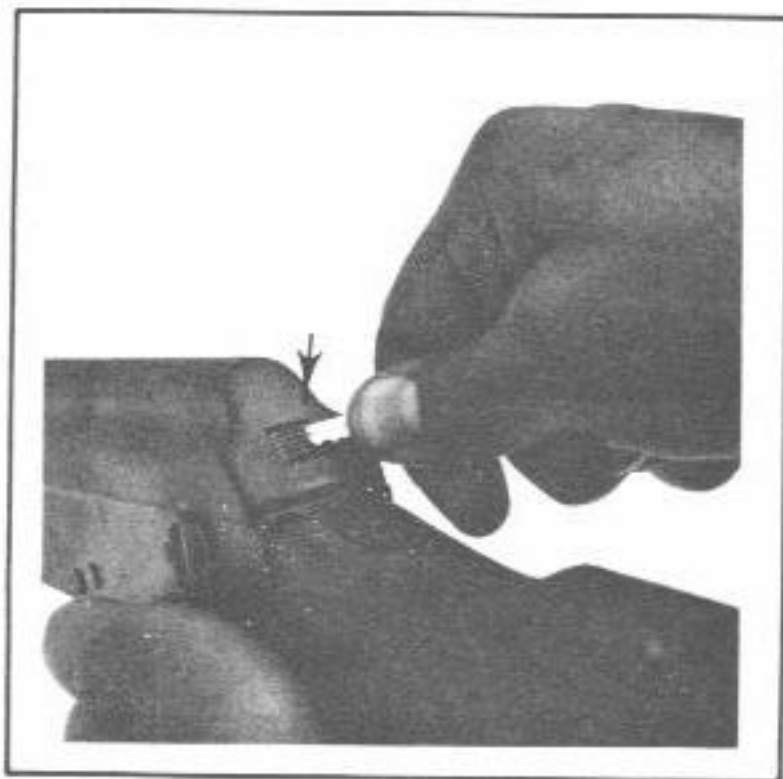

FIGURE 21. DRIVING SPRING GUIDE

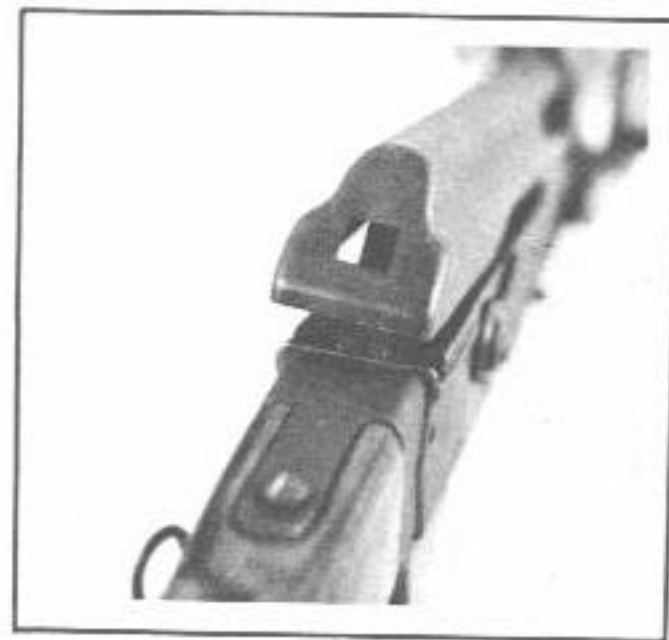

FIGURE 22. REMOVING BOLT COVER



FIGURE 23. DRIVING SPRING

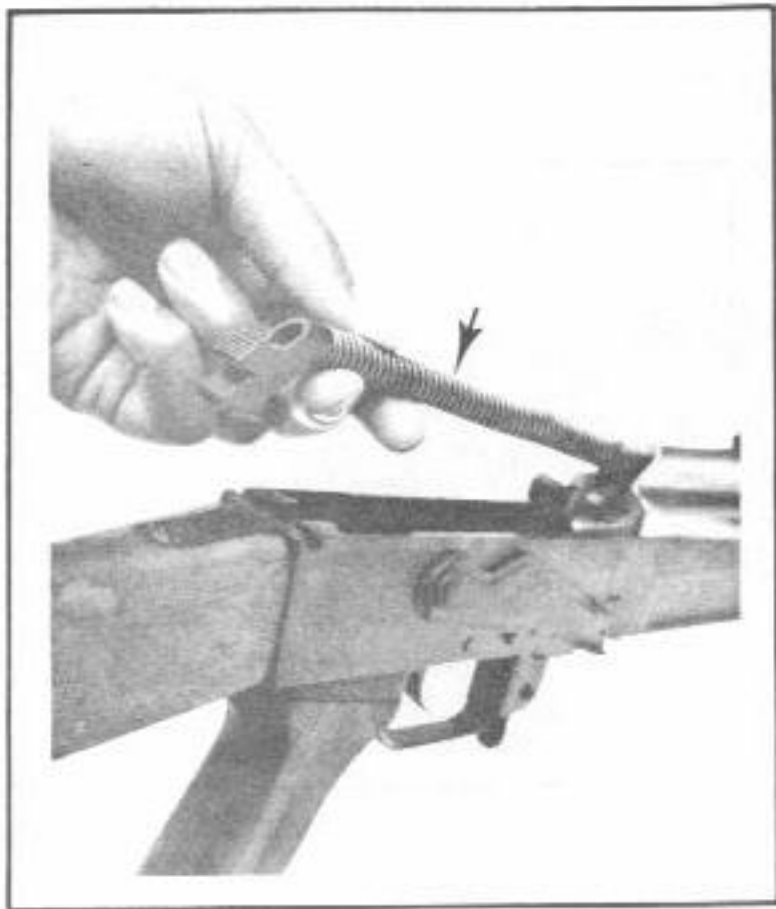

FIGURE 24. DISENGAGING DRIVING SPRING



FIGURE 25. REMOVING DRIVING SPRING ASSEMBLY

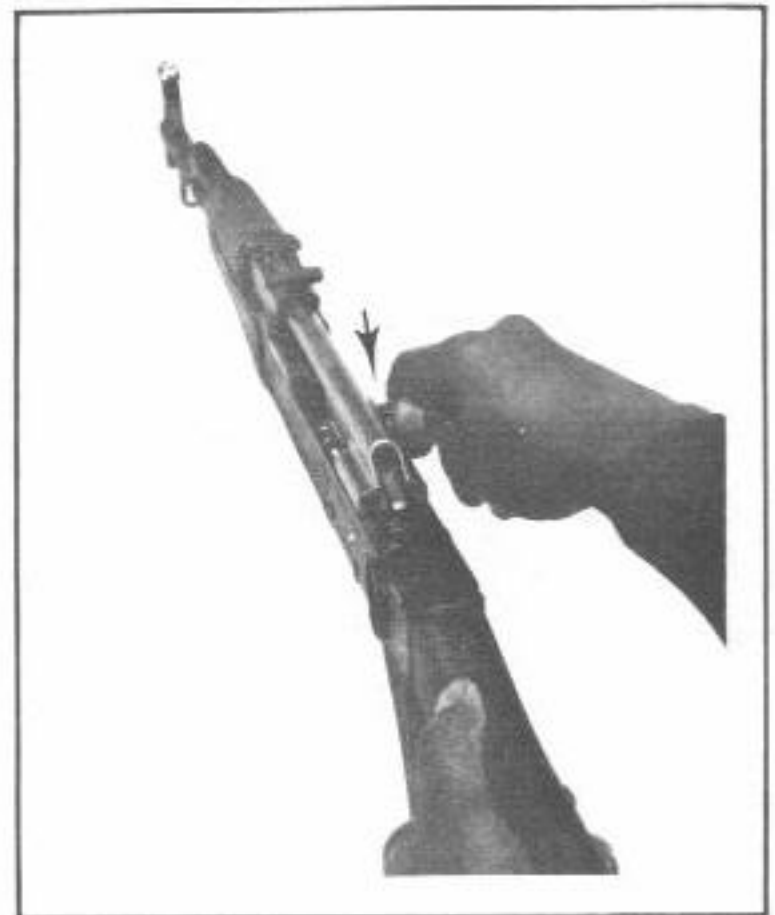

FIGURE 26. OPERATING HANDLE

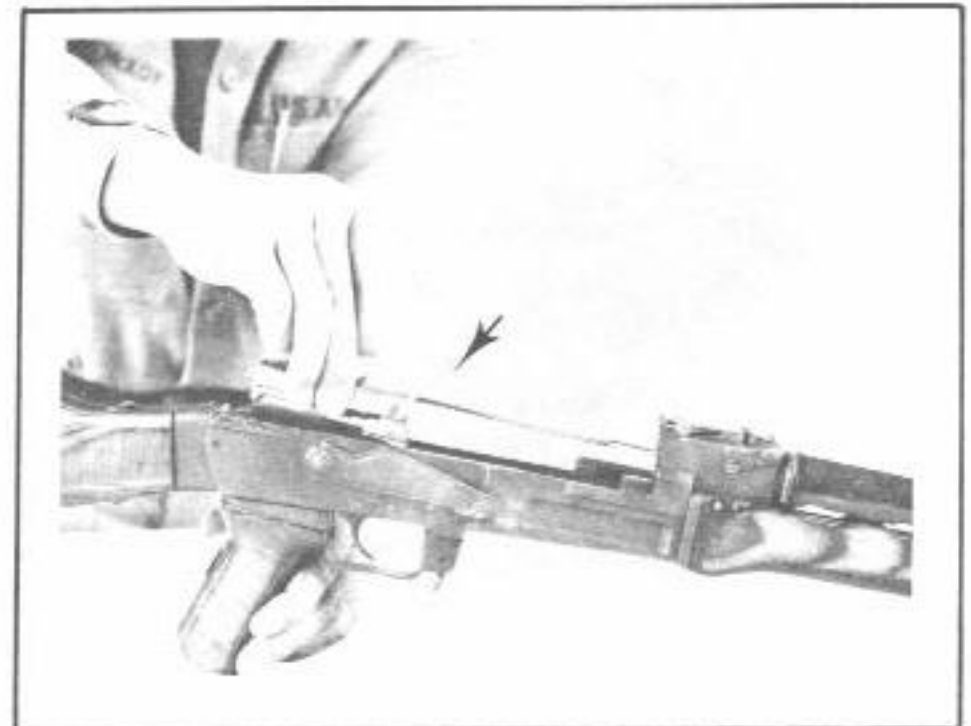

FIGURE 27. LIFTING BOLT CARRIER



FIGURE 28. REMOVING CARRIER



FIGURE 29. REMOVING BOLT



FIGURE 30. OPERATING LUG

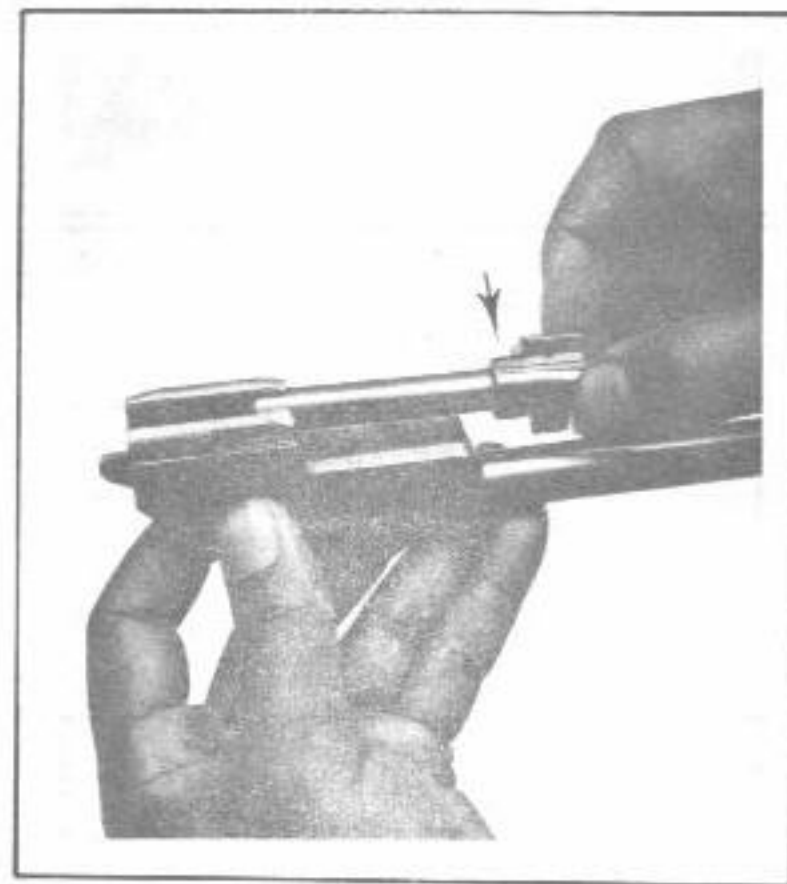

FIGURE 31. REMOVING BOLT

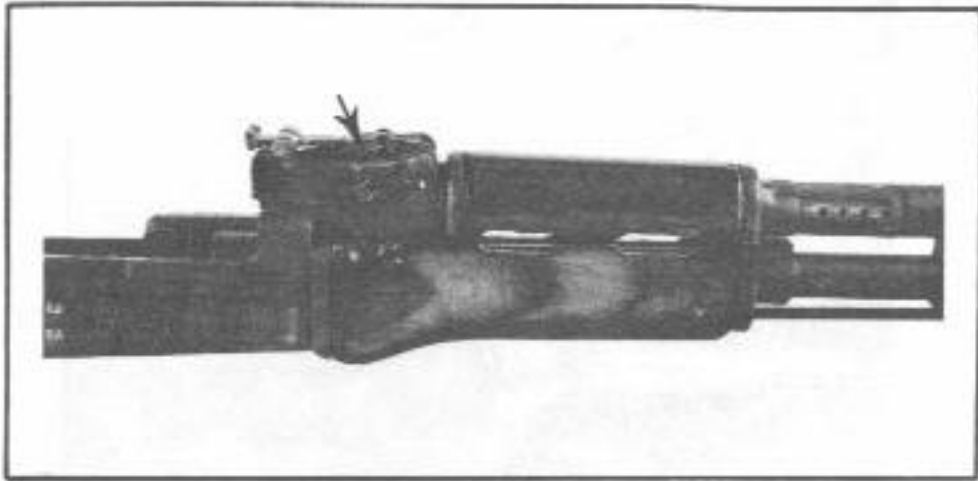

FIGURE 32. TUBE LOCK

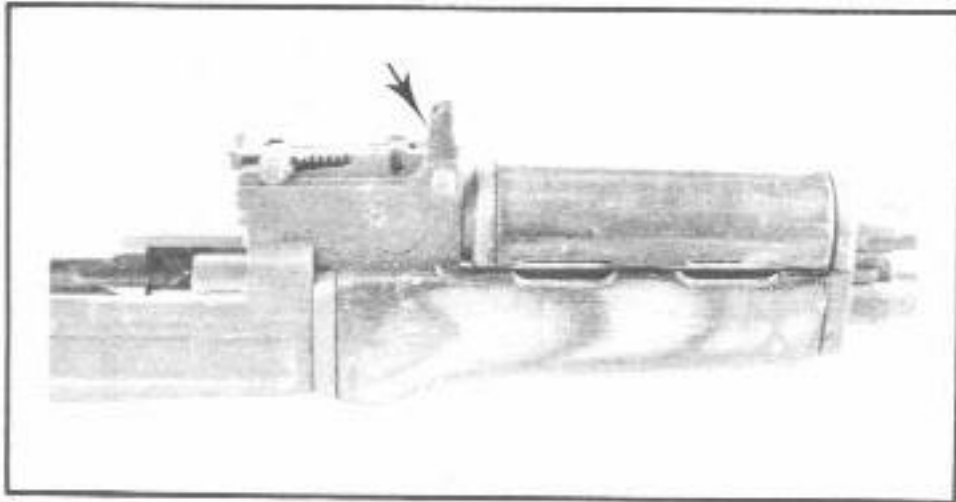

FIGURE 33. TUBE LOCK UPWARD

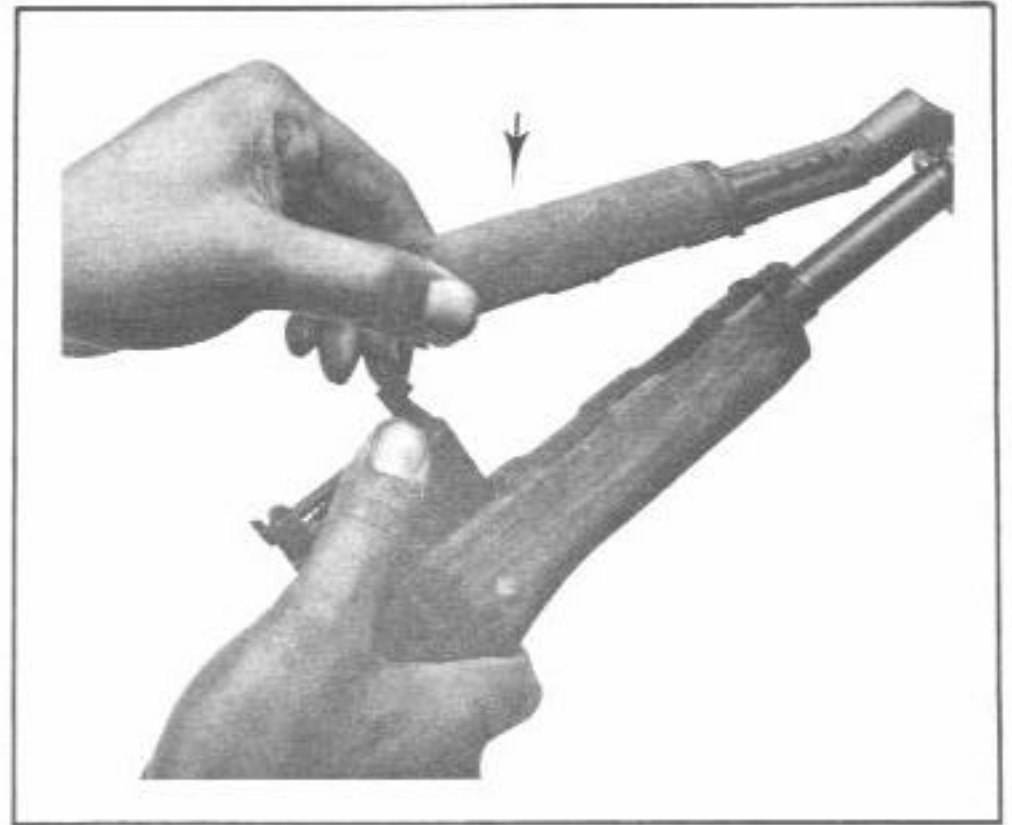

FIGURE 34. REMOVING HAND GUARD

SECTION V. REASSEMBLY

First, engage the front opening of the gas cylinder tube with the gas cylinder (fig 35). Then seat the rear of the tube into the rear sight base (fig 36). Rotate the gas cylinder tube lock down to its lock position (fig 37).

Replace the bolt: Slide the spindle of the bolt into the carrier (fig 38) and rotate the bolt to mate the operating lug with its cam path. Pull the bolt as far forward as possible in carrier (fig 39).

Replace bolt carrier: Slide the piston into the hole under the rear sight (fig 40) until the carrier fits into its cuts at the rear of the receiver (fig 41). Press the carrier down, with the bolt fully forward, and then slide the carrier fully forward (fig 42).

Replace driving spring: Insert the driving spring into its hole in the rear of the carrier (fig 43) and reseat the guide into its slot in the receiver (fig 44).

Replace the bolt cover: Insert the front end of the bolt cover into the circular grooves in the rear sight base (fig 45). Apply thumb pressure over the square hole in the rear of the cover (fig 46); press down and forward until the end of the driving spring guide snaps through the hole (fig 47).



FIGURE 35. ENGAGING TUBE

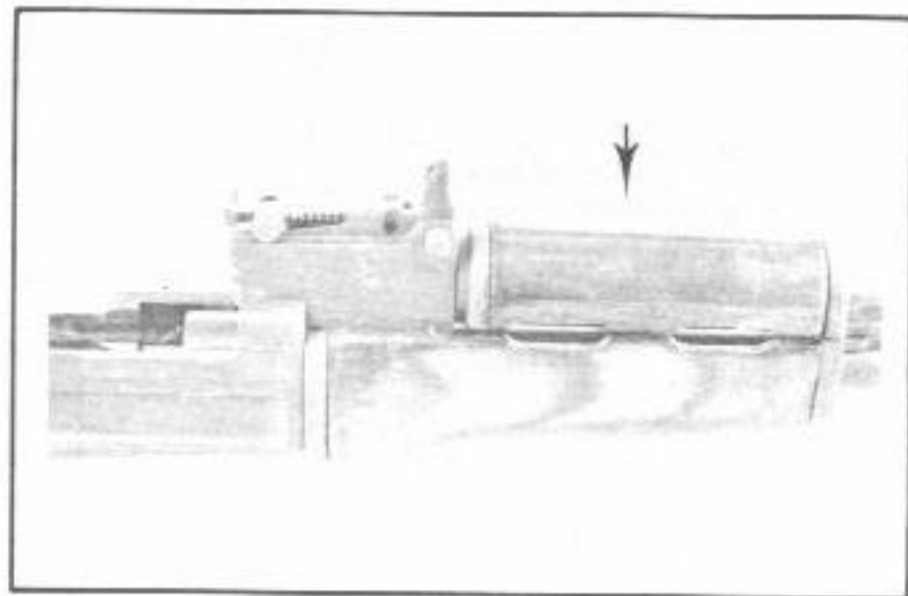

FIGURE 36. TUBE SEATED

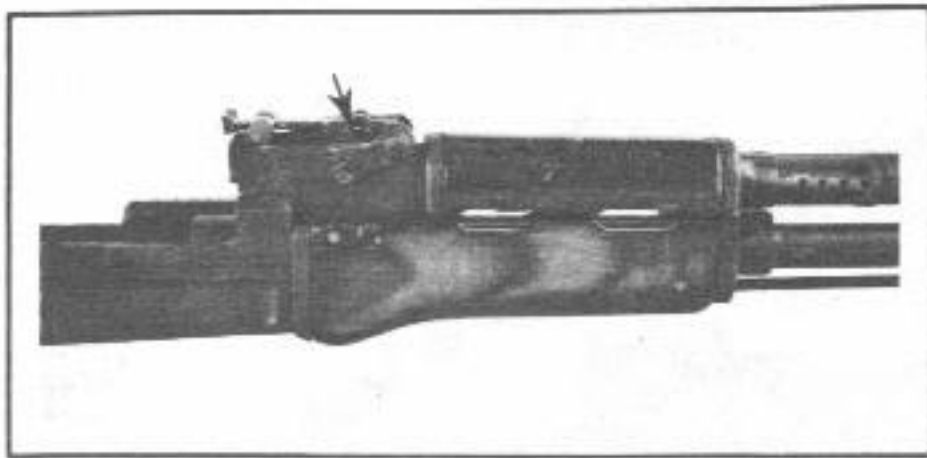

FIGURE 37. GAS CYLINDER TUBE IN LOCK POSITION



FIGURE 38. REPLACING THE BOLT

1. SPINDLE
2. CARRIER

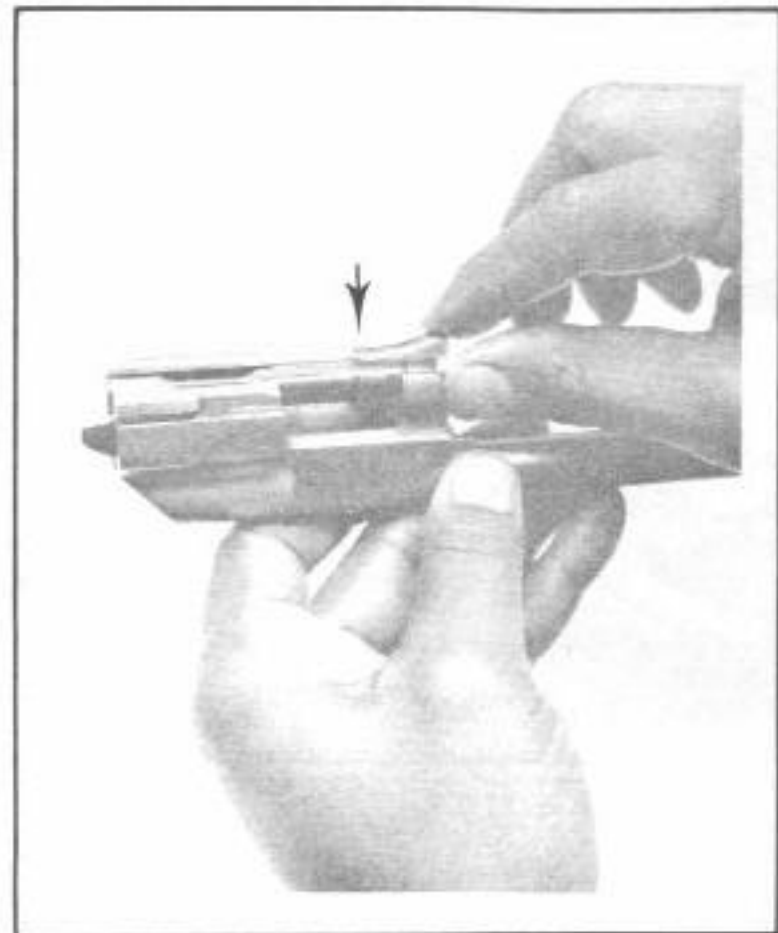

FIGURE 39. BOLT IN CARRIER

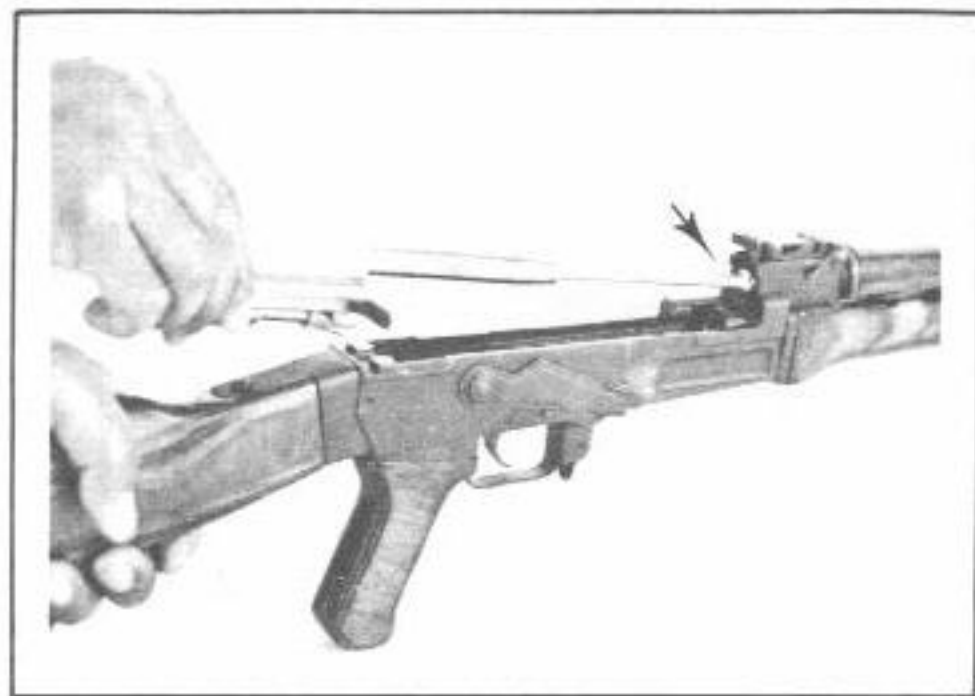

FIGURE 40. REPLACING BOLT CARRIER



FIGURE 41. CUT IN RECEIVER



FIGURE 43. REPLACING DRIVING SPRING



FIGURE 42. CARRIER SEATED

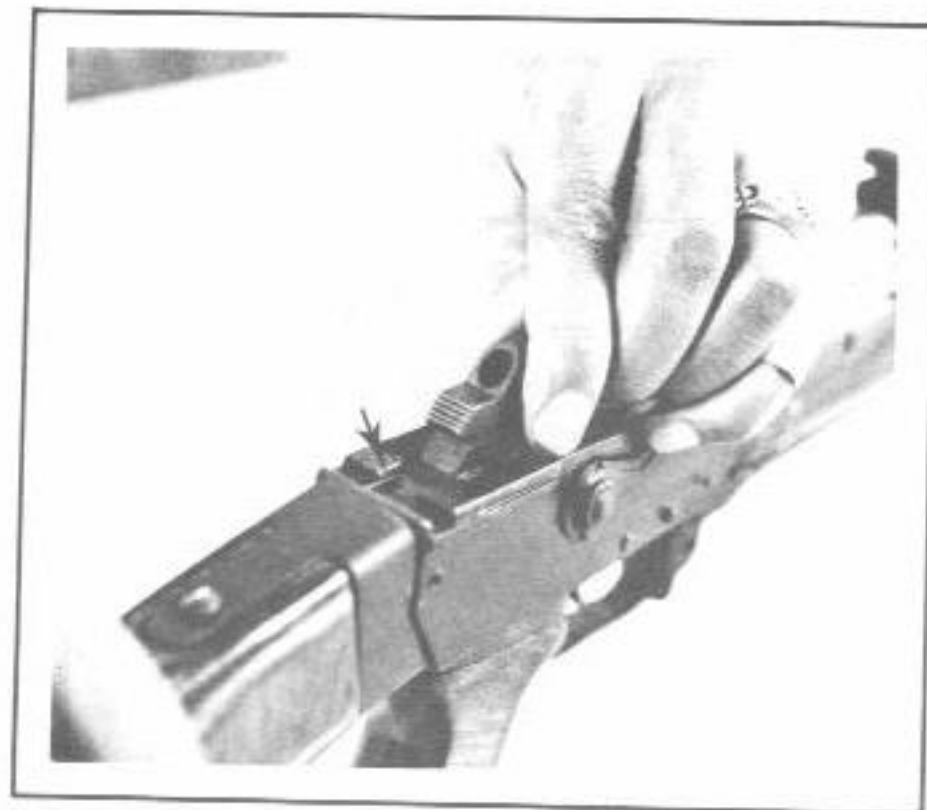

FIGURE 44. DRIVING SPRING GUIDE SLOT



FIGURE 45. REPLACING BOLT COVER

1. FRONT OF COVER
2. CIRCULAR GROOVE



FIGURE 46. HOLE IN REAR OF COVER

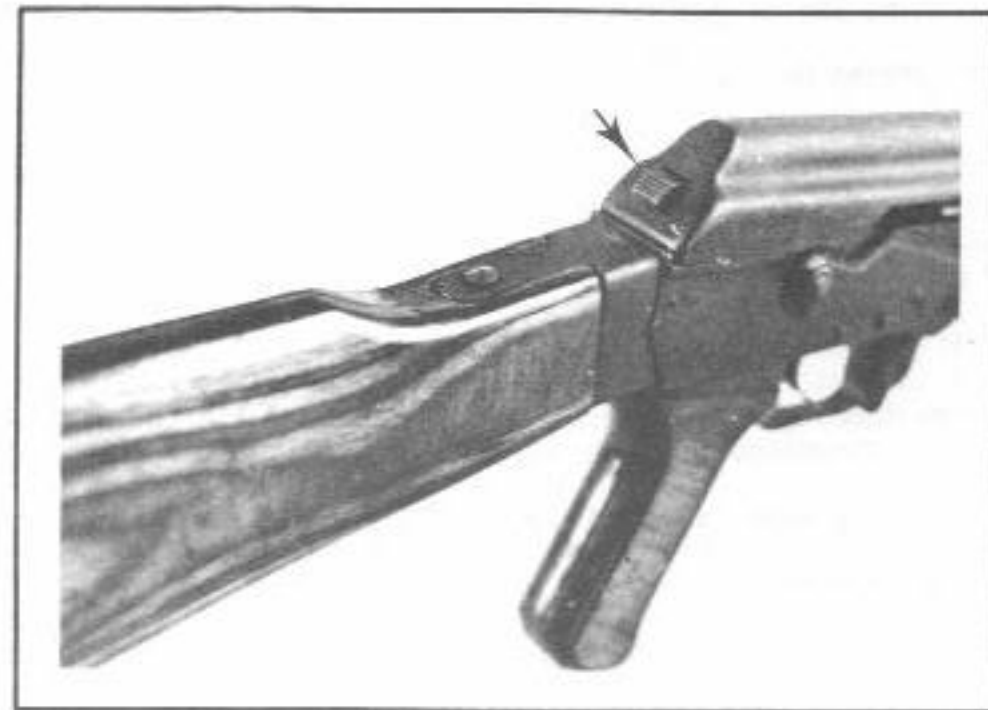

FIGURE 47. BOLT COVER SEATED

SECTION VI. ACCESSORIES

The following accessories will be issued when available with the AK-47: (fig 48).

1. Combination Tool Kit
2. Bayonet
3. Sling
4. Blank Firing Device
5. Night Sighting Device

Night Sighting Device: The night sighting device (fig 49) is attached by snapping it over the sight. It can be moved out of the way in order to use conventional sights in the daytime. To use this device, align the luminous dots (fig 50) over each other and on the target, aim and fire.

Blank firing device: The blank firing device is installed by pressing in the muzzle nut locking plunger (fig 51), unscrewing the muzzle nut by turning it clockwise and replacing it with the device (fig 52). It is removed the same way as the muzzle nut.

CAUTION: Only blank ammunition may be fired when the blank firing device is in place. Do not use the cap of the combination tool kit as a blank firing device.

Hand grenade launcher: The hand grenade launcher is installed by removing the muzzle nut (fig 53) and screwing the launcher onto the weapon (fig 54).

To fire the grenade, insert a grenade with the pin pulled into the launcher. **CAUTION:** A special type cartridge is used for firing the grenade. Place the butt of the weapon on the ground and fire from this position. The maximum effective range the grenade can be fired is 150 meters.

The bayonet (fig 55) is affixed by positioning its loops in front of the muzzle nut and gas cylinder body, and sliding the bayonet to the rear until the bayonet catch engages the muzzle nut (fig 56). The bayonet is removed by pulling the catch, located behind the hilt, away from the handle and sliding the bayonet forward and off.

Plastic magazine: The Soviet AK-47 metal magazine is gradually being replaced by the plastic magazine (fig 57) which is lighter than the metal. The plastic magazine, because it is light weight and waterproof, is used mainly by marines, airborne and armor units.

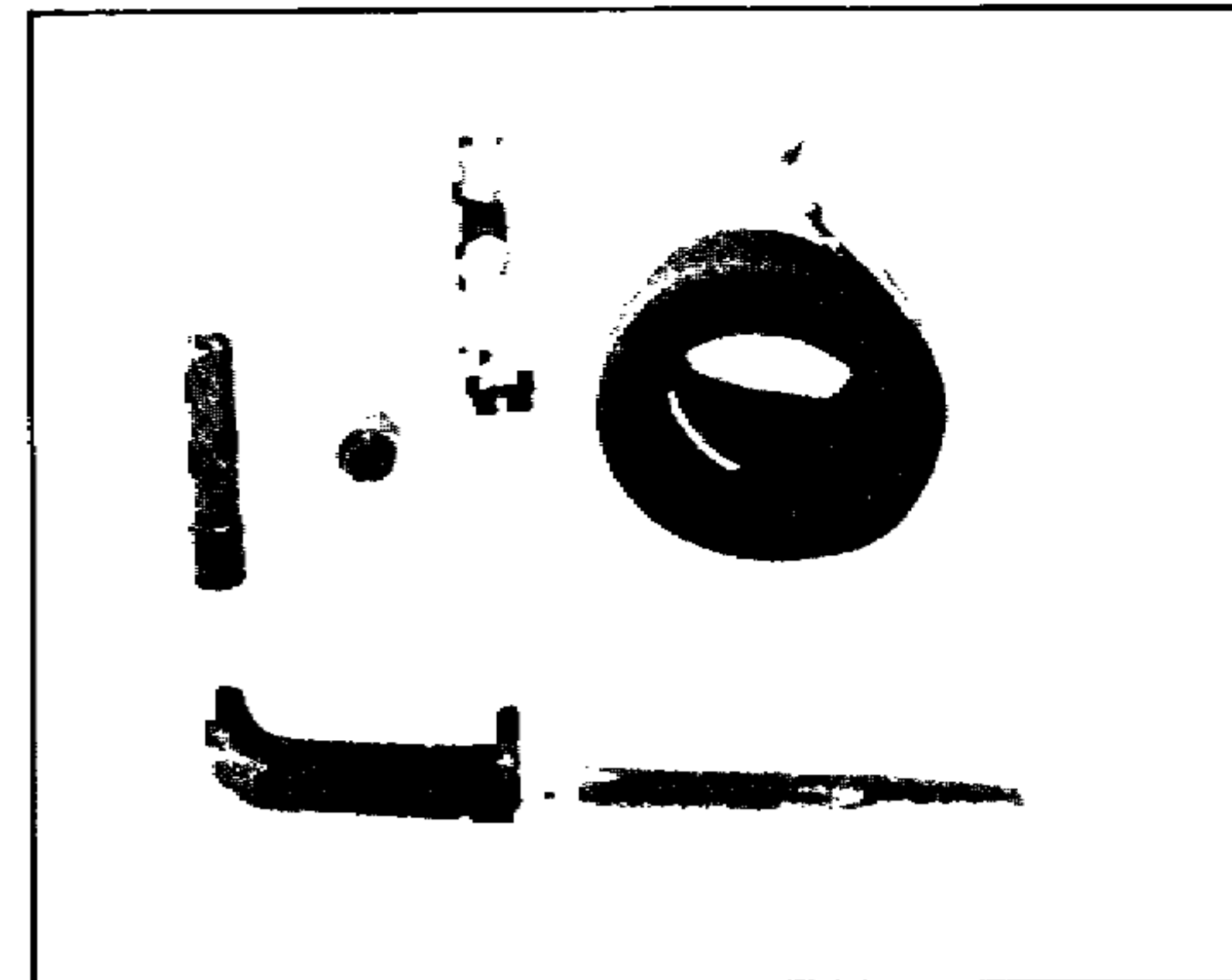

FIGURE 48. AK-47 ACCESSORIES

1. COMBINATION TOOL KIT
2. BAYONET
3. SLING
4. BLANK FIRING DEVICE
5. NIGHT SIGHTING DEVICE

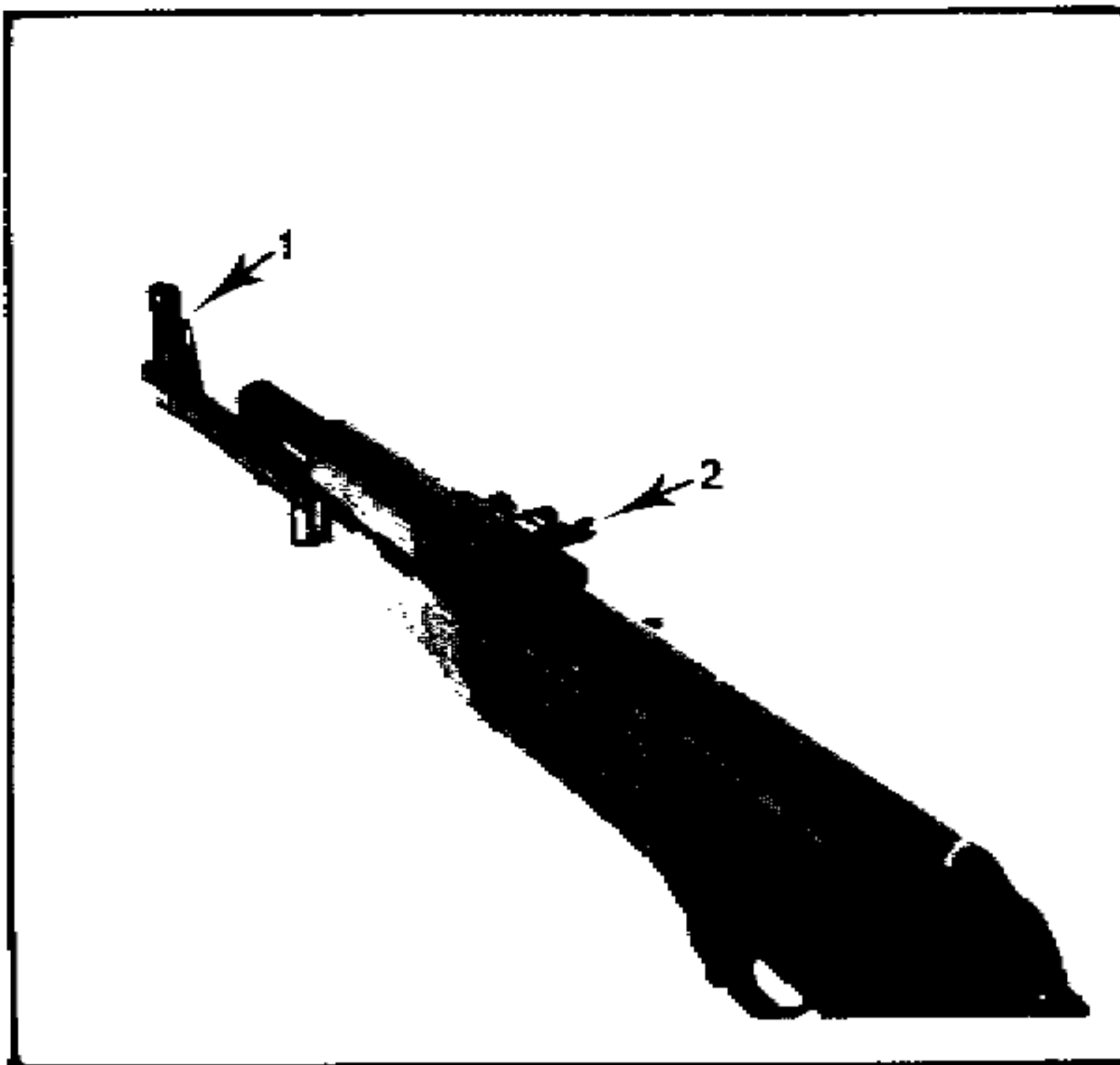

FIGURE 49. NIGHT SIGHTING DEVICE
1. FRONT
2. REAR

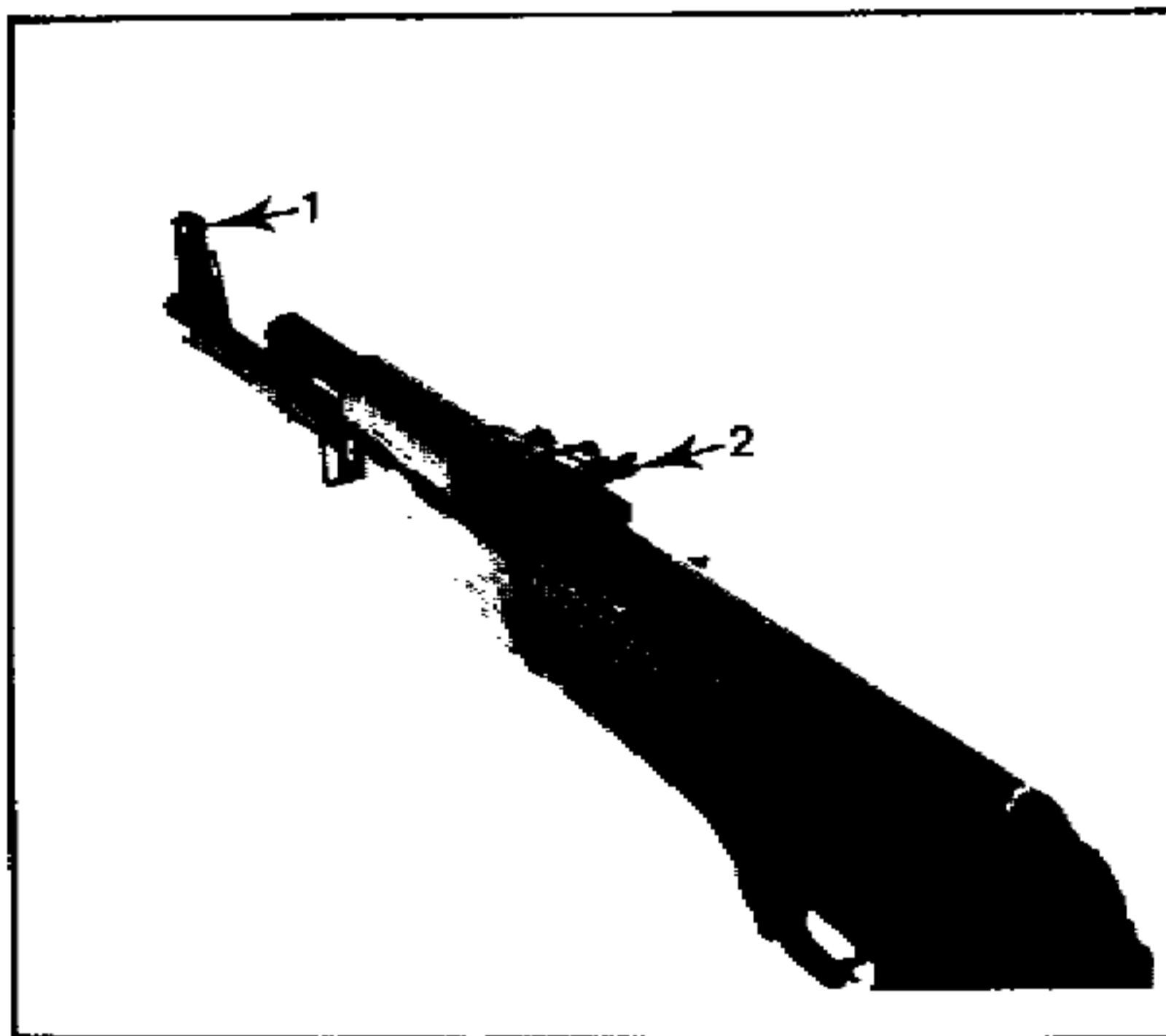

FIGURE 50. LUMINOUS DOTS
1. FRONT
2. REAR

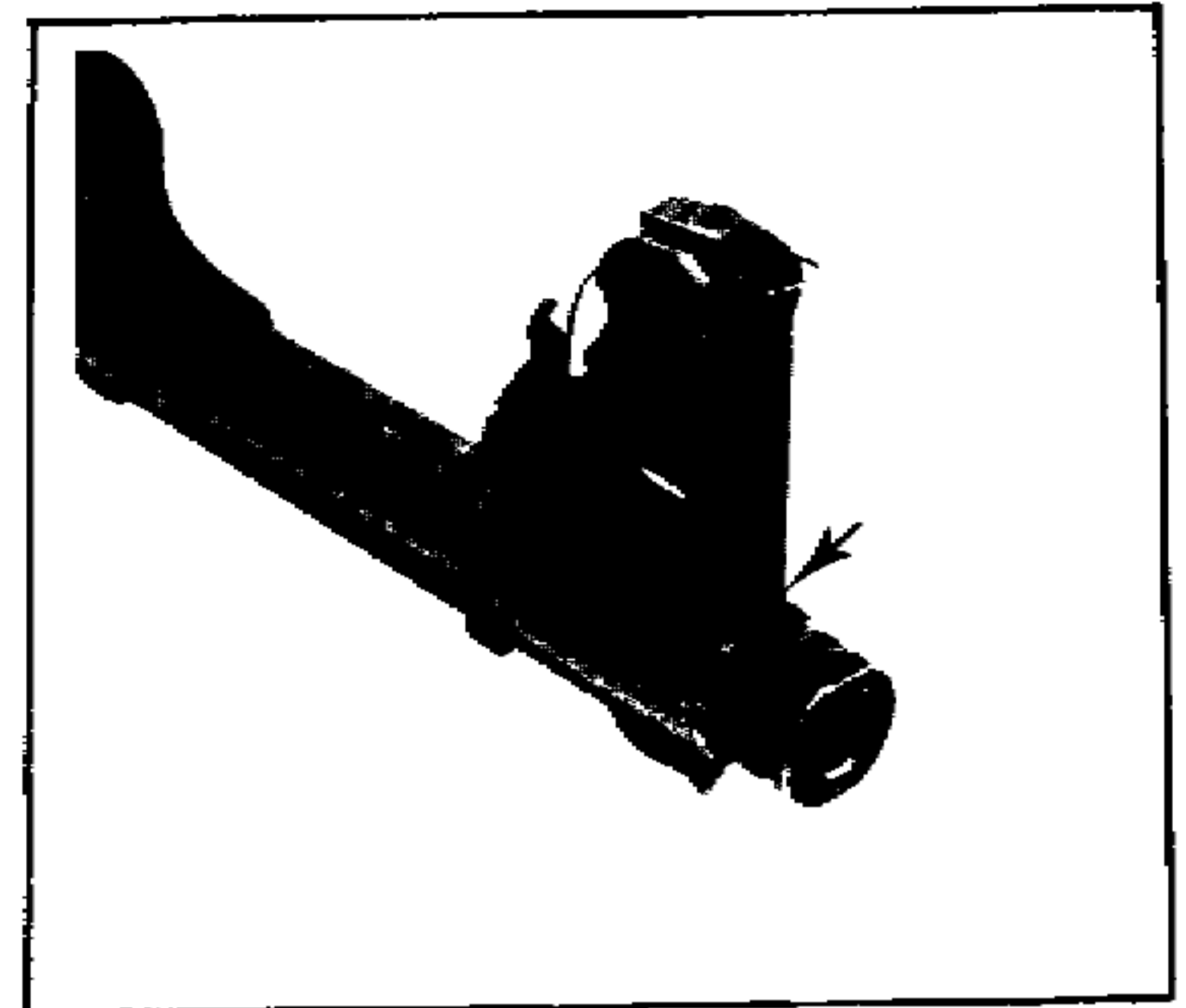

FIGURE 51. LOCKING PLUNGER

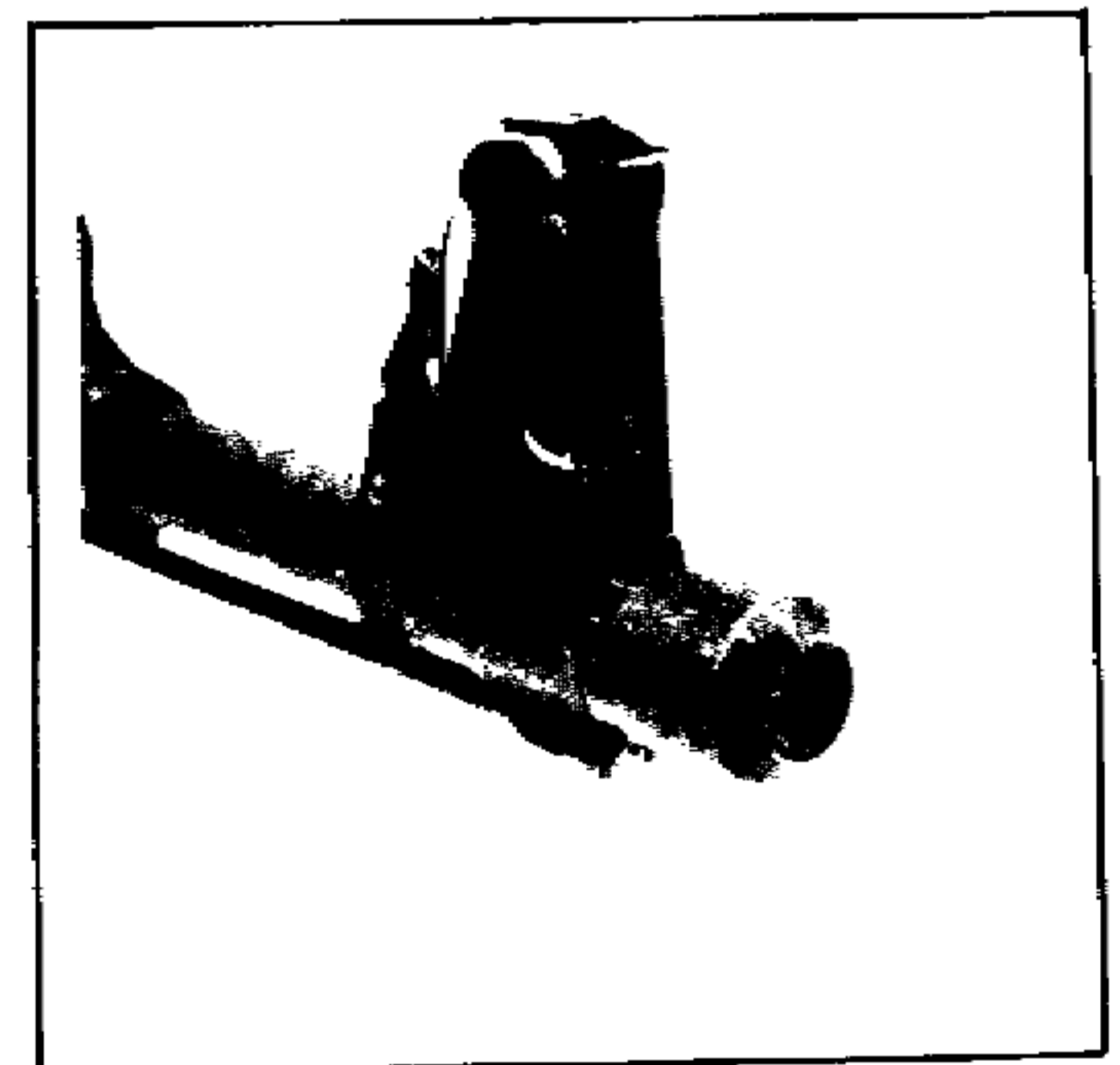

FIGURE 52. BLANK FIRING DEVICE

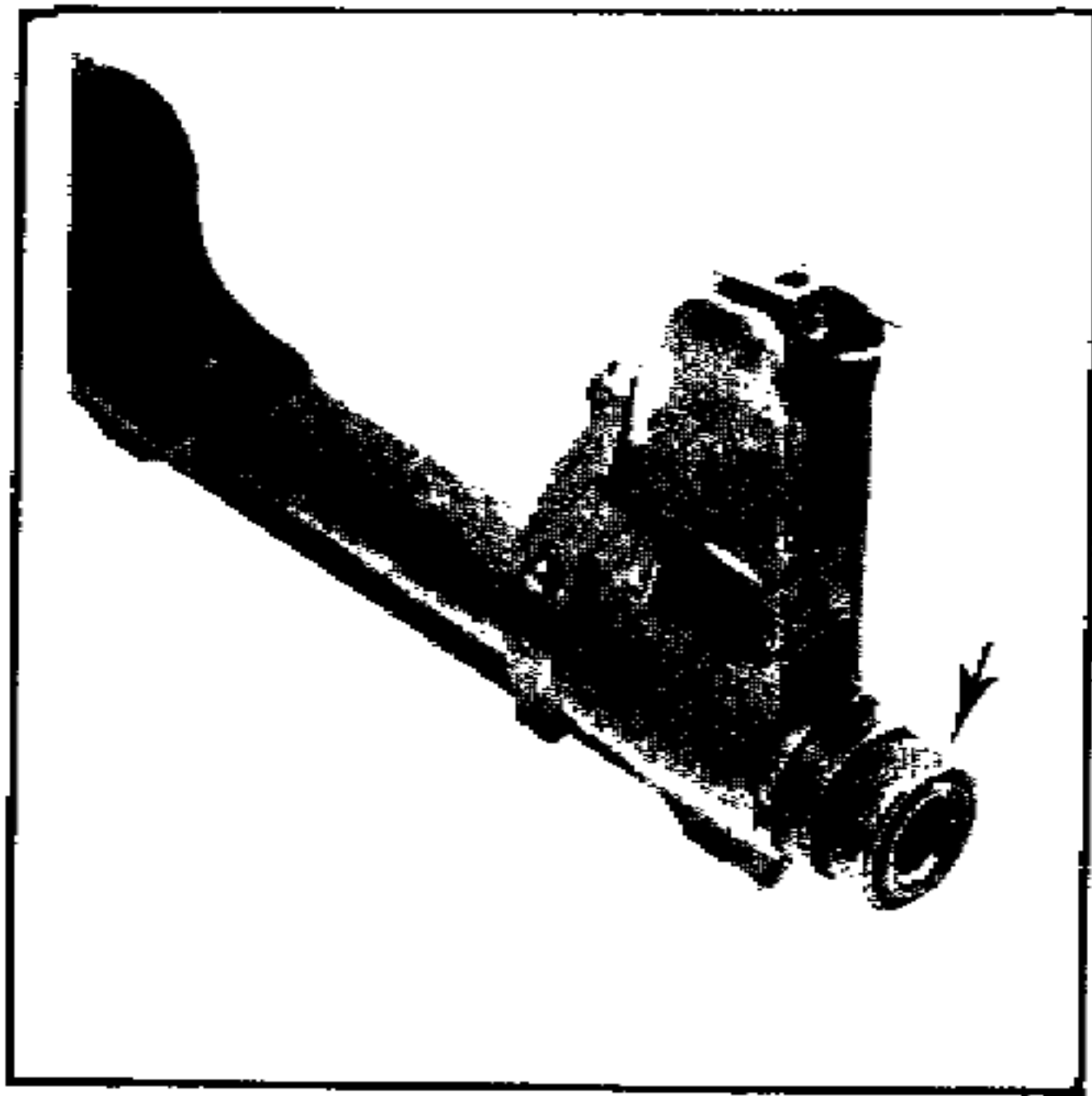

FIGURE 53. MUZZLE NUT

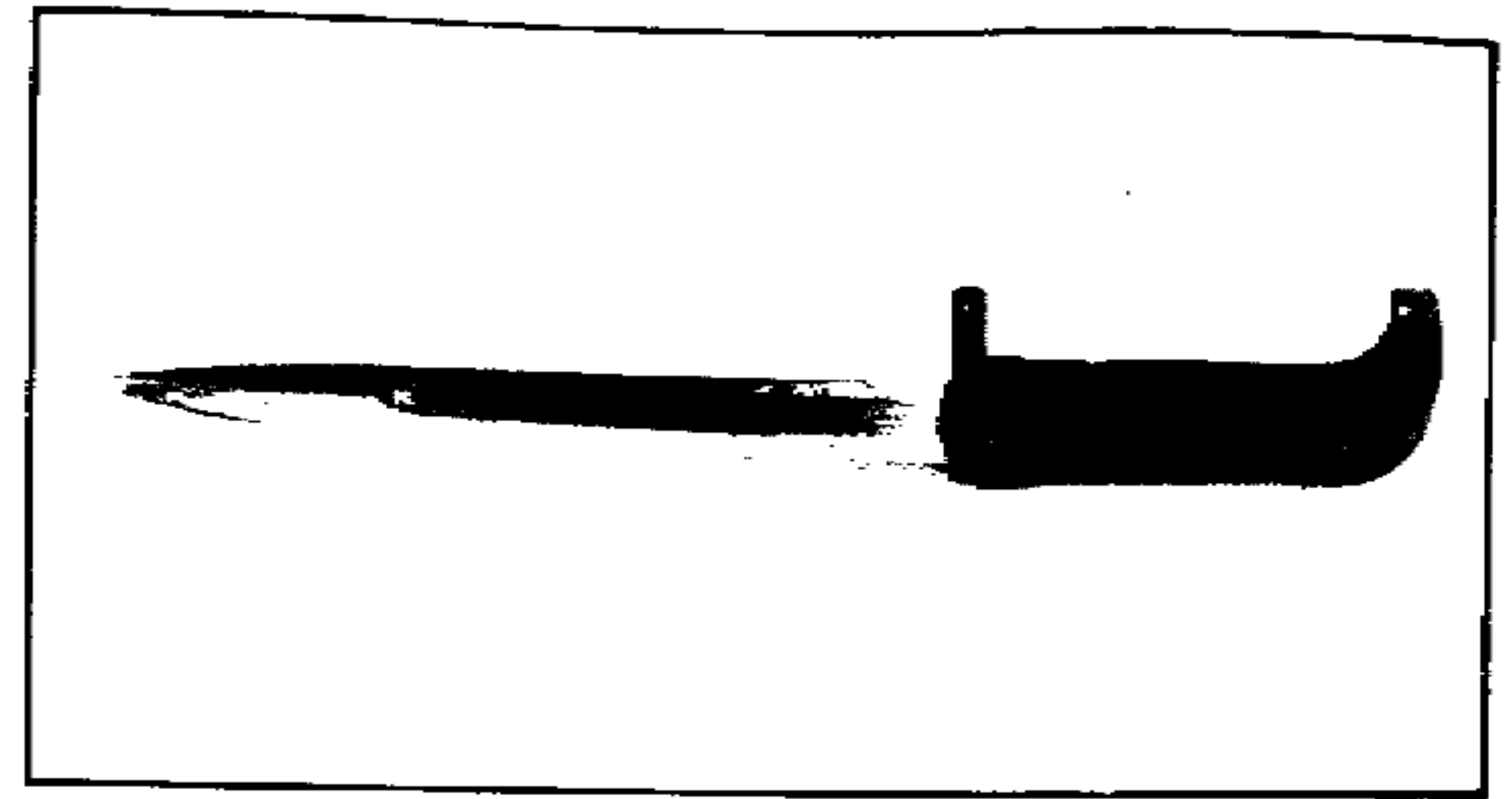

FIGURE 55. BAYONET

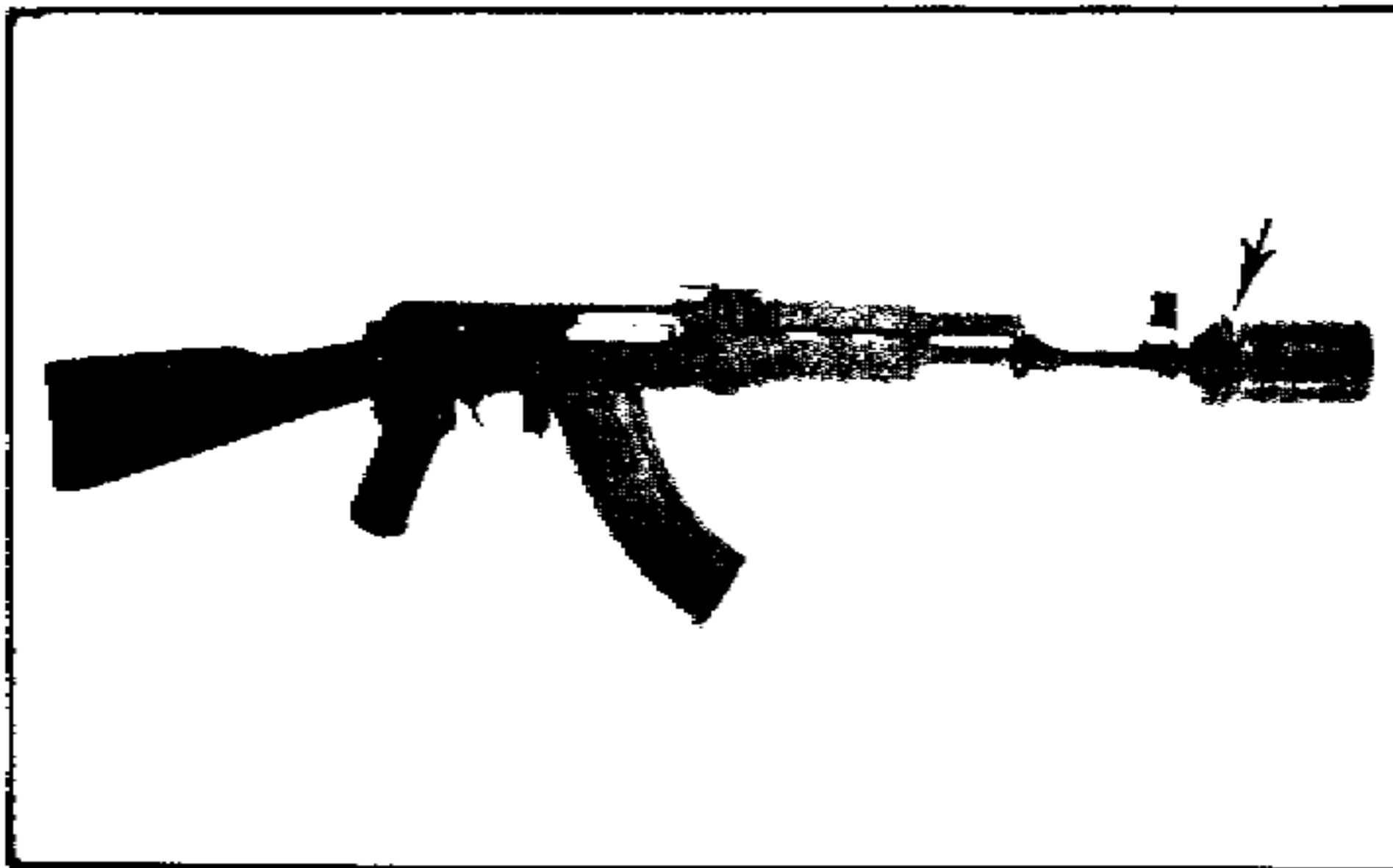

FIGURE 54. LAUNCHER

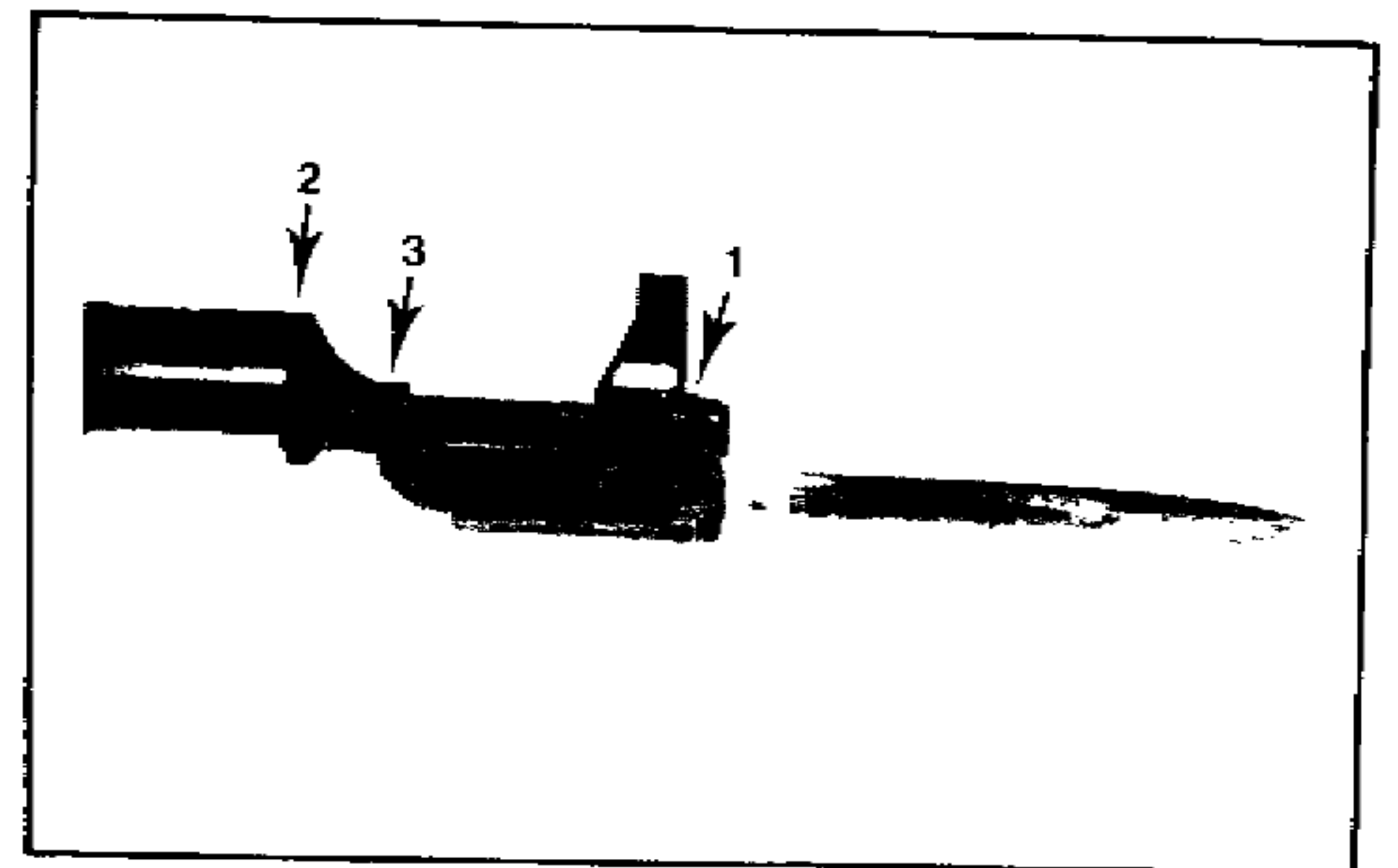

FIGURE 56. BAYONET

- 1. MUZZLE NUT
- 2. GAS TUBE
- 3. LOOP

SECTION VII. MAINTENANCE

Care and cleaning: The AK-47 rifle must be kept in proper working order and be ready for action. This is achieved by timely and capable cleaning and lubricating.

The AK-47 assault rifle should be cleaned:

--- During preparation for firing.

--- After firing with ball and blank cartridges. The receiver, bore, chamber, gas piston, slide and bolt are cleaned and lubricated immediately after firing. Final cleaning takes place daily over the next three or four days.

--- During any combat situation and in extended exercise; daily during noncombat action periods.

--- No less than once a week if the rifle is not used. Oil should be placed only on well cleaned and dry metal surfaces immediately after cleaning so that moisture is not allowed to form on the metal.

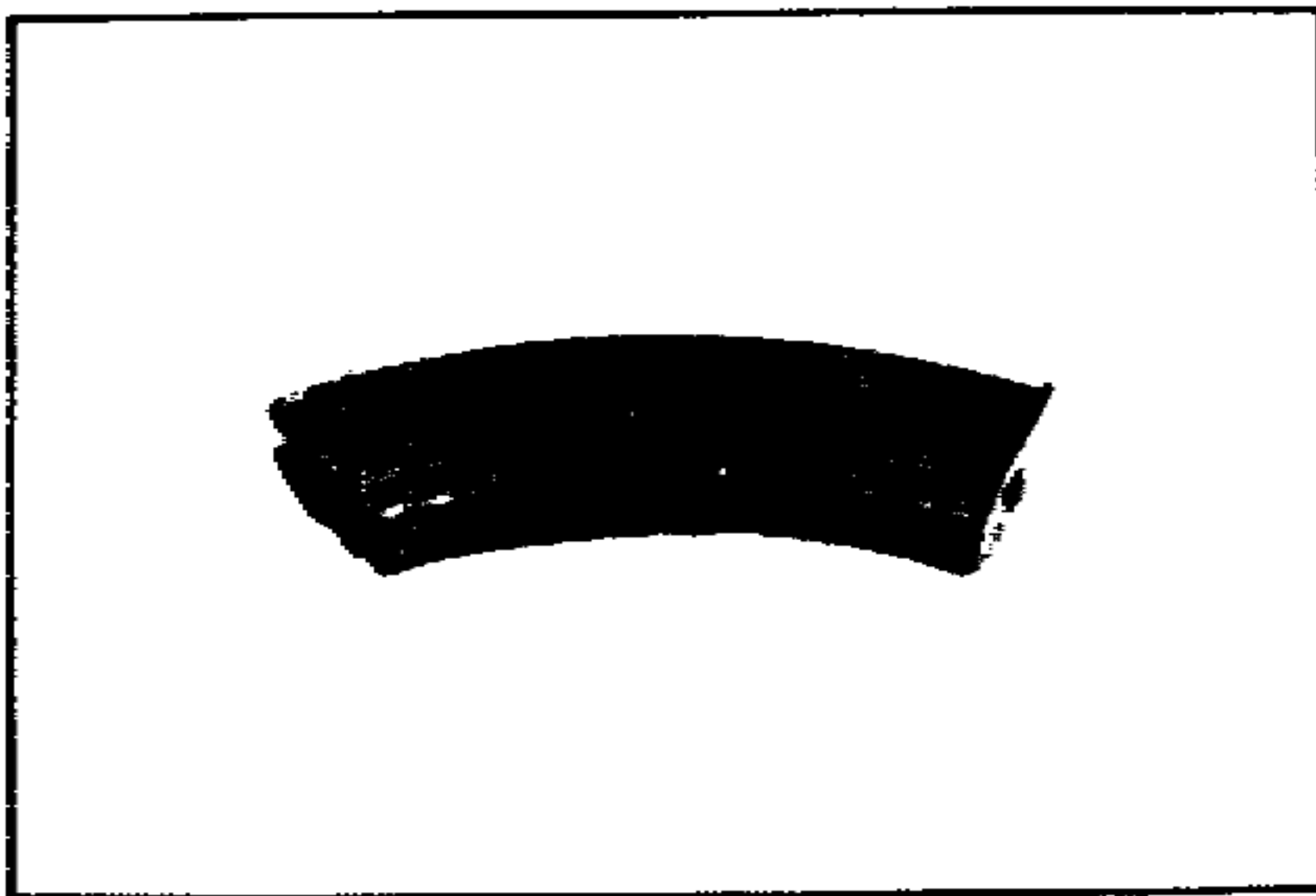

FIGURE 57. PLASTIC MAGAZINE

SECTION VII. MAINTENANCE

Care and cleaning: The AK-47 rifle must be kept in proper working order and be ready for action. This is achieved by timely and capable cleaning and lubricating.

The AK-47 assault rifle should be cleaned:

--- During preparation for firing.

--- After firing with ball and blank cartridges. The receiver, bore, chamber, gas piston, slide and bolt are cleaned and lubricated immediately after firing. Final cleaning takes place daily over the next three or four days.

--- During any combat situation and in extended exercise; daily during noncombat action periods.

--- No less than once a week if the rifle is not used. Oil should be placed only on well cleaned and dry metal surfaces immediately after cleaning so that moisture is not allowed to form on the metal.

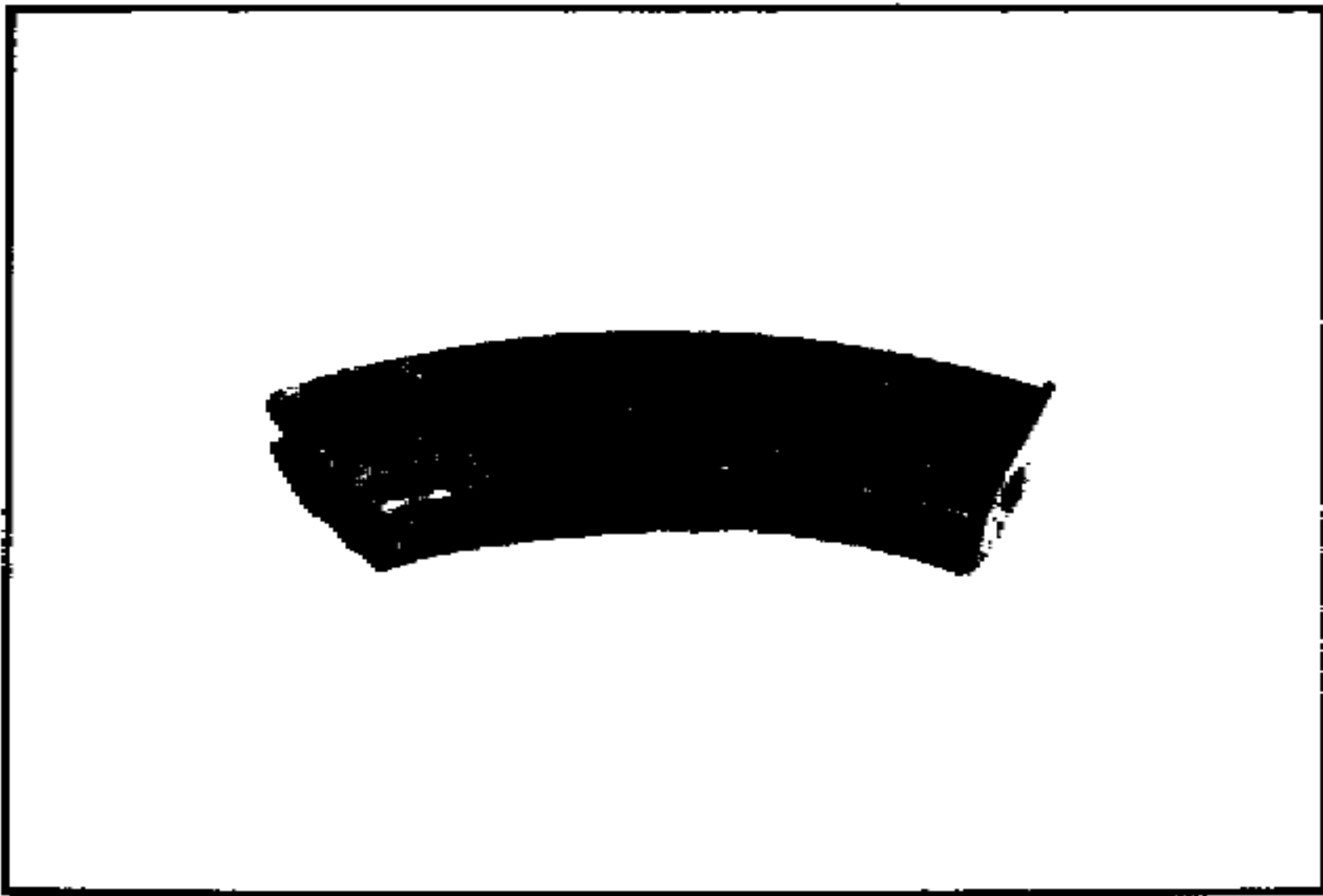

FIGURE 57. PLASTIC MAGAZINE

SECTION VIII. SERVICE AND TRAINING AMMUNITION

The AK-47 automatic rifle fires the 7.62x39mm round, M1943. The rounds have varying construction depending upon their purpose. The weight of the bullets and their muzzle velocity are selected so that firing with the different bullets can be conducted with the same sight settings. Ammunition is divided into service and auxiliary types.

1. Service ammunition and its use

Service ammunition is divided into ball cartridges and special purpose cartridges.

Ball ammunition is used to engage enemy personnel.

Special ammunition, depending upon its construction, is designed for target indication and correction of fire, igniting fuel and highly inflammable objects, and for destroying lightly armored targets.

Tracer cartridges are designed for target indication, fire adjustment, signal purposes and engaging personnel. Tracer bullets can ignite straw roofs, dry grass, etc. The path of the bullet is indicated by a red flame. The flame can be seen for a distance of 700 meters.

AP-incendiary cartridges are used to destroy fuel (kerosene, gasoline) and for destroying targets protected by thin armor plating at ranges up to 300 meters.

Incendiary cartridges are used to destroy fuel in iron tanks up to 3 millimeters thick. Incendiary cartridges also contain a tracer element. The path of the bullet is indicated by a red flame which can be seen day or night. It can be seen for a distance up to 700 meters.

2. Training Ammunition, purpose and construction

Training ammunition includes drilled and blank 7.62mm rounds, M1943.

Drilled rounds are designed for training in loading and firing. On the body or the cartridge case there are longitudinal grooves, and on the cartridge case mouth there are marks from the clamping device. The primer is pierced. There is no propellant in the cartridge case.

Blank cartridges are designed for simulating fire and are used in tactical exercises. There is no bullet in the blank cartridges. The mouth is sealed by a star (rosette) crimp. It is dangerous to stand closer than 10 meters away from the muzzle face when blank cartridges are being fired.