

DDB-2680-32-84



**DEFENSE
INTELLIGENCE
AGENCY**

Handbook of the Chinese People's Liberation Army

NOVEMBER 1984

Handbook of the Chinese People's Liberation Army

DDB-2680-32-84

Information Cutoff Date: 1 August 1984

This publication supersedes
Handbook of the Chinese Armed Forces, 1976
(DDI-2680-32-76)

This is a Department of Defense Intelligence Document prepared
under an interagency agreement for the Eastern
Division, Directorate for Research,
Defense Intelligence Agency

Distribution Statement

This document has been produced for official use within the US Government, and distribution is limited to US Government agencies. Requests for this document from outside the US Government must be referred to the Defense Intelligence Agency, Washington, D.C. 20301-6111.

PREFACE

This handbook provides a summary of the Chinese People's Liberation Army. Intended for use as an aid in unit training, the handbook should prove useful to the individual soldier, sailor, airman, and marine, as well as to unit commanders and staffs.

The *CPLA Handbook* is a revised, updated version of the 1976 *Handbook of the Chinese Armed Forces*. The information and analysis contained herein are based on known Chinese practice and publications up to 1 August 1984. The effort to modernize and professionalize the CPLA, however, will foster future changes in the contents and conclusions of this handbook.

Questions and comments concerning this publication should be referred in writing to the Defense Intelligence Agency (ATTN: DB-2B), Washington, D.C. 20301-6111. Requests for additional copies should be forwarded through command approval channels, as appropriate, to DIA (ATTN: RTS-2A) using DD Form 1142, Interagency Document Request, in accordance with DIA Manual 59-3, *DIA Reference Library*.

CONTENTS

	<i>Page</i>
CHAPTER 1 — THE CHINESE PEOPLE'S LIBERATION ARMY	1
Section A — Introduction	1
1. Chinese Armed Forces	1
2. Missions	1
3. Composition	1
4. Historical Development	2
5. Doctrine	5
6. General Strategic and Tactical Principles	7
Section B — National Command and Control	8
1. The Chinese Military Command	8
2. Organization of a Front	9
3. Political Structures	10
Section C — Equipment	11
1. Operational Concept	11
2. Operational Requirements	11
Section D — Logistics	12
1. Overview	12
2. System of Supply	12
Section E — Personnel	13
1. The Chinese Commander	13
2. The Chinese Soldier, Sailor, Airman	14
CHAPTER 2 — GROUND FORCES	19
Section A — Organization	19
1. Background	19
2. Regular Ground Forces	19
3. Paramilitary Forces	22
Section B — Command and Control	23
1. Organization of Headquarters	23
2. Formation Commanders	24
3. Location and Movement of Headquarters	24
4. Orders and Instructions	24
Section C — Equipment	24
Section D — Tactical Principles	25
1. Echelons	25
2. Special Techniques	25
Section E — Maneuver	25
1. In the Attack	26
2. In the Defense	26
3. Obstacle Crossing	27
Section F — Offensive Operations	27
1. Doctrine	27
2. Application	27
3. Basic Principles	28
4. Front, Army Group, and Army Offensives	29
5. Divisions, Regiments, and Battalions	30
Section G — Reconnaissance	33
1. Means of Reconnaissance	33
Section H — Firepower	35
1. Conventional Artillery	35
2. Chemical Fire Support	36
3. Nuclear Fire Support	36

4. Tank and Antitank Fire	36
5. Offensive Air Support	36
6. Air Defense	37
Section I — Defensive Operations	38
1. Background	38
2. Forms of Defense	38
3. Organization for Defense	38
4. The Division in Positional Defense	39
5. The Mobile Defense at Division Level	42
Section J — Retrograde Operations	44
Section K — Specialized Operations	45
1. River Crossings	45
2. Airborne Operations	47
3. Warfare Under Special Conditions	47
Section L — Logistics	50
1. Overview	50
2. Ammunition	51
3. POL	51
4. Rations and Water	52
5. Medical	52
6. Recovery and Repair	53
Section M — Training and Schools	53
1. Basic Training	53
2. Ongoing Training	53
3. Schools and Institutes	53
CHAPTER 3 — NAVAL FORCES	55
Section A — Organization	55
1. Navy Headquarters	55
2. Fleet Commands	55
Section B — Command and Control	55
Section C — Ships	55
1. Naval Ships	55
2. Order of Battle	55
Section D — Doctrine and Tactics	56
1. General	56
2. Defensive Rings	57
Section E — Capabilities	57
1. Submarine and Antisubmarine Warfare	57
2. Surface Warfare	58
3. Antiair Warfare	59
4. Amphibious Warfare	59
5. Mine Warfare	59
6. Coastal Defense from Shore Installations	59
7. Naval Aviation	59
Section F — Logistics	60
Section G — Training and Schools	60
1. General	60
2. Recruitment	60
3. Training	60
CHAPTER 4 — AIR FORCES	63
Section A — Organization and Command and Control	63
1. Organization	63
2. Command and Control	63
Section B — Aircraft and Weapons	63

1. Aircraft	63
2. Weapons	63
Section C — Doctrine and Tactics	63
1. Doctrine	63
2. Tactics	64
Section D — Capabilities	64
1. Background	64
2. Air-to-Air Combat	64
3. Tactical Air Support	65
4. Bombing	65
5. Reconnaissance	65
6. Air Transport	66
7. Airborne Operations	66
Section E — Logistics	66
1. General	66
2. Airfields	66
Section F — Training and School	66
1. Training	66
2. Schools	67
CHAPTER 5 — BALLISTIC MISSILE FORCE	69
Section A — Organization	69
1. Historical Background	69
2. Current Strategy	69
Section B — Weapons Systems	70
1. Nuclear Weapons	70
2. Delivery Systems	70
Section C — Space Systems	71
Section D — Future Weapons Systems	71
1. Ballistic Missile Submarines	71
2. Land-Based SSM	71
Section E — Capabilities	71
1. Force Size	71
2. Credibility	71
3. Survivability	72
CHAPTER 6 — JOINT SERVICE CAPABILITIES	75
Section A — Doctrine	75
1. Background	75
2. Developments Under the Military Modernization Program	75
Section B — Capabilities	75
1. Background	75
2. Joint Service Operations	78
3. Joint Service Exercises	79
CHAPTER 7 — UNIFORMS AND INSIGNIA — AWARDS AND DECORATIONS ..	81
Section A — Uniforms and Insignia	81
1. Background	81
2. Ground Forces Uniforms	82
3. Navy Uniforms	83
4. Air Force Uniforms	84
5. Foul Weather Gear	85
6. Special Uniforms	85
7. Insignia	86
Section B — Awards and Decorations	86
1. Background	86
2. Medals and Badges	86

ILLUSTRATIONS

1. Military Regions	20
2. Penetration-Envelopment Attack	28
3. One Point, Two Sides	28
4. Divide and Destroy	28
5. The Attack	29
6. The Movement to Contact and Meeting Engagement by an Infantry Division	31
7. Effective Range of Chinese Means of Reconnaissance	35
8. Division Defense Boundaries	38
9. Positional Defense — The Division	39
10. Mobile Defense — The Division	43
11. System of Supply	51
12. CPLA Navy Organization	55
13. Naval Order of Battle and Major Bases	56
14. Organization of CPLA Air Forces	63
15. Army Personnel Uniforms and Insignia	87
16. Army Personnel Uniforms and Insignia	88
17. Naval Officers Uniforms and Insignia	89
18. Naval Enlisted Uniforms and Insignia	90
19. Air Force Personnel Uniforms and Insignia	91
20. Air Force Personnel Uniforms	92
21. People's Armed Police Force Uniforms and Insignia	92
22. Chinese People's Liberation Army Awards	93
23. New CPLA Honor Guard Uniforms	94
24. New CPLA Honor Guard Uniforms and Insignia	95

APPENDIXES

A. Military Organization of China	A-1
B. Organization of an Army	A-2
C. Organization of an Infantry Division	A-3
D. Organization of an Infantry Regiment, Infantry Division	A-4
E. Organization of an Infantry Battalion	A-5
F. Organization of an Airborne Division	A-6
G. Organization of a Tank Division	A-7
H. Organization of a Tank Regiment	A-8
I. Organization of a Mechanized Infantry Regiment, Tank Division	A-9
J. Organization of an Artillery Division	A-10
K. Organization of an Antiaircraft Artillery Division	A-11
L. Organization of an Engineer Regiment	A-12
M. Organization of a Pontoon Bridge Regiment	A-13
N. Organization of a Signal Regiment	A-14
O. Organization of a Motor Transport Regiment	A-15
P. Organization of a Border Defense Division	A-16
Q. Organization of an Internal Defense Division	A-17
R. Organization of a Garrison Division	A-18
S. Probable Militia Organization	A-19
T. Probable Organization of the Xinjiang Production and Construction Corps	A-20
U. Chinese Ground Forces Equipment	
Annex 1 — Armored Vehicles	A-21
Annex 2 — Infantry Weapons	A-23
Annex 3 — Artillery	A-25
Annex 4 — Engineer Equipment	A-29
Annex 5 — Signal Equipment	A-30
Annex 6 — Tracked Tractors	A-33

Annex 7 — Load-Carrying, Wheeled Vehicles	A-34
Annex 8 — Chemical Equipment	A-36
V. Naval Vessels	A-37
W. Air Force Inventory	A-38
X. Representative Air Force Aircraft Silhouettes	A-39
Y. Chinese Missile Type and Probable Characteristics	A-44

CHAPTER 1

THE CHINESE PEOPLE'S LIBERATION ARMY

SECTION A — INTRODUCTION

1. CHINESE ARMED FORCES

The Chinese People's Liberation Army (CPLA) — the collective name for the armed forces of the People's Republic of China (PRC) — is the world's largest military force. The CPLA, which encompasses the Army, the Navy, the Air Force, and the 2d Artillery (ballistic missile force) has a total strength of 4.2 million troops. The ground forces total some 3.25 million troops and support personnel, or about 80 percent of the CPLA's total manpower. The Navy and Air Force, though significantly smaller, are the largest in the world.

2. MISSIONS

The deployment, composition, and size of the Chinese Armed Forces are dictated by their following roles:

- to defend the territory of China;
- to deter attack by any nation and, should deterrence fail, to bring any war to a conclusion favorable to China;
- to assist in the maintenance of internal security;
- to engage in production and construction work and aid in the national development of China; and
- to support the foreign policy objectives of China.

3. COMPOSITION

The total Chinese Armed Forces consist of the



Tanks, Troops, Self-Propelled Artillery and APC's before Combined Arms Exercise (Zhangjiakou, 1981)

CPLA augmented by the militia and local paramilitary organizations. The CPLA includes the Army (ground forces), the Navy (includes naval air force), the Air Force (includes air defense), and the ballistic missile force. The Armed Forces are controlled by the Central Military Commission through the General Staff, General Political, and General Logistics Departments.

4. HISTORICAL DEVELOPMENT

a. Origins

The birthplace of the CPLA is Nanchang, Jiangxi Province, where on 1 August 1927, Zhou Enlai and Zhu De led some 30,000 Communists and dissident members of the Kuomintang's National Revolutionary Army in a revolt against Chiang Kai-shek's newly established central government in Nanjing. This marked the final dissolution of the Chinese Communist Party (CCP) - Kuomintang (KMT)¹ coalition, which had been formed to provide a unified front against the warlord regimes that had ruled most of China since the collapse of the Qing Dynasty in 1911. The Nanchang uprising and other CCP-led revolts were suppressed, but the survivors fled to the Jinggang Mountains of southern Jiangxi where they joined forces. Thus, the Communists lost the first round of the political contest because their opponents, the Nationalists, controlled the armed forces; to survive, the Communists had to build their own army.

b. The Long March

During the period 1930-34, the Nationalists undertook five major "annihilation campaigns" against the Communist forces in Jiangxi Province. They finally succeeded in encircling the Communists but, in October 1934, with Zhu De as commander in chief and Mao Zedong as chief political officer, the Red Army broke through the encirclement and, together with forces from other areas, began the epic 6,000-mile "Long March," which ended 1 year later in Yan'an, Shaanxi Province.

c. Anti-Japanese War

The political struggle between the Nationalists and the Communists continued despite efforts to halt the fighting and form a united front against Japanese aggression which had begun in 1931. In 1937, the KMT and CCP agreed to join in a united front against the Japanese. Communist forces were nominally integrated with the Nationalist Army, but relations were strained at best. After serious clashes between KMT and CCP forces in eastern

China in 1941, both sides turned to husbanding their strength and avoiding large-scale combat with the Japanese. While the Nationalists were confined to Sichuan Province in western China, the Communists led the popular resistance behind Japanese lines in North China and substantially increased the size of their army.

The Japanese surrender in August 1945 precipitated a race between the Nationalists and Communists for control of territory and population. Communist forces under Lin Biao moved an estimated 100,000 troops into the rich industrial area of Manchuria (Northeast China), which the Soviet Army had overrun in the last week of the war. After the Soviet withdrawal in 1946, the Communist forces, by then renamed the Chinese People's Liberation Army (CPLA), acquired stocks of Japanese arms and equipment. The Nationalist armies, which outnumbered the CPLA, were equipped with substantial quantities of US arms and materiel.

d. Civil War

Civil war was renewed in July 1946 after negotiations failed to produce a political settlement. The Nationalists secured the cities and main lines of communication, while the Communists controlled the countryside and waged a war of attrition. The strength of the Communist forces had grown to over 1 million troops, with a militia of about 2 million. During the summer of 1947, the CPLA embarked on large-scale offensive operations against the Nationalists which destroyed KMT forces piecemeal through a combination of guerrilla and conventional warfare. Following the fall of Beijing in January 1949, Nationalist resistance virtually collapsed. In March of that year, the CPLA crossed the Changjiang River and captured Nanjing; a month later Shanghai fell. In August, the Nationalist government withdrew to Taiwan. On 1 October 1949, the People's Republic of China (PRC) was founded.

e. Communist Victory and Consolidation

(1) Ground Forces

The CPLA of 1949 was basically a peasant-infantry force with limited firepower, mobility, communications, and logistics. It had defeated a far better equipped army which had initially outnumbered it, and had demonstrated an ability to move from guerrilla tactics to large-scale conventional warfare. Nevertheless, the CCP clearly recognized the need to modernize its military establishment. This modernization process was initiated with the

¹ The Kuomintang (or Nationalist Party) was founded in 1912 following the collapse of the Qing Dynasty in 1911. Chiang Kai-shek (1887-1975) assumed leadership of the Kuomintang on the death of Sun Yat-sen, its key founder, in 1925. The CCP was founded in 1921 and Mao Zedong (1893-1976) emerged as its supreme leader in 1935.

signing of the 1950 Treaty of Friendship, Alliance, and Mutual Assistance between China and the Soviet Union.

(2) *Naval Force*

The CPLA Navy grew out of units formed when the Chinese Communist ground forces gained control over large segments of the China coastline and a number of naval units and facilities fell into Communist hands in the late 1940s. An assortment of abandoned and captured ships and craft was deployed against withdrawing Nationalist Chinese troops and provided the nucleus of the CPLA Navy.

The Navy was formally established in September 1950 when the various regional naval forces were unified and placed under the direct command of the CPLA General Headquarters. A Naval Air Force was created in 1952.

A reorganization of the Navy followed the governmental reorganization of August 1954. All duties of the previously existing naval districts were relegated to fleets, the headquarters of which were subordinate to naval headquarters. The Naval Air Force was expanded at that time.

Soviet aid increased after 1953. Between 1954 and 1960 the Soviet Union supplied China with a variety of combatants, and Soviet advisers and instructors assisted with the organization and training. With Soviet aid, a shipbuilding industry was developed with emphasis on the construction of medium and small ships and craft, especially submarines.

In the 1960s the Navy continued to improve the quality and increase the quantity of its ships and personnel despite China's economic setbacks, the Sino-Soviet rift and the withdrawal of Soviet advisers, and the upheaval of the Cultural Revolution.

(3) *Air Force*

The CPLA Air Force was formally organized in 1949. Its origins, however, can be traced to the 1930s when the Communist forces of Mao Zedong acquired aircraft belonging to the Nationalist Government. The force was further increased in 1946 with captured Japanese aircraft and in 1949 when the Communists gained control of mainland China. The Korean War heralded a period of rapid modernization with the Soviet Union supplying large numbers of jet aircraft and providing aircrew training. Deteriorating Sino-Soviet relations climaxed in 1960 when the Soviets recalled their technicians and withdrew military aid. By then, however, China had aircraft production facilities in the Northeast and some experience in jet aircraft production. A Chinese version of the MiG-17 (F-5) was produced under Soviet license in the mid- to late-1950s. By 1965, Chinese technology had progressed considerably;

they were able to begin series production of the MiG-19 FARMER (Chinese designation is F-6) and later the Il-28 BEAGLE (Hong-5), Tu-16 BADGER (Hong-6), and limited numbers of MiG-21 (F-7) FISHBED. The first aircraft both designed and produced by the Chinese, the A-5 FANTAN fighter-bomber, entered the inventory in the early-1970s.

(4) *Ballistic Missile Force*

China's ballistic missile force had its beginnings in 1958 when the CPLA established a guided missile "seed" unit which between then and 1960 was given samples of Soviet strategic and tactical rockets and missile systems. Formally known as the CPLA 2d Artillery Corps, the unit set out early in its existence to overcome the withdrawal of Soviet technical aid and to concentrate on the development of advanced surface-to-surface missile systems. The first successful SSM nuclear test, probably using the single-stage DONGFANG (East-Wind)-2, occurred in 1966. By 1980, China had test-fired two two-stage ICBM DF-5 missiles. The 2d Artillery Corps also has been involved in the development of space systems using booster variants of the DONGFANG missile series.

f. Korean War

Additional impetus to the CPLA's modernization process was provided by its experiences in the Korean War, which the CPLA entered in October 1950 under the title of the Chinese People's Volunteers. In Korea, initial successes aside, the Chinese quickly learned that in the offensive, unsupported massed infantry attacks ("human wave tactics") against vastly superior firepower were not only unavailing but in most cases led to disastrously high losses in personnel and equipment. Furthermore, to avoid the possibility of United Nations forces entering China proper, the Chinese found themselves in a situation in which they were unable to employ the principle of strategic retreat. They were no longer able to trade space for time as they had done in the past in the vast heartland of China. For the first time, they were forced to assume a form of defense previously abhorrent to them — a linear, positional defense. China's first real use of air forces occurred in Korea. Despite Soviet training and provision of jet fighters, China suffered heavy losses to United Nations' forces.

Taking advantage of the provisions of the 1950 Sino-Soviet Treaty and of Soviet advice and assistance furnished during the Korean War, the Chinese leadership decided to modernize the CPLA generally along the lines of the Soviet model, using Soviet tables of organization and equipment (TOE) and the combined-arms concept of armor- and artillery-heavy mobile forces. Although these "foreign" con-

cepts were accepted and implemented they were tempered by *Mao Zedong Military Thought* and the particular circumstances and conditions in China. Ideological differences, sensitivity to Moscow's requests for bases on Chinese soil, and Soviet reluctance to lend support during the Taiwan Strait crisis of 1958 gave rise to disputes between Beijing and Moscow, which resulted in the total withdrawal of Soviet aid and technicians in 1960. This forced the Chinese to chart a course of military self-reliance thereafter.

g. Border War with India

During the late-1950s, Chinese relations with India slowly deteriorated due in part to conflicting claims over 60,000 square kilometers of territory that India regarded as its own. This territory included virtually the whole North East Frontier Agency (NEFA) of Assam and parts of Ladakh, particularly the area of Aksai Chin through which China had constructed a highway in 1957 linking Tibet (Xizang) and Xinjiang. In October 1962, following mutual allegations of frontier intrusions, the Chinese launched large-scale attacks in the NEFA and Ladakh. While Chinese forces penetrated as far down as the foothills of the Himalayas in the western sector of NEFA, they made only limited penetrations into the eastern sector and refrained from entering the plains of India, remaining within the territory claimed by China. On 21 November 1962, Beijing announced a unilateral cease-fire and began withdrawing its troops to the original line of actual control which prevailed before they launched their attacks.

h. Cultural Revolution

Following the withdrawal of Soviet aid to China, a series of disruptive political and economic campaigns, and a diminution of his power, Mao Zedong sought to revolutionize China once again through a purge of an increasingly entrenched bureaucracy. Mao's efforts culminated in the Great Proletarian Cultural Revolution (1966-76).

During the more strident phase of the Cultural Revolution (1966-69), the CPLA emerged as the dominant and most stable political power group in China. The military assumed a major role as leader and administrator in both party and governmental affairs, as well as in economic matters. This pre-eminence passed with the demise of Lin Biao in late 1971, although military influence in China's socio-political life remains extensive.

i. Border Clashes with Soviet Union

The signing of the 1966 Soviet-Mongolian Treaty of Friendship, Cooperation, and Mutual Assistance, the extensive buildup of Soviet forces along

the Sino-Soviet border, the enunciation of the Brezhnev Doctrine in 1968, coupled with border tensions which resulted in a series of clashes in the Amur-Ussuri border areas in 1969, brought home to the Chinese the real dangers of the Soviet threat. Concentrated efforts followed to strengthen defenses and to counter Soviet influence abroad politically. The late 1960s and early 1970s were periods of rapid military expansion as China tried to compensate for its increasingly outmoded equipment through numerical superiority in the face of a perceived threat from both the Soviet Union and the United States.

j. South China Sea Islands

In January 1974, the longstanding dispute between China and Vietnam over the Xisha (Paracel) Islands in the South China Sea came to a head. A week of skirmishes between Chinese and South Vietnamese naval forces culminated in 500 Chinese troops, with air support, occupying three islands held by South Vietnamese forces. This was the second successful joint amphibious operation undertaken by the CPLA, the first being against the Kuomintang-held Dachen Islands off Zhejiang Province in January 1955.

k. New National Defense Modernization Program

In January 1975, Premier Zhou Enlai announced the new policy of the "Four Modernizations" — the modernization of agriculture, industry, national defense, and science and technology. In the summer of that year, the CCP's Military Commission held an expanded meeting to determine the course of military modernization in China. Despite setbacks because of inner-party political opposition and severe budgetary constraints put on national defense industries, the CPLA's modernization program continues to move ahead. Lacking funds for rapidly re-equipping the CPLA, military planners have sought more up-to-date training methods and personnel policies as a means of professionalizing the force while temporarily relying on existing weaponry.

l. Border War with Vietnam

Relations with Vietnam deteriorated in the late 1970s, especially after Vietnam occupied Kampuchea in late 1978, deposing China's client regime there. Armed clashes along the Sino-Vietnamese frontier culminated in a full-scale border war. The 16-day conflict, 17 February to 4 March 1979, was China's largest military operation since the Korean War and provided a useful combat test for the participating armed forces. The results of the conflict were mixed. China sought to "teach a lesson" to Vietnam, but ended up learning lessons of its own.

Chinese ground forces achieved some successes such as penetrating well within Vietnamese territory despite heavy casualties. Problems also were encountered; communications among units were unsatisfactory and logistics were made difficult by the mountainous terrain. The CPLA had to depend to a large degree on local militia forces as movers of supplies to the front and casualties to the rear. Because of the lack of military ranks in the CPLA, inadequate communications, and an unclear chain of command, control problems were encountered. These shortcomings have gradually been added to the list of priorities for the CPLA's modernization efforts in all three services.



Zheng Jiacia, Deputy Regimental Commander and Decorated Hero of the 1979 Sino-Vietnamese Border War.

m. Foreign Military Agreements

The 30-year Sino-Soviet Treaty of Friendship, Alliance, and Mutual Assistance, signed in 1950, was abrogated by China in 1979. The Chinese have a mutual defense agreement with North Korea, signed in 1961, which provides for military aid to the Koreans. China has nonaggression pacts with Afghanistan, Burma, and Kampuchea. It also has

given military equipment and logistic support to an increasing number of countries, particularly in Africa. The major recipients of arms have been Egypt, Pakistan, Tanzania, and Zaire.

5. DOCTRINE

China's current official military doctrine is founded on *Mao Zedong Military Thought*. It incorporates the concepts of numerous military strategists such as Sun Zi (*The Art of War*, circa 350 B.C.), Napoleon, Clausewitz, and those of modern times, as well as lessons learned from the peasant rebellions of 18th and 19th century China. The primary ingredients, however, are the experiences of the CPLA in the civil war with the KMT (1927-49) and during the anti-Japanese resistance (1937-45). In the Chinese view, the CPLA was victorious in both contests, succeeding in defeating better armed foes by relying on popular support and adopting tactics based on an appreciation of the overall situation. While the explanations for CPLA victory over the Nationalist forces are plausible, the assertion of victory over the invading Japanese Army is much more debatable. Since the CPLA now is more likely to face an invasion by a modern Soviet army rather than civil war, the efficacy of a strategy based on popular mobilization and protracted war carried out by dispersed formations is open to question. On the other hand, this strategy should not be ruled out in any war of aggression against China. During the formulation of this doctrine the Chinese experience was almost entirely limited to land warfare. The same principles were adopted for naval and air forces as they grew in size and capability.

The main elements of current Chinese military policy are reliance on people's war, modernization of forces for conventional war, and continued development of strategic forces for deterrence. The Chinese are constantly striving to find a proper balance between the concept of people's war and the development of modern, professional forces capable of fighting a conventional war.

a. People's War

People's war is a doctrine for the defense of China against various types of war ranging from a surprise long-range nuclear strike combined with a massive ground invasion to a conventional ground attack with limited objectives. It is premised on participation of the whole populace and mobilization of all the country's resources for as long as it takes to defeat any invader. The doctrine of people's war is meant to assure both the Chinese people and any potential invader that in case of war there will be no surrender, no collaboration, and that even if China's conventional forces are defeated, wide-

spread and unremitting resistance will continue until the invader withdraws. Ideally, China's main forces, using conventional tactics, would carry out a strategic withdrawal supported by guerrilla operations until the invading forces were overextended and dispersed. When this occurred Chinese forces would be concentrated to annihilate the enemy.



Wen Derong, "Outstanding Draftee" and Model Artilleryman

People's war is as much a political doctrine aimed at the Chinese people as a military one aimed at foreign enemies. One goal is to avoid a repetition of China's experience during World War II when millions of citizens collaborated with the Japanese invaders, while most others considered the war a matter to be left to the armies, themselves preferring to "sit on the hillside and watch the tigers fight." In part, people's war is meant to deter potential enemies by making it clear that any invasion of China would be a very expensive proposition and one with no chance of a satisfactory resolution. Seen this way, there is no contradiction between people's war and conventional war, or between the doctrine of people's war and the establishment of modernized conventional military forces.

The founders and early leaders of the CPLA were dedicated to the development of as effective an armed force as circumstances permitted. Modernization of the CPLA has been a major policy goal since the foundation of the People's Republic in 1949. There have been disagreements over the optimal allocation of the limited resources available for national defense, as well as over the best command structure. But no responsible person in China has ever advocated either the development of a professional army distinct from the CCP or exclusive reliance on the militia. Strategic withdrawal, guerrilla operations, and defense of key industrial areas from fixed positions are all tactics, not ends in themselves, and are to be employed as circumstances demand.



Sand Table Exercise.

b. Response to the Soviet Threat

Since the late 1960s, China has reappraised its military needs because of the increased Soviet threat. This has resulted in changes in CPLA training and organization intended to improve the armed forces' capabilities for conventional operations. Positional defense has been accepted as essential for the protection of important industrialized areas. The effort to improve the training and capabilities of the CPLA to fight a conventional war and to equip the Army with modern equipment has been termed "people's war under modern conditions." In the early 1980s, increased emphasis was placed on combined-arms strategies and joint-service operations intended to improve the CPLA's ability to fight under modern battlefield conditions, and in the case of the Navy, to extend defense further out to sea.

c. Development of Strategic Forces

By the late 1950s, Beijing's leaders decided to embark on a program to develop a credible nuclear delivery capability, avowedly for strictly defensive purposes. A thorough discussion of the development of strategic forces can be found in chapter 5.

d. General Purpose Forces

Chinese ground forces have the capability, although limited in some cases because of minimal technical knowledge and equipment, to carry out all forms of conventional operations from guerrilla-type warfare to combined operations using massed armor. The air forces are constrained by equipment and weapons limitations to rudimentary support of ground and naval forces, and reliance on saturation tactics to counter enemy forces. The Navy is increasing its ability to operate effectively in regional seas, but is vulnerable to modern weapons and to air attack beyond the limits of its shore-based air force.

e. Nuclear Operations

Though there is no confirmed doctrine on nuclear warfare, the Chinese are well aware that the advent of nuclear weapons has generated many new features in warfare, and they appear to have the necessary training and knowledge to lessen the effects of nuclear weapons employed against them. Chinese nuclear weapons apparently are intended to serve as a deterrent against any would-be aggressor and Beijing has repeatedly stated that it would not be the first to use them in a war.

f. Antichemical-Biological-Radiological Operations

The Chinese believe that the most effective protection against chemical, biological, and nuclear weapons is the timely detection and destruction of the enemy's stockpile of these weapons. In addition, efforts would be made to construct airtight protec-

tive fortifications with ventilation systems capable of filtering out contaminated air. People and animals would be inoculated against epidemics and troops are provided with protective equipment. Observation and reporting units would be established to give the forces notification of a possible chemical, biological, or nuclear attack.

After the attack, adequate measures would be taken to decontaminate the area and treat injured and infected people.

6. GENERAL STRATEGIC AND TACTICAL PRINCIPLES

Inherent in Mao Zedong's military writings are numerous strategic and tactical principles, many having a heavy emphasis on politics. These principles, although not adhered to as rigidly as they were before Mao's death, are generally used in both planning and operation.

- *The aim of war.* War aims to destroy the effective strength of the enemy rather than to hold areas or cities.

- *Security.* Conservation of the strength of one's own forces is essential to any military operation.

- *Mobility.* Withdraw before the enemy's advance; pursue the enemy's withdrawal; disperse or concentrate one's own forces swiftly on a wide and flexible battlefield.

- *Local superiority.* Concentrate overwhelming strength against the enemy's weaker points; accept a decisive engagement only with two to six times the enemy's strength.

- *Offensive action.* Attack is the primary method of destroying the enemy; surround the enemy and attack from at least two directions.

- *Singleness of direction.* Strategically, there must be only one main direction at a time; tactically, there must be a single objective.

- *Flexibility.* Tactics must be ingenious and flexible, suited to the time, the place, and the situation.

- *Surprise.* One's own forces must be assembled in secrecy and must attack at the time and place which the enemy least expects.

- *Initiative.* Always seize the initiative, preserve one's own freedom of action, and force the enemy to retreat.

- *Unity of command.* Unified command is essential to success, particularly in the coordination of guerrilla and regular forces.

- *Preparation.* Combat requires meticulous preparation to avoid entry into battle without assurance of success.

- *Confidence.* Victory is determined by the confidence of commanders and troops in the inevitable triumph of their cause.

In addition to these principles, the Chinese place great emphasis on the maintenance of morale. Apart from the normal concerns for morale common to all armies, political commissars are found at all levels down to and including companies. They are responsible for the morale, motivation, and political education of all personnel.

It has already been stated that Chinese strategy is concerned with the defense of the mainland against various levels of warfare. This strategy is based on the people's war doctrine in which the CPLA, in concert with the various paramilitary forces, would conduct a strategic withdrawal through successive defensive belts until the enemy is tactically and logistically overextended. By this method of trading space for time, the Chinese hope to concentrate sufficient forces to assume the offensive and destroy the enemy. It is believed, however, that the Chinese would probably defend certain key political and industrial areas in the more conventional positional-type defense.

It must be realized that the CPLA, essentially an infantry force, has tailored its tactics to maximize these capabilities. The Chinese endeavor to get as close as possible to the enemy — "to embrace the enemy" — in the belief that in close combat they are superior to all other armies. They are also convinced, from their years of guerrilla warfare, that infiltration is most important and should be reflected in all their tactics. In addition, the majority of operations should occur at night.

Also, Chinese doctrine insists that offensive operations are the only way to victory. Defense is assumed only in the face of a superior enemy force in order to gain time to concentrate forces before resuming the offensive. The Chinese believe that defensive operations must be active; they reject passive defense and consider it the quickest way to defeat and disaster.

SECTION B — NATIONAL COMMAND AND CONTROL

I. THE CHINESE MILITARY COMMAND

Command and control of the CPLA is exercised de jure by the Central Military Commission, a State organ supervised by the Standing Committee of the National People's Congress (NPC). The State Central Military Commission is nominally considered the supreme military policymaking body and its chairman, elected by the NPC, is the commander in chief of the Armed Forces. De facto command and control of the CPLA, however, still resides with the Central Military Commission of the Party Central Committee, which was the highest military

organization in China prior to the 1982 revised State Constitution. The distinction between the Party and State Central Military Commissions remains blurred; the top leadership of both Commissions is identical, although the memberships do not correspond exactly.

The Ministry of National Defense, acting for the State Council, is responsible for military modernization in the Armed Forces. Operational control of the CPLA is carried out by three General Departments. They are as follows:

- *General Staff Department.* The General Staff Department performs staff and operation functions for the CPLA. This department in effect serves as the ground forces general staff headquarters in addition to discharging staff duties for the Navy and the Air Force.
- *General Logistics Department.* The General Logistics Department provides logistical support and services to the CPLA as a whole.
- *General Political Department.* The General Political Department is the organ within the CPLA responsible for matters relating to political affairs.

Specific operational functions are carried out, as directed by the General Staff Department, by the headquarters of the various arms and services. These include the Navy, Air Force, 2d Artillery (ballistic missile) Corps, Armored Corps, Artillery Corps, and Engineer Corps. There is no ground force or infantry headquarters as such. The Railway Engineer Corps and the Capital Construction Engineer Corps were merged with civilian ministries of the State Council in 1983 while the Armored, Artillery, and Engineer Corps became subdepartments directly under the General Staff Department. The various arms and services are discussed in greater detail in subsequent chapters. The military organization of China is depicted in appendix A.



Deng Xiaoping, Chairman, CCP Military Commission and Central Military Commission, Inspecting the Troops



Zhang Aiping, Minister of National Defense and Deputy Secretary General, CCP Military Commission.

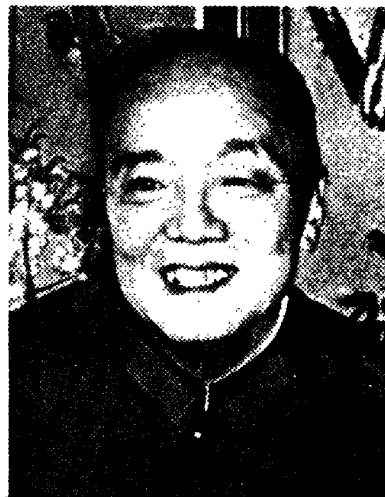

Yang Shangkun, Executive Vice Chairman CCP Military Commission and Vice Chairman Central Military Commission.



Yang Dezhi, Chief of Staff, General Staff Department and Deputy Secretary General, CCP Military Commission.



Yu Qiuli, Director, General Political Department and Deputy Secretary General, CCP Military Commission.



Li Desheng, Commander Shenyang Military Region and Member, CCP Politburo.

2. ORGANIZATION OF A FRONT

In the event of war or in response to threats to its national security, China may organize forces into "fronts." A front would include the "three-in-one" combination of the regular main forces, the regular local forces, and the paramilitary forces organized in response to the specific situation.

A possible arrangement of Chinese fronts is shown below:

Front	Military Regions	Orientation
Northeastern (Shenyang) Front	Shenyang	USSR
Northern (Beijing) Front	Beijing, Lanzhou	USSR, Mongolia
Western (Xinjiang) Front	Urumqi	USSR, Mongolia
Southwestern Front	Chengdu	India
Southern Front	Kunming, Guangzhou	Indochina
Eastern (Fujian) Front	Nanjing, Fuzhou, Jinan, Wuhan	Taiwan

3. POLITICAL STRUCTURES

a. Background

The importance of political leadership over the armed forces by the CCP has been a constant theme throughout the history of the CPLA. By the time Mao Zedong had fled to the Jinggang Mountains in 1927, he had accepted the inevitability of armed struggle as the only means by which to achieve his revolutionary goals. This struggle was to be waged by an army which was not only militarily strong but also ideologically motivated and politically loyal to the CCP and the cause it espoused. The dictum "political power grows out of the barrel of a gun, the party commands the gun, and the gun must never be allowed to command the party" has remained the basic tenet guiding political-military relations in China.

b. Politicization of the CPLA

The theory of party leadership over the CPLA consists of two distinct elements. The first is that of political control — control by the CCP over the military leadership in order to insure that its policies are implemented. The second is that of political education — the process by which support for the policies of the CCP is secured with the armed forces. Normally referred to as the process of politicization, this dual theory of political control and political education has had a direct influence on the CPLA's conception of and attitude toward its role in Chinese society, and its relationships with other actions in the Chinese sociopolitical system. Time and again politicization has been used to shape beliefs, implant values, and guide action. This insures the CPLA's loyalty to the CCP and makes the CPLA responsive to the Party's will in every respect.

Politicization in the CPLA is accomplished by means of a complex, political apparatus composed of two distinct and separate hierarchies, paralleling the military chain of command and corresponding roughly to the functional division between political control and political education: party committees and political departments.

Party Committee. The first hierarchy is composed of a series of party committees which extend downward from the CCP's Military Commission to the regimental level. At the battalion level the party committee is known as the "general branch;" at the company level, the "branch;" and at platoon level, the "cell." The party committee exists independent from but parallel to the military command structure. It is responsible to the next higher party (military organization) committee and (in peacetime) to the civilian party committee of the locality where the unit is stationed. The party committee of a given

unit is elected by all the members of the unit subject to the approval of the next higher party committee. Membership almost always includes the unit's military commander and political commissar whose selection must have the approval of the higher level party organ.

The party committee fulfills its role of political control over the military leadership by seeing that all party decisions, directives, and orders are expeditiously implemented and judiciously adhered to. In addition, the party committee is responsible for planning and policymaking within its jurisdictional spheres, for unit discipline, and for personnel matters including promotions, demotions, and transfers.

Political Commissar. The exercise of political control by the party committee is personified in the political commissar. The political commissar serves as the official representative of the party in the military unit and as such is directly responsible for all political activities in the unit. He normally serves concurrently as the secretary of the unit's party committee. The political commissar enjoys a status that is theoretically equal to that of the military commander. Under this dual command system, the commissar shares responsibility with the commander for all military work. In principle, the commander is responsible for the unit's *military* matters: combat operations, logistics, and tactical training. The commissar, on the other hand, is responsible for purely *political* matters: security, discipline, personnel affairs, and ideological training. However, over the years the political commissar has often emerged as the key figure in the command structure by virtue of his being the spokesman for the party in all matters, whether military or political.

Political Department. The second hierarchy in the political apparatus is the system of political departments. An integral part of the military's formal command structure, the political department exists parallel and subordinate to the party committee at each level of command. Political departments extend from the CPLA General Political Department in Beijing down to the regimental level political office. The personnel of the political offices supervise the battalion-level political education officers and the company-level political instructors, who in turn oversee the political activities of "political fighters" in platoons and squads.

The primary function of the political department is to implement the decisions of the corresponding party committee and to secure the support of the rank-and-file for the party's policies through political education. At regimental level and above,

the political department is subdivided into various functional sections responsible for matters relating to counterintelligence, morale, education, propaganda, welfare, and recreational/cultural work.

At the lower levels of the Army's organization, particularly at company level, the functions of the political commissar and of the representative of the political department merge in the person of a single political officer or "political instructor." Responsible for all political activities in the unit to which he is assigned, the company-level political officer embodies both the control and the educational functions of the political apparatus and serves as the vital link between the decisionmakers and the ordinary soldier.

c. Political Schools and Academies

Although political education is an essential element in the curriculum of all Chinese military schools and academies, special political schools have been established to train field grade political cadres. These include the CPLA Political Academy, in Beijing, and four or more national-level political schools. Information on admission, length of course, and curriculum is not available.

SECTION C — EQUIPMENT

1. OPERATIONAL CONCEPT

As a result of the weaknesses exposed during the Korean War, China decided to modernize its Army generally along the lines of the Soviet Army, using Soviet tables of organization and equipment (TOE) and the combined-arms concept of armor- and artillery-heavy forces. The CPLA, however, remains essentially an infantry force, and the tactics employed, dictated by the relatively few armored vehicles and the geographical constraints in certain areas, are geared to exploit foot-soldier capabilities.

2. OPERATIONAL REQUIREMENTS

a. Simplicity

The Chinese require that their equipment be relatively simple to operate, maintain, and repair. This requirement results partly from a scarcity of skilled, technical personnel and, in some instances, of spare parts. To overcome these deficiencies in the CPLA's maintenance and repair capabilities, commanders often rely on the individual soldier's skill and ability to improvise with available material and resources. Local fabrication, cannibalization, and patching are practiced in an effort to keep equipment, particularly vehicles, in service.

b. Quantity

Despite China's effort to modernize its forces, the amount of equipment produced domestically

and imported from abroad is believed to be insufficient to equip all its units according to standard TOEs. There remains a variance among units, particularly in the areas of heavy weapons and support equipment. In addition, some equipment and spare parts, especially armor and motor transport equipment, still are in short supply. The CPLA is provided with sufficient arms and equipment to conduct large-scale, conventional warfare within its own borders or against neighboring small countries that are not supported by one of the superpowers. Its capability to conduct any extraterritorial large-scale operations is limited.

c. Equipment Development

The Chinese are remodeling and re-equipping their forces to enable them to confront any adversary on more equal technological terms. Besides producing equipment of Soviet and other foreign design, the Chinese have developed and produced various types of domestically designed equipment. Major weapons of Chinese design, for example, include an armored personnel carrier, the Type 62 light and Type 63 amphibious tanks, the A-5 fighter-bomber aircraft, various antitank and guided missiles, a nuclear submarine, and an intercontinental ballistic missile (ICBM).

d. Re-equipment

The size of the CPLA, its dispersal throughout China, and the CPLA's limited logistical capability require the Chinese to expend considerable time and manpower in re-equipping their armed forces. The Chinese, therefore, normally use their equipment for as long as it is operationally functional before replacement. In addition, recovery of equipment from the battlefield is stressed. These practices, however, do not negate China's continuing emphasis on standardizing, modernizing, and replacing obsolescent equipment when required.

e. Mobility

Due to the lack of land, sea, and air transport capable of moving large numbers of forces, the CPLA has comparatively little strategic mobility outside its own borders. But it is capable of decisive tactical mobility, especially over terrain which precludes or limits the use of mechanized vehicles. As the number of armored personnel carriers and tanks increase, however, and trends toward mechanization are actualized, the CPLA will be able to conduct warfare on a broader scale than at present. In a similar manner, an increased inventory of suitable air and water transport craft may result in an increased emphasis on air transport and amphibious operations, thus enhancing the CPLA's overall mobility.

SECTION D — LOGISTICS

1. OVERVIEW

The continuing effort to modernize China's Armed Forces has required concurrent strengthening of logistical support at all levels. Considerable improvement is apparent when current supply and service procedures are compared with those of the Korean War era, when China entered that conflict with little in the way of a formalized system for the logistical support of its forces. Although there are inherent weaknesses in organization and equipment maintenance at the operational level, the CPLA's logistical (sometimes referred to in Western literature as "rear services") system, especially its supply, transportation, and medical support functions, is considered well adapted, at least in theory, to the military establishment it is intended to support.

Chinese logistical doctrine has been influenced by:

- experience gained during the Korean War;
- influx of Soviet doctrine, training, and equipment in the 1950s;
- lessons learned from their support of North Vietnamese forces and the Viet Cong in the face of enemy air supremacy;
- experience acquired in moving troops and supplies during breakdown of communications caused by the Cultural Revolution;
- redeployment of troops and equipment to the north in response to the Soviet threat; and
- similar redeployment to the southern border with Vietnam.

Strengths and Weaknesses. The following are the main strengths and weaknesses of the Chinese logistical system:

Strengths:

(1) China has the ability to mobilize civil resources, including mass manpower, to support a military effort.

(2) The stamina of the individual Chinese soldier and his familiarity with marginal living conditions simplify supply problems.

(3) Equipment is kept to the minimum required for efficient operation; rations are simple; and personal needs and comforts are few.

(4) The Chinese soldier is prepared to improvise necessities that the logistical system fails to provide.

Weaknesses:

(1) The vastness of the Chinese mainland, a less than adequate transportation system, and deficiencies in defense-related industries restrict China's logistical capability.

(2) China's logistical system remains untested in prolonged modern warfare.

(3) The need for increasing the number of qualified, lower-echelon logistical officers.

Principles. The following principles govern logistical activities in the CPLA:

- *Centralized Planning.* Logistical planning is centralized in specialized staff elements at all echelons of command.

- *Command Control.* Within each echelon, logistics is regarded as a function of command.

- *Standardization.* Considerable effort has been made to standardize weapons and equipment in order to simplify and facilitate maintenance, repair, and supply of spare parts.

- *Distribution Forward.* The control of supply and service support is from higher to lower echelon, with transport and delivery responsibility resting with the higher echelon.

- *Rail Transport.* Rail transport is used to the maximum to conserve stocks of motorized transport and POL reserves.

- *Salvaged and Captured Material.* During combat, recovery, spot repair, reuse of equipment, and the collection and processing of captured material are practiced.

- *Priorities.* Supplies are classified into four categories and priorities are established — ammunition, POL, general (quartermaster, medical, signal, engineer, chemical, and ordinance), and rations.

Division of Responsibilities. The CPLA General Logistics Department promulgates logistical policy for China's Armed Forces and supervises its implementation. At each successive level down to the regiment, a logistics department serves as the supply and service component of the commander's military staff. These departments coordinate and control all logistic support activity including procurement and storage of supplies, medical and veterinary care, transportation, quartering, finance, and salvage.

2. SYSTEM OF SUPPLY

Supply is by forward distribution. Supplies move from factories, warehouses, or arsenals directly to regional depots, then to army, naval, or air force depots, via railway or motorized transport. From depots, supplies reach division supply points by transportation organic to the various units. Supplies are then normally distributed to regiments from division supply points — a main base and three mobile bases — by division transportation. On occasion, supplies are sent directly to regimental dumps to avoid unnecessary handling. Regimental supply points are little more than distribution points where incoming supplies are broken down for redistribution to subordinate units. Regimental transport moves supplies to battalion distribution points,

where they are further broken down for companies and moved forward by an assortment of motorized, animal, or human conveyances. Logistics departments at all levels from regiment upwards may provide additional motorized transport. CPLA transport resources may be further augmented by motor transport, boats, pack animals, or porters contracted or requisitioned from the civilian sector.

SECTION E — PERSONNEL

I. THE CHINESE COMMANDER

a. Status

In keeping with the revolutionary tradition of close relations between commanders and fighters, and in an attempt to offset Soviet-sponsored "professionalism" which was allegedly challenging Mao's "proletarian military line," all ranks and insignia were abolished in mid-1965. The CPLA returned to the pre-1955 practice of referring to officers (leaders or commanders) by job title or position (for example, company commander) and referring to soldiers as fighters. Although the abolition of ranks was essentially one of several steps taken by the Chinese leadership to insure the CPLA's political and ideological loyalty, in addition it demonstrated, at least theoretically, the equal status of officers and enlisted personnel in China's Armed Forces. Post-Mao military modernization and professionalization proponents, however, have argued in favor of the reinstatement of ranks.

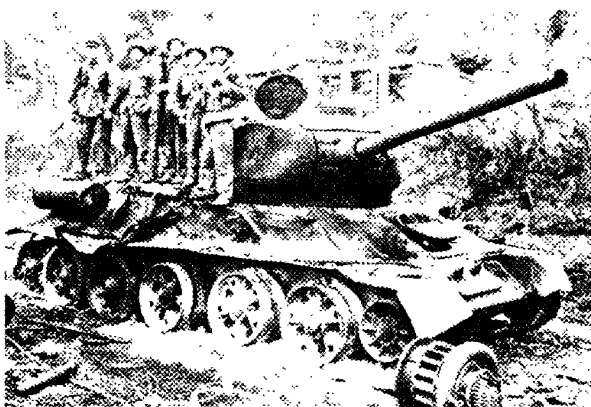

Antitank Platoon with Destroyed Vietnamese Tank, 1979.

b. Officer Selection

In the past, most commanders were chosen directly from the ranks, with ideological correctness weighing as heavily as prior education or proven military ability. Since 1978, however, an increasing number of college graduates have been inducted, especially in technical specialties, and graduates of

senior middle schools have taken examinations for direct admission to military academies. A conscript with the right qualifications, as determined by his unit's CCP branch, could expect to attain the position of platoon leader after 5 years of service. Officer training is conducted at military region schools or academies. Most officers assigned to research or technical positions are trained at military technical institutes. Officer training programs at civilian colleges are not known to exist. Prior education and technical aptitude are likely to prove more significant in the future both for selection and promotion of officers.



Training the Younger Generation.

c. Military Education

As described above, the military education of the majority of Chinese commanders begins with the training the individual receives while in the ranks. On selection to commander status, an individual's military education is likely to include:

(1) Basic officer training at branch or service schools, or at technical institutes which are subordinate to the military regions, fleets, or air districts. Training at these schools can last up to 4 years and produces company-level officers.

(2) Intermediate-level training at schools referred to as "Military and Political Schools for Cadres." Also subordinate to the military region, these

schools reportedly offer instruction to middle-grade officers (battalion/regiment) in political philosophy, Maoist military thought, strategy, tactics, techniques, and armaments. Length of schooling is unknown.

(3) Training at national-level schools. These consist of all major officer schools, various technical schools, and political academies. An example of a national-level school is the CPLA Military and Political College in Beijing. Its students represent the ground, Navy, and Air Forces, study politics, military affairs, and culture, and engage in agricultural and industrial work. Attendance at the Higher War College is considered to be the apex of the individual's military education.

d. The Life of the Commander

The life of the Chinese commander, particularly that of a company-level cadre, is probably not unlike that of officers in other armies. He provides leadership, conducts training, supervises unit activities, and manages the affairs of both the unit and the individual soldier. Unlike other army officers, however, he maintains a rather close relationship with the ordinary fighter, having himself come up from the ranks. Despite higher pay and other benefits derived from his status, the commander, at least theoretically and politically, is the equal of the troops he commands.

e. Conditions of Service

Pay. Officers (commanders and political commissars) receive a monthly salary that reflects the position occupied and total years in service. The current Chinese pay system lists 24 pay grades from student to national-level cadre. The following is a partial list of estimated pay scales in 1973:

Pay Grade	Position	Basic Monthly Pay*	(US \$ Equivalent)
1	Vice Chairman, Military Commission	475 yuan	(\$242.25)
4	Military Region Commander	350 yuan	(\$178.50)
11	Army Commander	225 yuan	(\$114.75)
13	Division Commander	190 yuan	(\$ 96.90)
15	Regiment Commander	160 yuan	(\$ 81.60)
19	Battalion Commander	130 yuan	(\$ 66.30)
21	Company Commander	75 yuan	(\$ 38.25)
23	Platoon Leader	50 yuan	(\$ 25.50)
24	Student/Officer Trainee	45 yuan	(\$ 22.95)

* Estimated monthly basic pay including longevity increments.

Leave. Bachelor officers are entitled to 15 days of leave every 2 years as are married officers accompanied by their dependents. Married officers unaccompanied by dependents are granted 30 days of leave annually.

Promotion. Promotion within the CPLA depends on military competency and political reliability; because there are no ranks it would be a pro-

motion in position, for example, from deputy battalion commander to battalion commander. Career progression, however, normally remains in either the military command or political fields. Crossovers to the other field may occur at the higher levels of command, but are exceptions to the rule.

Retirement. A commander's age, his record, and his future potential, as well as the needs of the service, are all considered when a decision is made to retain him on active duty or separate him from the military. There is no known annuity-type military pension system. At the time of separation or retirement, a one-time cash bonus is made based on the number of years served and the monthly base pay for the position held at the time of discharge.

Work after retirement. Retired officers, if physically fit, may take administrative positions in local government or state-owned industries, often in urban areas. Allocation of such posts is controlled by local CCP committees. These are very desirable jobs in China and, to the extent that they are available, provide an alternative to a formal pension system. Retired commanders may also serve as militia cadres. Under current professionalization programs, older commanders are being encouraged to retire in order to make room for younger, better educated officers.

f. Combat Efficiency

One of the major concerns of the Chinese military leadership today is how the present generation of junior leaders will perform in combat. Although the military training, physical conditioning, and political orientation of today's young CPLA officer is considered sound, his grasp of tactics, technical proficiency, and ability to lead and inspire troops remain untested in modern warfare. He is constantly reminded of the CPLA's revolutionary traditions and is encouraged to emulate veterans whose military careers spanned decades of incessant combat against the Japanese, the Nationalists, and in Korea. While most senior commanders are experienced veterans and are considered efficient and capable in both tactics and command, their mid-level successors have had very limited combat experiences.

2. THE CHINESE SOLDIER, SAILOR, AIRMAN

a. Profile of the Chinese Soldier

The majority of soldiers in China have traditionally been drawn from rural areas, which include over 80 percent of the population. The average soldier is a hard, willing worker and is able to survive and improvise under a wide variety of conditions. He has sufficient education to read and understand simple training manuals. While he may

fall below Western standards in literacy and technical proficiency, he surpasses the average Western soldier in his ability to bear extraordinary hardships. His physical condition is considered excellent. Pervasive and continuous indoctrination from an early age has instilled in him national pride and party loyalty. He has a strong sense of obedience and under competent leadership will attempt to carry out his mission, regardless of obstacles or consequences. The Chinese soldier is considered one of the most highly motivated soldiers in the world today. The prominence and respect which the Armed Forces have enjoyed since 1949 have enhanced the prestige and social standing of the soldier and have overcome the traditional contempt for military life of earlier eras.

b. Ranks

In 1965 all military ranks in the Armed Forces were abolished in an attempt to close the gap between officers and enlisted men. Now only one basic distinction is made in the CPLA: that between "commanders" (officers) and "fighters" (enlisted personnel). Military professionalization proponents in post-Mao China, however, have called for the re-institution of military ranks.

c. Morale

A standard of living well above that of the average civilian, special privileges (openly referred to as "preferential treatment"), and an enormous gain in social status have all contributed to good morale in China's Armed Forces. Morale, however, often tends to rise and fall with fluctuations in the economy and the political climate.

How the Chinese fighter would behave under conditions of modern warfare today is unpredictable. The Chinese "volunteers" who crossed the Yalu River into Korea in October 1950 were highly motivated, highly disciplined troops, instilled with the belief that their technical inferiority could be offset by pitting superior numbers against superior firepower. Constrained by fixed battle lines and confronted by growing casualties, the Chinese realized that masses and sheer determination were not a good match for a professionally trained, well-equipped, and technologically superior enemy. Chinese POWs confirmed that combat morale, discipline, and political control crumbled as a result of the adverse conditions of modern combat. Whether or not the "Korean experience" would repeat itself today is debatable.

d. Conscription and Recruitment

China's conscription law stipulates that all male citizens who attain the age of 18, irrespective of nationality, race, occupation, social background, reli-

gious belief, or education, have the obligation to serve in the Armed Forces. "Counterrevolutionary" elements, landlords and bureaucratic capitalists, and those who have been deprived of political rights are not qualified to serve. The sick or disabled and "compassionate exemptees" (persons who provide sole support for a family, or a family's only son) may be exempted or deferred. Of the estimated 9 million males reaching induction age annually, some 60 percent fail the medical examination while an additional 20 percent are eliminated following an examination of their political backgrounds. Further physical and political testing results in no more than 10 percent of those initially eligible being actually inducted into the CPLA. Induction normally takes place during the slack period in agriculture, generally from November to February. As a practical matter, conscripts are usually sought from among those with at least middle school education and from among the ranks of the militia. The emphasis on modernization has generally led to greater recruitment efforts in the cities. Recruitment for the Navy is likely to take place in coastal, riverine or port areas where local youths already have some acquaintance with maritime affairs. Urban areas, with their higher percentage of educated youths, are the more likely areas for Air Force recruitment because of the more sophisticated needs of that service.

e. Terms of Service

Since 1978 the normal duration of military service for the Chinese conscript has been 3 years for ground force fighters, 4 years for the Air Force, land-based Navy units, and specialized technical units of the ground forces, and 5 years for shipborne units of the Navy and shipborne detachments of the ground force.

Prior to demobilization, a fighter possessing certain technical skills or engaged in special duties may volunteer for extended service. In general, volunteers serve 15 to 20 years to a maximum age limit of 40 years. Should the service require it and the troops themselves desire, the term of service can be further extended. It is estimated that personnel on extended duty comprise about 20 to 25 percent of the PLA's total strength.

f. Demobilization

On completion of military service, most enlisted personnel return to their homes. Local CCP committees make efforts to provide ex-CPLA personnel with vocational training and job placement. In the countryside, many CPLA veterans move into low-level administrative positions, and if they have not already joined the CCP, are likely candidates for

admission. The chance for such mobility has been a major incentive for rural youth to join the CPLA. Demobilized soldiers are required to join local militia organizations. The militia is officially described as "a great military reserve of the motherland whose members have been well trained militarily." Although China does not have a formal reserve system in the Western sense, it is considered to have an effective military manpower reserve pool in the militia. Little is known of the procedures governing the mobilization of these reserves in the event of war.

g. Training

Preconscript Training. Although China has no formal preinduction training, all Chinese youths receive rudimentary drilling and quasi-military instruction in communes and schools. In addition, the "everyone a soldier" movement has provided young people with an ideological orientation for future military service.

Basic Training. Basic training usually lasts 3 months and normally takes place at regimental level in temporarily formed training units. Basic training is rudimentary, consisting largely of political lectures, drill and marching, use and care of individual weapons, bayonet practice, and some tactics. Following basic training the soldier is integrated into a regular unit where he receives advanced individual training. From this point, training becomes the responsibility of the service or arm to which the soldier is assigned.

Those selected for the Navy become naval recruits and assume, for the first time, a strictly naval identity. They are then sent to one of the naval schools or shore commands for further training. A similar routine is followed for Air Force and Missile Force recruits.

Daily Training Program. The basic idea behind the daily training program is to keep the conscript busy from dawn to dusk. A typical daily training program might be as follows:

Activity	From	To
Reveille		0600 hours
PT / Drill	0615 hours	0700 hours
Washing / Bed Making	0700 hours	0715 hours
Morning Meal	0715 hours	0800 hours
Training	0800 hours	1200 hours
Midday Meal / Rest	1200 hours	1330 hours
Training	1330 hours	1730 hours
Evening Meal / Rest	1730 hours	1900 hours
Political Training	1900 hours	2000 hours
Individual Tasks / Study	2000 hours	2100 hours
Lights Out		2100 hours

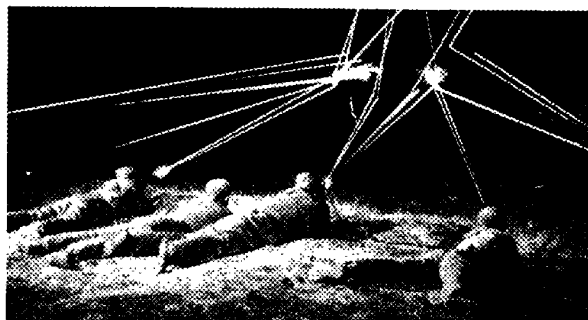

Night Firing Practice.

h. Conditions of Service

Pay. Commanders receive a monthly salary whereas enlisted personnel are given a monthly "allowance" on the theory that soldiers are obligated to serve the state and should not be compensated for their services. This "basic pay" for both commanders and fighters reflects the responsibility and authority of the position occupied and length of service. In addition to the "basic pay," soldiers stationed in remote areas of China (for example, Tibet, Xinjiang), garrisoned on offshore islands, or aboard ships at sea receive an extra monthly allowance. Military personnel with more sophisticated training and duties are thought to be paid higher monthly amounts.

The following chart lists the estimated basic monthly pay for enlisted personnel in the CPLA in the late 1970s:

Years in Service	Monthly Position Pay	Basic	(US \$ Equivalent)
1	Conscript	7 yuan	(\$3.42)
2	Fighter	8 yuan	(\$3.51)
3	Deputy Squad Leader	9 yuan	(\$4.40)
4	Squad Leader	11 yuan	(\$5.38)
4 +	Deputy Platoon Leader	Increased by 5 yuan each year after 4 years in service	(\$2.45)

Rations and Messing. Rations in China's Armed Forces are considered superior in both quality and quantity to that of the average citizen. Most of the meats and vegetables are produced on unit farms. The following is an example of a typical daily menu in the CPLA:

- morning meal — some type of grain (rice, wheat or maize), root vegetables, peppers, eggs, buns, tea.
- midday meal — grain, soup, vegetables, noodles or bread, meat or fish, tea.
- evening meal — grain or noodles, soup, root and green vegetables, peppers, meat or fish, tea.

The CPLA has no known C-ration type meals.

Leave. The CPLA has a very strict leave policy. Conscripts are not normally entitled to leave, except for compassionate reasons. After their initial year of service, all soldiers receive a minimum of 7 days of annual leave, with married soldiers not accompanied by dependents eligible for 15 days of leave. Soldiers on extended service (more than 3 years) are allowed a 20-day home leave each year.

In addition to annual leave, 2-day holidays are celebrated on each of the following national holidays: Spring Festival (the Lunar New Year), Army Day (1 August), and National Day (1 October).

i. Discipline

From its early days as a guerrilla force, the CPLA operated under what were called the *Three Main Rules of Discipline* and the *Eight Points of Attention*, which were memorized by all recruits. The *Three Main Rules* are: obey all orders; do not take a single needle or piece of thread from the masses; and, turn in everything captured. The *Eight Points* are: speak politely; pay fairly for what you buy; return everything that you borrow; pay for anything that you damage; do not hit or swear at people; do not damage crops; do not take liberties with women; and, do not ill-treat captives.

Punishment. In 1981, China's National People's Congress passed a supplement to the Criminal Law of the People's Republic of China setting standard punishments for CPLA members on active duty. Violations include using firearms, betraying or stealing state secrets, desertion, allowing people to cross the border illegally, maltreating or persecuting subordinates, hindering by force or threat of force the performance of duties by others, stealing weapons or equipment, spreading harmful rumors, abandoning the wounded on the battlefield, disobeying orders, making false reports, surrendering

to the enemy, plundering civilians, and maltreating captives. Penalties range from death to imprisonment for 3 years or less, and penalties are more severe in time of war. Minor offenses (theft, gambling, failure to care for equipment) are usually dealt with at company-level criticism meetings. The meetings are attended by the comrades of the delinquent and presided over by the deputy commander or political officer of the company. The soldier is expected to confess his crime, admit his errors, and promise to reform. The group discusses the offense and decides an appropriate penalty.

Court Martial. Major offenses (murder, robbery) are brought before military region courts martial. It is the military court which has the authority to expel a soldier from service, sentence him to prison, or order him executed. The exact composition of the court is unknown. It is normally presided over by an officer whose position is equivalent to that of a US brigadier general. There is neither a prosecutor nor defender. Since there is no known manual on military law equivalent to the *US Uniform Code of Military Justice*, it is believed that military courts generally follow the same legal principles and procedures as do their civilian counterparts.

j. Day Rooms

Each company has its own day room, sometimes referred to as a leisure or reading room. It is used by the soldiers in their free time and usually has ping-pong equipment, newspapers and periodicals, and a selection of approved books. These rooms are similar to the "Lenin Clubs" which were established during the early revolutionary period and which served as the center of all social and cultural life in the unit. Besides serving as a library and ping-pong parlor, the early Lenin Clubs often doubled as dining halls and classrooms.

CHAPTER 2

GROUND FORCES

SECTION A — ORGANIZATION

I. BACKGROUND

The present structure of the ground forces reflects operational concepts which envision large numbers of divisions being employed in conjunction with vast paramilitary forces in the defense of China against an all-out attack. Although predominantly infantry, the ground forces include tank, artillery, anti-tank, antiaircraft, and engineer units.

The ground forces consist of combat, combat support, and combat service support units in 200 + divisions and 200 + independent regiments of all types. The main combat power is found in the 130 to 140 regular main force divisions (115 to 122 infantry, 12 to 15 tank, 3 airborne), and in the 50-odd smaller size border defense, garrison, and internal defense divisions. The 30 + artillery divisions (field artillery and antiaircraft), together with engineer, signal, antichemical regiments, and smaller units, provide combat support. The combat service support motor transport regiments and other logistical-type units balance out the ground forces.

Subordination to Military Regions. Territorially, China is divided into 11 military regions (see map, figure 1). The commanders of these military regions have operational command operations of most ground forces in their geographical areas.

Strength and Mobilization. The Chinese ground forces, consisting of some 3,250,000 troops, remain the largest element of the military establishment. This total does not include the militia.

While no specific plans are known, it appears that Chinese mobilization is based on the militia which has as one of its roles the provision of a reserve of trained manpower for the Army. The militia also maintains a pool of labor for logistic purposes.

2. REGULAR GROUND FORCES

The regular ground forces of the CPLA are divided into two general categories: main forces and local forces.

The largest CPLA tactical formation is the army. The standard army has three infantry divisions, one artillery regiment, and other supporting troops totaling about 45,000 troops. A Chinese army equates approximately to a US corps.

The organizational structure of an army is depicted in appendix B.

a. Main Forces

Main forces (sometimes referred to as field armies) are those regular army troops under the strategic command of the CPLA Headquarters. Main force units are intended to be available whenever necessary for operations anywhere in China. They consist of combat units, combat support units, and combat service support units.

(1) Combat Units

Combat units in the CPLA consist of infantry, airborne (under the Air Force), tank, and cavalry.

Organizational structures of combat units are depicted as follows:

Infantry Division	appendix C
Infantry Regiment	appendix D
Infantry Battalion	appendix E
Airborne Division	appendix F
Tank Division	appendix G
Tank Regiment	appendix H
Mechanized Infantry Regiment	appendix I

Although the Chinese consider cavalry (horse or camel) a combat arm, its employment is restricted to reconnaissance and screening missions over terrain that precludes the use of vehicles. In addition, cavalry units may still provide some flank security during tactical operations, and conduct border patrols, usually along China's northern frontiers.



Infantry and Tanks in the Assault.

(2) Combat Support Units

Combat support units are of the following types: artillery, engineer, signal, and antichemical warfare.



Figure 1. Military Regions.

DOB 2680-32

Artillery. The term artillery, as used by the Chinese, includes field artillery, antiaircraft artillery, and antitank artillery, as well as rocket launchers and mortars. Organizational structures of artillery units are depicted as follows:

Artillery Division appendix J
Antiaircraft Artillery Division appendix K

Engineer. Engineer units in the CPLA are basically of two types: independent and organic. Independent engineer regiments are controlled at army and/or military region level. Engineer battalions are organic to armies and to both infantry and tank divisions. Companies are organic to airborne divisions and infantry regiments. The organizational structure of an engineer regiment is depicted in appendix L.

The pontoon bridge regiment is an independent engineer unit attached to an army or higher level unit which is engaged in river-crossing operations. It is one of several types of independent engineer units which perform specialized roles, such as tunneling, road building, or mine warfare. The organizational structure of a pontoon bridge regiment is depicted in appendix M.

Signal. The organizational structure of a signal regiment is depicted in appendix N.

Antichemical Warfare. Antichemical warfare units are organic to units from armies down to regiments. Some independent antichemical warfare units do exist. As their name implies, their primary orientation is defense against chemical, biological, and radiological (CBR) attack. Their limited offensive capability includes procurement, storage, and distribution of CBR agents; the dissemination of smoke, incapacitating, and lethal agents by various means; and the tactical use of flamethrowers.

(3) *Combat Service Support Units*

Combat service support units in the CPLA are limited to motor transport. The CPLA Railway Engineer Corps was transferred to the Ministry of Railways in 1983.

Motor Transport. Motor transport units in the CPLA are subordinate to the logistics departments of army and division headquarters and the logistic services offices of regiments. There are also several independent motor transport regiments. The organizational structure of a motor transport regiment is shown in appendix O.

b. Local Forces

Local forces, also known as regional forces or local defense forces, are those regular troops of the CPLA stationed in and assigned the task of defending a particular locale or geographic area of China. They are responsible for the immediate defense of

China's coastal areas and land frontiers and, in addition, share responsibility for the internal defense and security of China. Local forces are normally under the command of the headquarters of the military region in which they are stationed.

There are three distinct types of local force units in China: border defense units, internal defense units, and garrison units.

(1) *Border Defense Units*

Border defense units, as the name implies, are those local forces stationed along and responsible for the defense of China's border areas. Essentially a lightly armed infantry force, border defense troops would provide early warning of border violations and constitute the first line of defense in the event of a border incursion. The largest organized unit of the border defense forces is the division. It is somewhat smaller than the standard Chinese infantry division. The organizational structure of a border defense division is depicted in appendix P.



Cavalry Patrol.

(2) *Internal Defense Units*

Internal defense units are lightly armed infantry forces. In peacetime their primary responsibility is the maintenance of law and order in the localities to which they are assigned. In the event of war they are believed to be capable of conducting limited defensive and guerrilla-type operations. The organizational structure of an internal defense division is depicted in appendix Q. These units are presently being transferred to public security departments as part of the People's Armed Police Force.

(3) *Garrison Units*

Garrison units are those local forces tasked with the defense of China's coastal area. They are deployed in static, reinforced, artillery-heavy positions along the coast and on many of the offshore islands, and critical inland defensive positions. Tailored to suit the mission and the topography, they have few infantry troops and possess minimal mobility.

The organizational structure of a garrison division is depicted in appendix R.

3. **PARAMILITARY FORCES**

China's principal paramilitary forces consist of the people's militia, the Production and Construction Corps (PCC) and the People's Armed Police. Although these forces are capable of providing significant guerrilla and/or logistical support to the regular armed forces in the defense of China, none of these groups could make a substantial contribution to the offensive ground capability of the regular forces.

a. **The Militia**

China's primary paramilitary force is the militia, a part-time body controlled jointly by the CCP and the CPLA. The militia is a major component of the people's war doctrine, and, although it is being restructured and reduced in size, it continues to occupy a key role in "people's war under modern conditions." In time of war the militia would cooperate closely with regular units. Its major functions would be to supply reserves for mobilization, to provide logistical support to the main forces, and to conduct guerrilla operations against an invader's supply lines and rear areas. In peacetime the militia conducts military training and provides an example of dedicated effort in agricultural and industrial production.

Militia units are organized in villages, towns, factories, and cities, and the majority of the adult population are nominal members. The militia is divided into three categories: ordinary, basic ("backbone" or "primary"), and armed basic ("armed backbone" or "combat"). Members of the ordinary militia receive little if any training, and this organizational entity is of little military significance. The basic militia, a much smaller force, enrolls politically reliable men and women from 18 to 35 years of age. The armed basic militia is an elite subcategory of basic militia and contains a high proportion of ex-servicemen. They mount armed security patrols and play a significant part in border surveillance. Estimates of militia strength vary: the armed basic militia numbers between 4 and 6 million troops, and the basic militia from 15 to 20 million troops.

Overall responsibility for militia training rests with the provincial military district, and is carried out through subordinate military subdistricts and their people's armed forces departments, control of which is shared with local CCP branches. Militia weapons consist primarily of small arms and mortars, but some units, especially in the urban areas, are equipped with anti-aircraft and antitank artillery. The primary responsibility of urban militia units is air defense, though they also are trained to fight in built-up areas. Workers with special skills may be employed in specialized militia units, so that chemical factory workers would comprise an anti-chemical warfare militia detachment and electronics factory workers a signals unit.

Since Mao Zedong's death in 1976, the Chinese have discussed reform and reorganization of the militia, intended to produce a smaller but better trained militia. Suggested reforms included reducing the categories of militia to two, ordinary and basic; reducing the number of militiamen and disbanding some units; simplifying administration; and changing the militia into a military reserve system. If the proposed reforms are effected, the result will be a militia system that more closely resembles other nations' military reserve systems.

The probable militia organization is depicted in appendix S.

b. **The Production and Construction Corps (PCC)**

The PCC is a paramilitary organization under joint government, party, and military control which has the missions of land reclamation, agricultural production, and economic development in remote and unproductive frontier areas, and border defense. The corps traditionally has had close ties with the CPLA. It was formally taken over by the CPLA during the Cultural Revolution and organized into agricultural and engineering divisions, regiments, battalions, and companies with its members considered CPLA personnel. In the mid-1970s, the PCC was returned to civilian control and its members, many of whom are demobilized soldiers, converted back to civilian status. The PCC is most important in the Xinjiang Uyghur Autonomous Region where it was "revived" along more standard military organizational lines in 1982. It now operates under the leadership of the Xinjiang government and party organizations, the Ministry of Agriculture, Animal Husbandry and Fishery, and the Urumqi Military Region.

The PCC plays a significant role for the CPLA, providing food and logistical support to local units in remote frontier areas. The PCC's armed basic

militia units also serve as border defense forces and probably would be more militarily effective than most regular militia units in time of war.

The probable organization of the Xinjiang PCC is shown in appendix T.



Army-Militia Joint Patrol.

c. People's Armed Police Force

The Chinese People's Armed Police Force was established in 1983 by merging CPLA units which guarded leading party and government departments and key installations, with armed and frontier police as well as fire brigades formerly under the leadership of the public security departments. The decision to do so was in part related to the CPLA "regularization" drive. Sizable numbers of demobilized CPLA personnel have been absorbed by the People's Armed Police Force.

The People's Armed Police Force has a national command headquarters in Beijing and provincial and municipal headquarters throughout China. It is organized along standard military lines with commanders, deputy commanders, commissars, chiefs of staff, and so forth. The People's Armed Police Force is directly subordinate to the Ministry of Public Security and, at the time of its inauguration in 1983, the Minister of Public Security served concurrently as the chief political commissar of the police force.

There is a close relationship between the CPLA and the People's Armed Police Force. The armed police maintain the system of integrating compulsory and voluntary military service, follow CPLA rules and regulations, and use the CPLA supply standards. According to official reportage on the newly established police force, the People's Armed Police are to be given the same status as the CPLA and "like the CPLA, the people's armed police is the people's own army under the party's leadership."

The new People's Armed Police Force is similar to that established after establishment of the PRC in 1949. The former armed police force incorporated CPLA public security units and, prior to the Cultural Revolution, was under the Ministry of Public Security. During the Cultural Revolution the armed police were disbanded and their internal security and border guard functions were taken over by CPLA and militia units. In 1980, frontier armed police units were reestablished, a move leading to the establishment of the People's Armed Police Force in 1983.

SECTION B - COMMAND AND CONTROL

1. ORGANIZATION OF HEADQUARTERS

The highest known current Chinese headquarters in the field is the army. It is probable, however, that in wartime, for span-of-control purposes, these armies would be controlled and coordinated by a senior headquarters called the Army Group (sometimes referred to as Army Corps). Army Groups in turn would be controlled by the Front Armies.

The main sections of a Chinese army headquarters are:

- *Operations Department.* The Operations Department is controlled by a chief of staff who is responsible for the operational direction of subordinate units in accordance with the commander's plan. This department includes subordinate sections responsible for operations and training, personnel, security, artillery, armor, engineers, chemical warfare, communications, and reconnaissance.
- *Political Department.* The Political Department deals with all political as well as security and propaganda matters. It is also responsible for all aspects of the soldier's welfare, and together with the Operations Department, for the interrogation of prisoners of war. All matters related to civilians, including the Communist Youth League, are dealt with by this department.
- *Logistics Department.* The Logistics Department is responsible for all aspects of logistic support. It is

divided into ordnance, quartermaster, finance, and services sections and is supported by a medical and a transportation battalion.

- *Party Committee.* See chapter 1.

The organization of the division headquarters is similar to that of the army headquarters.

2. FORMATION COMMANDERS

At each level, the military commander and the political commissar share joint responsibility for combat operations, for all administration and for the general military and political training of all assigned troops. There are various tasks assigned to the commanders at each echelon.

- *Army Group Commander.* The Army Group Commander is concerned with the conduct of the entire operation in which his group is involved and with long-term strategic planning.
- *Army Commander.* The Army Commander receives his tasks from the Army Group. His main concern is the conduct of operations in his area over a short-term period.
- *Division Commander.* The Division Commander is concerned primarily with the day-to-day situation as it affects his division.

3. LOCATION AND MOVEMENT OF HEADQUARTERS

Each headquarters is divided between forward and rear command posts to insure continuous activity by the three staff departments.

The *forward command post* is organized into combat, signal, and service groups. The latter group includes administrative, mess, and medical personnel from the Logistics Department. The commander, political commissar, and most of the Operations Department comprise the combat group of the forward command post.

The *rear command post* is commanded by the chief of the Logistics Department and includes most of the staffs of the Political and Logistics Departments.

The commander will decide where the command posts are to be established and the axes on which they will move. The location of the headquarters will depend on the level of headquarters and the tactical situation. Army headquarters will generally be sited in depth in order to maintain control over its entire area. Division and regimental headquarters will be located well forward in order to maintain control of the battle.

4. ORDERS AND INSTRUCTIONS

The means by which a commander controls his forces will inevitably depend to a certain degree on his own personality and methods. Normally, detailed planning for tactical operations is carried out at

army level. These plans direct the specific actions of units two or three echelons below the planning headquarters. Specific reactions to possible enemy actions are preplanned. Deviations from the plan may be made only within prescribed limits.

Planning during operations takes the form of continuous refinements of the tactical plans made before the initiation of the operation. This is done at planning conferences by the commander and his staff (including the political commissar) on a daily basis prior to each day's operation.

Following the daily staff planning conference, the army Operations Department prepares and disseminates combat orders and instructions to subordinate units. These instructions are limited to those which implement decisions that change the existing plan. They are dispatched several hours before the operation is to be resumed to afford subordinate commanders ample time to put them into effect.

Based on the army orders and instructions, the division commander formulates his general plan and issues detailed orders often including specific locations of key points within designated regiment and battalion areas.

SECTION C — EQUIPMENT

A general discussion of CPLA equipment was presented in chapter 1, section C. Those generalizations are also applicable to the ground forces equipment in terms of shortages in equipment, parts and skilled mechanics to maintain and repair the equipment. The CPLA intends to modernize its ground forces equipment inventory based on the principles of simplicity and operational flexibility.

Despite the CPLA's adoption, since the 1950s, of traditional Soviet-style tables of organization and equipment and the more recently adopted combined-arms concept of armor and artillery-heavy mobile forces, the ground forces still have significant long-term requirements for large quantities of small arms and light vehicles. However, the conditions of modern warfare are recognized by China as including heavy use of large, highly mobile armored forces, long-range artillery, and combined ground and air operations. To counteract such a threat, the CPLA is seeking to increase its inventory of antitank weapons, armored personnel carriers, tanks, and antiair weapons, either through domestic production or foreign purchase.

Technical details, illustrations, and quantities of common Chinese ground forces equipment are given in appendix U.



Rocket-Propelled Grenade Launcher-Mounted Infrared Sighter

SECTION D — TACTICAL PRINCIPLES

In chapter 1 it was explained that China's strategic military doctrine is defensive in nature. Very little is known about offensive doctrine for the employment of the CPLA outside Chinese borders. Chinese doctrine emphasizes the destruction of invading enemy forces, rather than the capture and retention of terrain. However, the Chinese would probably defend certain key political and industrial areas in the more conventional positional-type defense.

The Chinese are capable of undertaking any type of conventional operation. They are also capable of fighting, to a limited extent, in a nuclear environment. Although China is believed to have the technical capability to produce tactical nuclear missiles, it is not known whether they actually possess such missiles.

While conventional operations are constantly conditioned by the threat of the imminent use of nuclear weapons, Chinese tactics at the lower level vary little in either case. The major difference is that on a nuclear battlefield there will be much greater dispersal of forces.

1. ECHELONS

Units are normally divided into a first and second echelon. The first echelon comprises the leading assault or main defense elements required for the first phase of an operation. The second echelon comprises followup or depth elements required for a subsequent phase or phases.

2. SPECIAL TECHNIQUES

a. Electronic Warfare

The Chinese have a limited ability to employ

electronic support measures such as intercept and direction finding, and electronic countermeasures such as jamming and deception. The Chinese have undoubtedly gained a considerable amount of practical experience in electronic warfare from the conflict in Indochina during the 1965-72 period.

b. Chemical Warfare

By Western and Soviet standards, the Chinese have a comparatively limited capability to employ chemical agents. They have the ability, however, to disseminate incapacitating and lethal agents by aircraft spray, bombs, and shells. In addition, it may be assumed that the Chinese are developing modern agents to add to their stocks of older toxic and non-toxic agents.

The Chinese have the ability to offset the likelihood and effects of a chemical strike on them through the employment of equipment that is at least adequate to their needs. The actual depth of such necessary stocks of antichemical warfare devices and their dissemination to the troops is not fully known.

In addition to its lethality, chemical attack poses two further problems for friend and foe alike:

(1) The exhausting effect on those compelled to wear protective masks and full protective clothing for long periods.

(2) The considerable time necessary to decontaminate equipment before it can be used.

Reportedly, efforts are being made to train Chinese troops so as to minimize both of these problems. How widespread, intensive, and effective this training is remains unknown. The chemical, biological, and radiological (CBR) capability of the CPLA ground forces is at the development level, and continuing improvement in both defensive and offensive capabilities is to be expected.

Special antichemical units, responsible primarily for decontamination, are organic to the army down to division level. The basic unit is the antichemical company composed of these platoons:

- Equipment Decontamination Platoon,
- Personnel Decontamination Platoon,
- Reconnaissance and Observation Platoon,
- Smoke Platoon, and
- Flamethrower Platoon.

SECTION E — MANEUVER

The CPLA is predominantly an infantry force; its tactics accordingly are designed to exploit the capabilities of the infantry. This factor, together with its historic guerrilla warfare background, has made it capable of relatively good tactical mobility in terrain which is difficult for highly mechanized forces.

Movement on foot is fast, and a rate of 40 kilometers a day can be maintained by large forces over great distances in open terrain when unopposed. China's serious shortage of trucks, APCs, and tanks, however, provides the CPLA with a rather limited overall mobility. Under combat conditions, such as those experienced in the 1979 Vietnam invasion, such a rate of march would be unattainable.

Chinese tactics, as in other armies, are based on fire and movement. In addition, the Chinese endeavor to retain freedom of maneuver sufficient to envelop enemy positions as well as to attack them frontally. It is most unlikely, however, that "human wave tactics" of the Korean War pattern will be employed without considerable refinement.

The Chinese emphasize depth in attack and are quick to take advantage of a penetration of their opponent's forward defenses and to develop it by seizing objectives behind his main position.

Guerrilla warfare remains an important part of Chinese military doctrine. Teaching emphasizes the importance of substantial forces infiltrating the opponent's flanks and rear before an assault. These forces establish themselves astride their opponent's supply routes to prevent reinforcement or withdrawal of the defending force and to prevent employment of reserves.

1. IN THE ATTACK

a. Objective

Units are given initial and subsequent objectives:

An *initial objective* is taken by the first echelon.

A *subsequent objective* may require committal of the second echelon and normally coincides with the initial objective of the next higher headquarters.

Commanders choose tactical objectives which will help destroy the opposing forces. These objectives will normally be enemy positions, particularly on vital ground, whose seizure would facilitate future operations or offer the greatest opportunity to destroy the defenders.

b. Rate of Advance

Despite increases of motorized transport throughout the CPLA, the Chinese infantry moves primarily on foot; other elements move by organic transport regiments. The rate of advance on foot can be surprisingly rapid — about 5 kilometers an hour or 40 kilometers a day. In addition, forced marches are carried out if the Chinese think they can thereby outflank the enemy and either cut his lines of communication or attack him from the flank or rear. To achieve this, the Chinese do very detailed planning with emphasis on:

- rapid and bold offensive action,

- maintaining the momentum of the advance by night and day,
- traffic discipline and strict control of movement, and
- organization of forces to permit rapid deployment and commitment.

c. Night Operations

CPLA doctrine stresses the importance of night operations. The Chinese are expert in both combat and administrative operations under cover of darkness. In fact, virtually all movement and the majority of operations occur at night. They do this to avoid sustaining heavy casualties from enemy air action and to achieve tactical surprise. By marching only at night and concealing all troops and equipment during the day, they have demonstrated the capability to shift large forces without detection. During the later stages of the Korean War and in the Sino-Indian campaign of 1962 and the border war with Vietnam in 1979, night movement became the general rule.

2. IN THE DEFENSE

In Chinese tactical doctrine all defensive operations are planned and conducted with the aim of changing over to the offensive as quickly as possible. To the CPLA the only true defense is active defense, also called "offensive" or "decisive engagement" defense. Passive defense — simply resisting the enemy with no thought of shifting to the offense — is disparaged.

The CPLA will fight a defense in place only when they must protect a vital area. Prolonged positional defense is contrary to Chinese military thinking since it is static rather than dynamic and is relatively costly in men and materiel. The CPLA prefers, whenever possible, to draw the enemy in and wear it down while preparing to shift to the offensive. Even when holding a fixed position CPLA doctrine stresses the importance of the counterassault, which is defined as "an assault carried out within tactical limitations against an enemy who has broken through the lines." The counterassault elements endeavor to attack the enemy's flanks and rear, wipe out the enemy force with concentrated fire and bayonets, and regain their position.

The CPLA prefers a mobile active defense, which it considers part of "mobile warfare." The goal in mobile defense is to promote the dispersal and disorganization of enemy forces, which will then be worn down by sudden, short attacks on targets of opportunity until the CPLA can launch an offensive. While yielding territory, Chinese forces attempt to break up enemy combat formations and to inflict maximum casualties, often by sudden attacks from concealed positions.

3. OBSTACLE CROSSING

Both infantry and engineers are trained in improvised methods of obstacle crossing. The Chinese make the most of locally available material. A common technique is the use of submerged bridges or fords built below water level at a safe vehicle wading depth. They are difficult to detect even by close observation. The Chinese capability for crossing obstacles is described under the phase of war in which it is generally employed. Minefield breaching and water and gap crossing are described later in this chapter.



Approaching the Enemy Position.

SECTION F — OFFENSIVE OPERATIONS

1. DOCTRINE

The fundamental Chinese military doctrine is that victory can be won only by attacking. This doctrine applies at all levels.

Moreover, the Chinese believe that victory can be achieved only by striking in selected areas with overwhelming numerical superiority. A ratio of 3 to 1 is considered the minimum, but much higher ratios of even 10 to 1 are preferred. This concentration of force occurs only in the area of the proposed assault and the Chinese are quite prepared to draw down other sectors to achieve this imbalance.

2. APPLICATION

a. Basic Tactical Maneuvers

The Chinese Army, as with all conventional armies, employs two distinct offensive tactical maneu-

vers: envelopment in its various forms and frontal attack.

Envelopment. This maneuver can take either of the following forms:

Double Envelopment. Elements of the attacking force engage the enemy in the main defensive position to neutralize their small-arms fire and force them to disclose their mortar and artillery defensive fire tasks. The remainder of the assaulting force divides and simultaneously attacks around both flanks to cut off the enemy force and thereby prevent reinforcement or withdrawal. The encircled force is then destroyed.

Simple Envelopment. The main assault is on one flank only; otherwise, the aim and the method of execution are the same as for the double envelopment.

Frontal Attack. The frontal attack is employed by the Chinese only when their forces enjoy numerical superiority (at least 3 to 1) and no gaps can be found in the enemy flanks or rear, and maneuvering along the FEBA has failed to develop a gap in the enemy defenses. The assault is launched on a narrow front with the aim of breaking through the enemy FEBA, thereby permitting successive assault waves to pass through and fan out within and behind the defensive positions.

A frontal attack combined with an encircling movement is called a penetration-envelopment maneuver. (See figure 2.)

b. Tactical Techniques

The Chinese use simple catch phrases to describe various tactical actions. Examples are "one point, two sides" and "divide and destroy."

One point, two sides is a variant of the envelopment in which the enemy's weak spot is attacked simultaneously with feints and enveloping movements. "One point" means the concentration of overwhelmingly superior strength and attack at a selected weak point. "Two sides" means the launching of an attack where two or more supporting attacks are necessary to insure that the enemy can be enveloped and annihilated. This does not mean that the attack is limited to only two sides. When strength permits, attacks on three or more sides may be launched. (See figure 3.)

Divide and destroy is a principle applicable at all levels and is an alternative to the "one point, two sides" tactic. As the words imply, the Chinese attempt to penetrate the enemy position and to split the defenders successively into smaller groups; then they assault to annihilate by overwhelming forces. (See figure 4.)

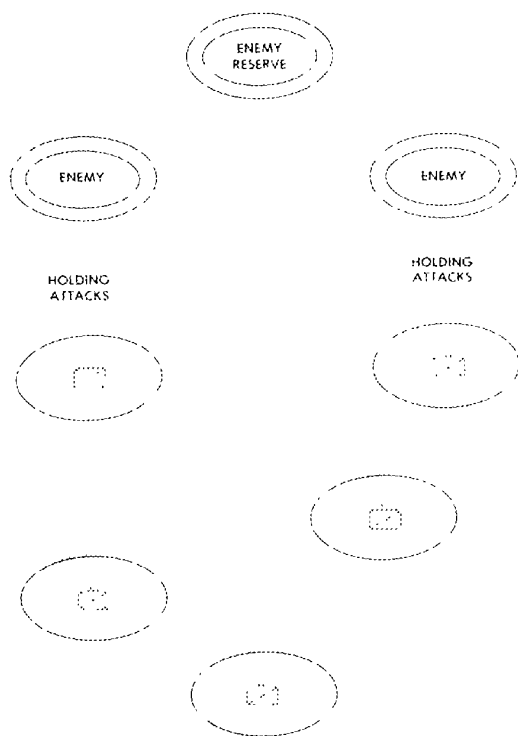

Figure 2. Penetration-Envelopment Attack.

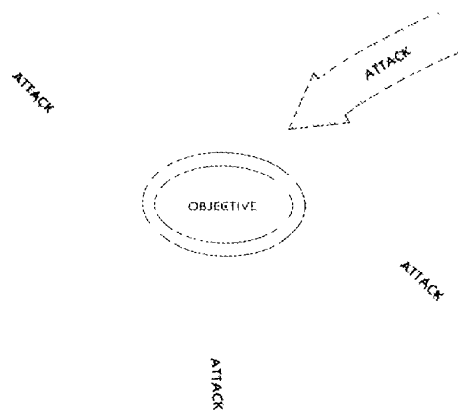

Figure 3. One Point, Two Sides.

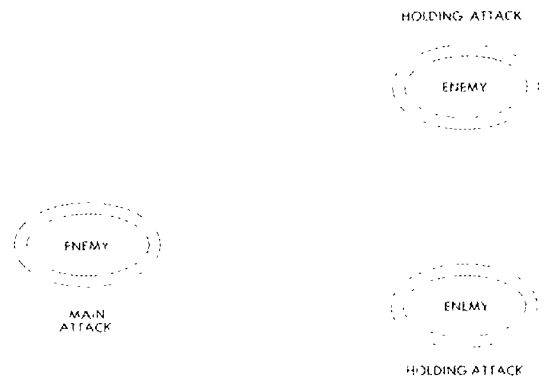

Figure 4. Divide and Destroy.

3. BASIC PRINCIPLES

The Chinese in all their tactics make the maximum feasible use of the following basic principles:

Speed. In the offensive, the continuous development of the attack at high speed is mandatory. The division usually is assigned an initial, an intermediate, and a subsequent mission, all to be accomplished within the first 24 hours of the operation. Successive echelons follow up and exploit any successes, thereby maintaining the initiative and momentum of the attack.

Secrecy. Secrecy is maintained in the preparation for the attack and every effort is made to surprise the enemy as to the time and place of the attack.

Infiltration. Long experience in guerrilla warfare has made the Chinese masters of the art of infiltration. Their teaching emphasizes the importance of infiltrating substantial forces around the enemy's flanks and rear prior to an assault. The forces endeavor to prevent reinforcements to or withdrawal of the defending forces prior to their destruction by the main attack.

Night Operations. The majority of all tactical operations occur at night.

All Chinese offensive actions are divided into four basic attack phases (see figure 5). They are as follows:

The Approach March. The move from the assembly area to the attack position.

The Attack. The move from the attack position to the assault position.

The Assault. The move from the assault position until the initial objectives have been secured.

Combat in Depth. This phase begins as soon as the initial objectives are secure. It may be started by the first (or assault) echelon when it is still an effective force or by the second (or support) echelon.

One or more of the following echelons are employed to carry out and add weight and depth to the attack:

- first or assault,
- second or support, and
- third (usually only when attack is on narrow front).

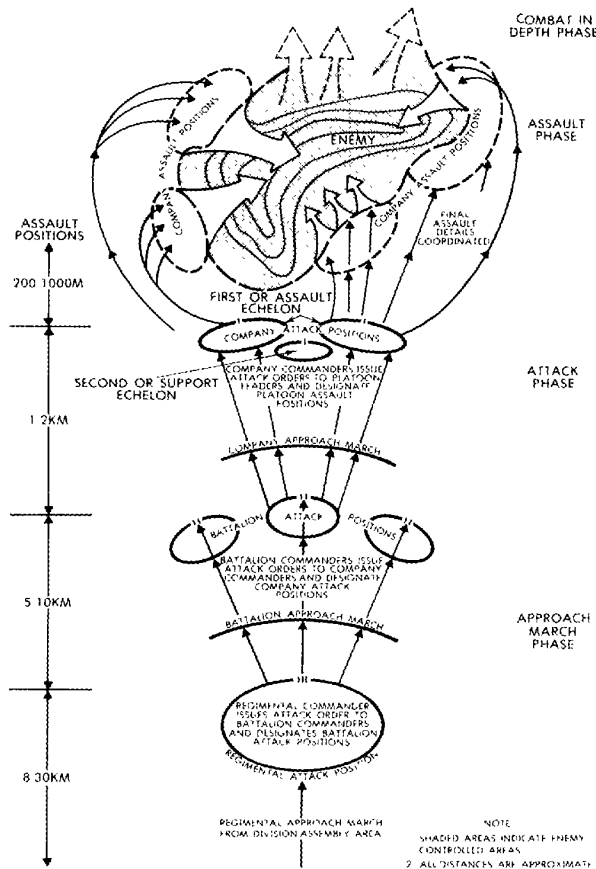

Figure 5. The Attack.

The Chinese do not categorize the reserve as an echelon in the offense. The second or support echelon is tasked to follow and support the assault echelon in the attack and is therefore committed. This echelon is not a proper reserve although it may be assigned missions such as repelling counterattacks which are normally given to a reserve. The reserve proper varies in strength according to each combat situation.

A guide to the size of the reserve is as follows:

Division — battalion in reserve

Regiment — company in reserve

Battalion — normally do not have a reserve.

4. FRONT,¹ ARMY GROUP, AND ARMY OFFENSIVES

The aim of front, army group, and army offensives is to break through the various echelons of the enemy's main defenses. The offensive employs one or more forms of the envelopment to isolate and destroy the main body of the enemy and, whenever possible, engage his reserve. If the situation precludes envelopment, multiple penetrations of the defensive position are made, followed by envelopment. At army level, the Chinese are capable of reaching objectives as far as 20 to 25 kilometers behind the enemy FEBA in a single night. Attacks at these levels are normally carried out in three echelons consisting of forces of roughly equal strengths; the echelons are assigned attack, support and reserve roles, respectively. In practice, however, an army may be committed in its entirety and backed by reserve armies available to the higher headquarters.

The size of the sector and the depth of objectives allocated to a front or army group vary considerably depending on its strength, role, the terrain, and whether or not the campaign is nuclear.

Typical measures for the army and subordinate units in offensive operations are shown in the following table:

Frontage and Depths in Offensive Nonnuclear Operations*						
	Army**	Division	Regiment	Battalion	Company	Platoon
Frontages						
Sector	16-40 km	8-12 km	3-4 km	1-2 km	300-500 m	..
Attack Frontage	4-8 km	2-4 km	1-2 km	500-750 m	250-350 m	100-150 m
Depth of Objective						
Initial	10-15 km	3-5 km	2-3 km	1-2 km
Subsequent	30 km	10-15 km	3-5 km	2-3 km
Depth of Operations	35-40 km	20-25 km
Rear Boundaries From FEBA	30 km	15 km	6 km	3 km

(This material is based on earlier data and is probably being changed.)

* In nuclear operations all distances would be modified.

** An Army Group is thought to consist of three armies.

¹ A front is a geographical entity which comprises an indeterminate number of army groups or armies depending on the assigned mission.

Airborne Operations. A front normally is allocated an airborne regiment or battalion. Recent military exercises have stressed the use of both paratroops and helicopters in an assault landing role in the context of a combined-arms operation, in which infantry, armor, artillery, airborne troops, and ground support aircraft coordinate their efforts.

5. DIVISIONS, REGIMENTS, AND BATTALIONS

a. The Advance

A division in a movement to contact (see figure 7) deploys in the following components and is encountered by an enemy in this order:

- motorized reconnaissance elements,
- the advance guard consisting of point, advance party, and advance guard proper, and
- the main body.

Motorized reconnaissance elements are employed on the divisional routes from the division and regiment reconnaissance company and platoon, respectively.

The advance guard or first echelon of the division is normally a combined-arms force whose size and composition vary. The following may be used as a guide:

- When a division moves in a column, the advance guard is based on an infantry regiment.
- When a division moves in parallel columns, each leading regiment is responsible for its own security. In such a situation, the division advance guard is, in effect, a reinforced infantry battalion along each route.

The main body or second echelon advances with the headquarters, artillery, and air defense elements well forward.

Flank and rear guards are established by the division as a whole, and by each march echelon on a small scale. They are composed of all arms and their size and composition depends on the possible enemy threat. They are normally mounted and move along parallel routes, about 10 kilometers from the main body, to give early warning of enemy intentions, to prevent direct fire on the main force, and to give the commander freedom of movement. These guards, like the advance guard, deploy with:

- a point,
- a flank (or rear) party, and
- a flank (or rear) guard proper.

Antitank Defense. The Chinese disperse their organic antitank resources, including artillery, throughout the various march echelons to blunt and stall an enemy armored attack until other elements of the division are able to mount a counterattack. In addition, armor and artillery are allocated to the advance guard whenever possible. Recent training exercises have featured rocketlaunched antitank

mines. The purpose of the mines is to block the tanks' advance and immobilize them so that they can be destroyed by artillery and antitank missiles.

Antiaircraft Defense. In operations against a major foe, the Chinese know that they will not have air superiority. As a consequence, their doctrine includes specific passive and active procedures against air attack. Moving and fighting at night combined with careful attention to camouflage and concealment minimize the threat of air attack. Additional antiaircraft weapons from the army level frequently augment organic antiaircraft units which are deployed under divisional control throughout the echelons to achieve a limited defense against air attack. Training exercises have displayed mobile surface-to-air missile units, radar-controlled antiaircraft guns and radar jamming and electronic countermeasure detachments, but such modern devices are not yet available to most CPLA armies.

Summary of Leading Components. The possible order and grouping in which leading Chinese combat vehicles may be encountered by a defending force are given below. Not exhaustive, the following is intended only as a guide:

Vehicles	Role in Attack
Light tank Types 62 or 63, APC (Type 63), Motorcycle with sidecar.	When first seen are divisional reconnaissance.
Motorcycle with sidecar, individual trucks and small parties of infantry.	Regimental reconnaissance
Company of infantry with additional heavy weapons. Possible three medium tanks	Point of advance guard
Six to 10 medium tanks, battery of artillery, battalion of artillery, battalion of infantry and engineer vehicle	Advance party and may be some elements of the main guard.

Routes. A division is allotted up to five routes and a regiment up to three. The Chinese will sacrifice depth to gain a broad front. In fact, by moving large bodies of troops along minor tracks, the Chinese have often outflanked and outwitted their enemy.

b. The Attack

Types of Attack. The Chinese ground forces recognize three different types of attack which affect their tactics at division level and below:

- *The Meeting Engagement.* Logically following the advance, it is a collision between opposing forces on the move and usually takes place before either force is fully deployed.
- *The Hasty Attack.* Whenever possible, it is conducted from the march. Its purpose is to penetrate thinly occupied and hastily prepared defensive positions by rapid deep thrusts, disrupting the entire defensive system.
- *The Deliberate Attack.* It requires careful planning and a relatively long period of preparation, and is mounted against a well prepared defense.

Figure 6 is a schematic diagram of a Chinese division deployed in a movement to contact.

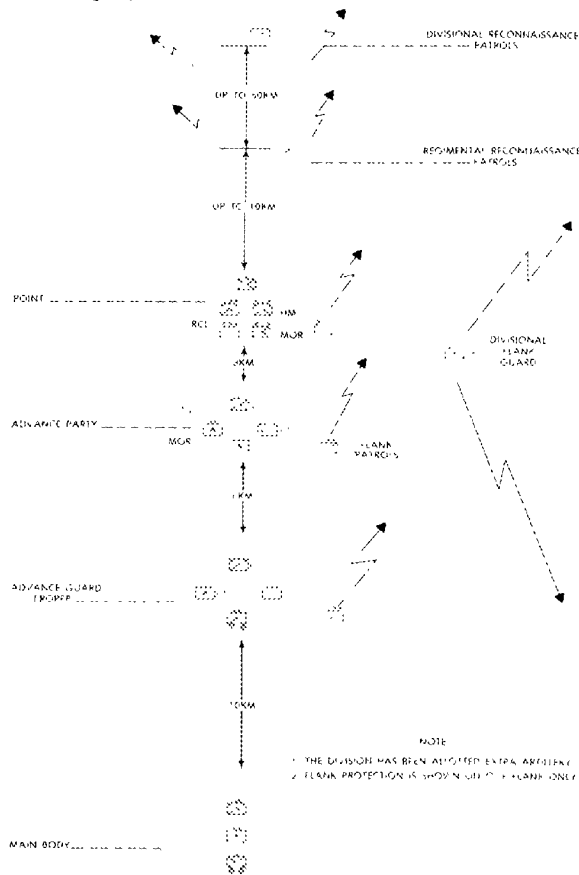

Figure 6. The Movement to Contact and Meeting Engagement by an Infantry Division.

Action by the Advance Guard. On contact, the point, consisting of a reinforced company, engages the enemy and attempts to destroy or contain him. If the point and advance party cannot overcome the resistance, they quickly dig in and engage the enemy while the advance guard proper (one regiment minus) attacks on one or both flanks to encircle and destroy the enemy or force his retirement.

The advance guard commander deploys his force on a wide front to seek the best avenue of approach to the enemy's flanks. The advance guard action is often a piecemeal operation, units being allotted tasks and launched into action as they become available. These rapid piecemeal attacks are part of the reconnaissance effort to define the enemy's FEBA, to locate weapon and gun positions, and to determine defensive fire tasks.

Action by the Main Body. The division commander, from the information gained by the advance guard, deploys the main body as soon as

possible to carry out an enveloping attack to annihilate the enemy.

If the enemy withdraws before encirclement is complete, he is pursued.

Rapid and bold offensive action is considered the key to success and envelopment is considered the best method of isolating and annihilating portions of the enemy column. The division commander, having allotted his commanders their tasks, places greater reliance on their initiative and judgment in the meeting engagement — and in the pursuit that may follow a quick success — than in the more deliberate phases of war.

Tanks in the Advance. The proposed role of armor, based on the terrain, determines its positions in the advance. Tanks, however, are normally allocated to the advance guard to support the infantry in its operations.

The commander husbands his armor carefully and is unlikely to commit his tanks until the enemy tank strength has been reduced by artillery and antitank fire. Tanks are then massed in the main attack to destroy the remaining enemy tanks and strong points and to pursue the withdrawing forces.

Artillery in the Advance. The role of artillery is to deliver fire and pin down enemy forces as soon as they come within range, and to counter flank attacks.

Artillery units are deployed well forward in the advance to exploit the maximum range of the guns. On contact with the enemy, artillery units with the advance guard go into action as rapidly as possible. Direct fire, including tank fire, constitutes a considerable portion of the initial support until artillery with the main body is able to reinforce the fire of the advance guard.

Chinese doctrine stresses that artillery must be able to support the infantry and army as they commence their attacks.

Minfield Breaching. Engineers organic to the division and regiment clear or supervise the clearing or breaching of obstacles and minfields on the scale of three lanes per attacking rifle company.

Mine detectors and probes are used for mine detection. Mines are neutralized and removed for use elsewhere, although attempts may be made to detonate antipersonnel mines on the spot using long bamboo poles with hooks. Bangalore torpedo-type devices are also used.

Minfields may also be breached by using mine ploughs or in difficult terrain by mine plough/roller combinations. Both are fitted to the front of tanks.

c. The Hasty Attack

The hasty attack is made against an enemy occupying a hastily prepared defensive position. The

Chinese consider that such a position is unlikely to have a fully coordinated defensive plan and that its fire support will be relatively poor.

The Chinese emphasize speed in the planning, preparation, and execution of the attack consistent with an adequately coordinated fire plan. The "one point, two sides" tactical technique (a main attack with simultaneous diversionary attacks) is normally used. The principle of this technique has been described above.

Infantry Division. The deployment of the division depends on the strength of the enemy. If the strength of the enemy is unknown, the infantry division attacks with two regiments in the first echelon and one regiment in the second on a frontage of about 6 to 7 kilometers. If the enemy is weak, three regiments may be deployed in line for the attack. If the enemy is strong the division is deployed in the three echelons with one regiment in each echelon.

Infantry Regiment. In this case the first echelon usually consists of two reinforced battalions and the second, of one battalion. The attack frontage is about 3 kilometers.

Infantry Battalion. The battalion attacks on a frontage of about 700 meters with two reinforced companies in the first echelon and one company in the second.

Tanks in the Assault. All available tanks are placed under command of the unit carrying out the attack. Tanks are normally massed and deployed in the front of the first echelon.

Fire Support. Fire support is described in section F of this chapter. A quick conventional fire plan is drawn up while the infantry moves into attack positions. This allows for the employment of divisional artillery and infantry mortars.

d. The Deliberate Attack

The deliberate attack against a well-organized defensive position is characterized by careful planning, increased reconnaissance activities, and the deployment of numerically superior forces against specific positions. In fact, a Chinese infantry division may be employed against a battalion position or a battalion against a platoon.

Army. This formation may carry out an attack either independently or as part of an army group. The attack frontage is believed to be about 8 kilometers and its initial objectives are about 10 to 15 kilometers deep. Final objectives may be up to 30 kilometers.

Infantry Division. The division, usually controlled by army, attacks on a 2 to 4 kilometer front, normally in two echelons. Initial objectives are 3 to 5 kilometers behind the enemy FEBA and final objectives may be up to 10 to 15 kilometers. If the attack

is on a narrow front, the Chinese may use three echelons.

Infantry Regiment. The division commander may use one or more of his infantry regiments to try to outflank and encircle the enemy. The regiment attacks in two echelons, the first consisting of two reinforced battalions, the second, one battalion, on a frontage of up to 2 kilometers. Objectives are allocated only to the first echelon battalions; the second echelon follows the first echelon and is usually given missions of mopping up bypassed centers of resistance. Both echelons are considered to be committed.

Infantry Battalion. The battalion normally attacks in two echelons in a manner similar to the regiment.

Rifle Company. The company is considered to be the smallest force capable of using the "one point, two sides" and "divide and destroy" techniques. It often attacks in two echelons, but it can attack in one. Orders are usually very specific and give the company commander little scope for independent action.

Tanks in the Assault. Tanks, when available, are normally placed under operational control of the regiment, which in turn allocates them to the leading battalions in the first echelon of the attack. Tanks are massed to assist the infantry's advance into the depths of the enemy's defense. It is unusual for tanks to be used in smaller than company strength (10 tanks).

Fire Support. At least one of the division's organic artillery battalions, consisting of three batteries, is normally placed in direct support of each of the first echelon regiments.

Artillery from army resources give additional fire support to the attacking regiments.

Artillery is usually in position at least 24 hours before an attack. Preliminary ranging may well reveal Chinese intentions.

An example of a fire plan of a deliberate attack is as follows:

Time (minutes)	Artillery Fire	Action by Assaulting Troops
H-68 to H-67	Rapid and concentrated neutralization.	Move to line of departure completed by H 15.
H 67 to H-43 H-43 to H-33	Destruction. Howitzers stop firing; guns and mortars continue.	
H-33 to H-8 H-8 to H-1	Destruction. Howitzers fire in depth; guns and mortars continue.	
H-1 to H+1	Rapid and concentrated neutralization	Infantry assault preceded by tanks at H hour.
H+1	Neutralization barrage extended in depth. Ranging for defensive fire tasks.	Assault

Direct fire from field and antitank guns often supplements the fire plan just prior to and during the assault. In addition, 5 minutes before the assault, known enemy positions are engaged by all other weapons within range, including small arms and recoilless rifles.

Battalion Attack. As part of a regimental attack, the pattern of a typical deliberate attack might be as follows:

- Battalion in divisional assembly area approximately 8 to 30 kilometers behind the FEBA at H minus 2 days.
- Battalion moves to the regimental attack position under cover of darkness some 5 to 10 kilometers behind the FEBA at H minus 1 day.
- Battalion moves to its attack position some 1 or 2 kilometers behind the FEBA, at H minus 9 to H minus 2 hours, where it organizes into its assault formations (two companies up, one back).
- The assault echelon, which must be established within 750 to 1,000 meters and under cover of artillery and battalion supporting weapons, then moves forward in close formation (usually arrowhead) to the company assault positions within 200 meters from the objectives.
- At this point the platoons, with each of their squads divided into three teams, advance in a skirmishing formation with 3 to 5 paces between individuals and 7 or 8 paces between teams. They follow their own artillery concentrations very closely and are prepared to suffer some casualties in order to take maximum advantage of their own fire.
- Depending on the terrain, the tanks time their movement to get ahead of the infantry in the assault.
- The assault is made in a continuous rush. As soon as the squads are within range, handgrenades are thrown to cause confusion, smoke, dust, and casualties. As the squads reach the enemy positions, all members fire their weapons and close with the enemy to destroy him at pointblank range.
- On clearing the objective, the assault force continues its attack and exploits beyond the objective while the support echelon consolidates on or near the objective. If the assault echelon has suffered heavy casualties, exploitation is carried out by the support echelon.
- The Chinese reorganize rapidly and are formidable diggers. Under reasonable conditions, a battalion can, in one night, dig in and provide overhead protection to a depth of 18 inches.

e. The Pursuit

The pursuit starts when the enemy either is routed or attempts to break contact in a preplanned withdrawal.

When it becomes apparent through intensified reconnaissance that the enemy is planning or has just begun to withdraw, an attack is launched immediately to confuse him and disrupt his plans. Once it is clearly determined that a withdrawal is in progress, pursuit is initiated. All available units are committed immediately, piecemeal if necessary, to insure that contact is maintained with the retreating enemy. Once initiated, pursuit cannot be terminated except on orders from a higher headquarters.

Pursuit Tactics. In the pursuit, close and continuous pressure on the enemy is considered necessary to prevent his regrouping or reassuming the defensive. As soon as possible, the Chinese form two or more columns, one to exert direct pressure and the other(s) to move on either flank parallel to the withdrawing enemy in an attempt to overtake, encircle, and then destroy him.

The flanking columns are organized from units of the support echelon and the reserve. They are often motorized and reinforced with tanks if available. Speed is emphasized and enemy strongpoints are bypassed so that critical road junctions and defiles on the enemy withdrawal routes can be seized and defended.

SECTION G — RECONNAISSANCE

1. MEANS OF RECONNAISSANCE

The CPLA inferiority to Western and Soviet forces in certain technological support aspects such as air, mobility, fire control, and surveillance equipment, as well as its concern for obtaining overwhelming local tactical superiority, leads to its insistence on detailed reconnaissance.

The following excerpt from CPLA regulations indicates the importance placed on reconnaissance by the Chinese:

Every commander must organize reconnaissance within his unit's zone of activities. He must not wait for instructions from his superior, nor must he seek his superior's decision as to whether he should organize reconnaissance. The reconnaissance he organizes must be carried out without cessation to comply with the combat mission through each successive period and phase of combat. Each new mission requires immediate organization of reconnaissance. The conduct of continuous reconnaissance during combat is vitally important.

The main Chinese means of reconnaissance are:

- *Air reconnaissance.* This is one of the main sources of combat intelligence.

- *Patrols and raids.* Units from army down to battalion have their own specially trained reconnaissance subunits.
- *Observation.* In both defensive and offensive operations, a system of fixed observation posts is established. At night, listening posts are set up to augment other early warning security measures.
- *Motorized reconnaissance.* Special units at the army level and in infantry and tank divisions provide limited motorized reconnaissance.
- *Artillery observation,* including field radars.
- *Electronic intercept and direction finding.* It is presumed that the Chinese have a limited capability in this area, but the degree of development is not known.

a. Air Reconnaissance

(1) Method

Reconnaissance missions are probably carried out at altitudes between 1,000 and 6,000 meters at speeds of 400 to 500 knots. The pilot can report targets directly by radio or relay his reports.

Modern Chinese aircraft are capable of photographic reconnaissance in addition to the normal method of visual reconnaissance by the pilot.

At night, aircraft would operate at a higher altitude and at a reduced frequency.

Search and destroy operations may be carried out by pairs of aircraft on reconnaissance missions.

(2) Reaction Time

Targets found by photo reconnaissance. Although some very limited capability probably exists through rudimentary satellite surveillance, photo reconnaissance is largely accomplished by aircraft. Photo interpretation is probably not up to current Western and Soviet practice.

(3) Scale of Effort

Because of the limited number of fighter and medium-range bomber reconnaissance aircraft, it is not possible to estimate a daily sortie rate. The tactical air forces, however, are thought to work in direct support of the ground forces.

b. Patrols and Raids

In all phases of war the Chinese patrol energetically and skillfully. These patrols are always specially equipped for their tasks and a high proportion of automatic weapons are carried.

In addition, the Chinese occasionally employ soldiers in civilian clothes or enemy uniforms for reconnaissance purposes.

Reconnaissance activities by day or night are often increased prior to an offensive. Patrolling is directed to every part of the front in order to discover avenues of approach, enemy positions (in particular, enemy headquarters), and any weak

points. Reconnaissance activities may include:

- feints to induce the enemy to disclose his position,
- raids in strength to test enemy reactions and to secure prisoners, and
- strong, limited attacks, particularly when the enemy's strength is undetermined.

c. Motorized Reconnaissance

Scale and Employment. The army and its infantry and armored divisions have special reconnaissance units equipped with light amphibious tanks, armored cars, and motorcycles with sidecars which may operate from 8 to 20 kilometers ahead of the main body. Local civilian transport may be impressed for use should it be necessary. This practice was used during the 1979 Sino-Vietnamese conflict.

There are also special reconnaissance elements from engineer, artillery, and chemical units.



Motorized Reconnaissance

d. Artillery Observation

Army and division artillery observation units contain:

- surveillance and weapon-locating radars,
- radar intercept/direction-finding sets,
- sound-ranging devices, and
- flash-spotting observation posts.

Figure 7 summarizes the ranges at which the various reconnaissance elements operate.

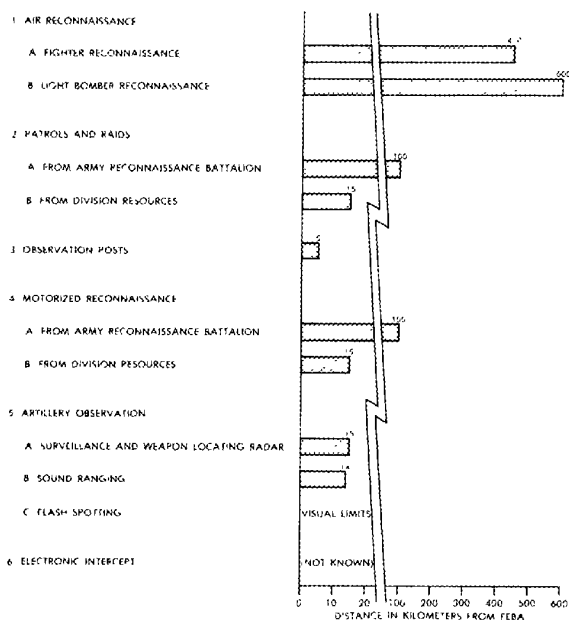

Figure 7. Effective Range of Chinese Means of Reconnaissance.

SECTION H — FIREPOWER

1. CONVENTIONAL ARTILLERY

a. Allocation

In the event of hostilities, it is presumed that independent artillery divisions will be allocated to armies by the Army Group headquarters.

An army normally allocates its own and allotted conventional artillery to first echelon divisions, although an army may on occasion retain some artillery for its own requirements.

A division in turn will allocate some of its organic and allotted artillery to its regiments.

A regiment normally places the artillery received from the division in direct support of its first echelon battalions.

Second echelon divisions, regiments, and battalions may not be allotted direct artillery support until they are committed.

b. Control

Formal fire plans are detailed and meticulous, and control of guns is retained at the highest practical headquarters.

On completion of a formal fire plan the control of artillery units is decentralized to divisions, regiments, and battalions at whatever scale is required for the operation.

Artillery can be organized into temporary tactical groups to provide the fire support required by

the tactical situation. These groups, which are made up of organic and nondivisional artillery, are of the following types:

- *Support groups.* Consist of artillery placed in direct support of infantry regiments. Weapons used normally include 122-mm.
- *Long-range groups.* Composed of heavier artillery, some groups may be allotted in direct support of divisions while others will remain under army control.
- *Destruction groups.* Composed of heavy, high-powered artillery formed for the destruction of obstacles and defenses.

While artillery communications are adequate, a radio link is seldom established with the supporting unit; the Chinese depend instead on the collocation of the artillery commander with the supported commander.

Forward observers are deployed well forward with the front line battalions.



Artillery and Infantry Coordinating Firepower.

c. Deployment

Chinese field and antitank guns, towed by wheeled and tracked prime movers, have a good long-range performance. Guns and howitzers are also considered to be principal antitank weapons. If

the tank threat warrants it, organic artillery will at times be employed in the antitank role. At least 5 percent of all ammunition holdings are antitank. High velocity guns are equipped with armor-piercing ammunition, lower velocity weapons with shaped-charged ammunition.

2. CHEMICAL FIRE SUPPORT

The Chinese possess a variety of means of chemical warhead delivery such as surface-to-surface missiles, rocket launchers, and guns of or above 122-mm. It may therefore be presumed that chemical warheads could be found in their inventory. Information on the actual employment of chemical weapons, however, is limited.

Chemical weapons are particularly suitable for targets where casualties to personnel are required but where damage to the terrain should be minimized. Likely targets and the type of chemical agents are:

- Nonpersistent agents.
 - defiles, river crossings, and communications centers on main axes of attack,
 - airfields and potential dropping or loading zones, and
 - enemy positions close to one's own troops.
- Persistent agents.
 - to restrict the use of ground,
 - airfields which are not in use, and
 - ports, bases, and other rear area installations.
- Nonpersistent or persistent agents.
 - nuclear weapon systems and artillery,
 - well dug-in enemy positions, and
 - headquarters, reserves, and assembly areas.

3. NUCLEAR FIRE SUPPORT

There is no evidence that China possesses a tactical nuclear weapons stockpile or that the CPLA has developed any coherent doctrine for tactical nuclear fire support of ground forces. China's strategic nuclear forces have a deterrent mission and are intended to be used only in retaliation, probably against countervalue rather than counterforce targets. It is unlikely that these strategic assets would ever be used in tactical situations or employed within China to halt the advance of hostile forces. Although China is assessed as having the capability to produce tactical nuclear weapons and has successfully tested nuclear devices in the 20-kiloton range, there is no evidence that it has yet produced or deployed such weapons. Such a policy may have derived from Mao Zedong's conviction that tactical nuclear warfare would quickly escalate to the strategic level. China's limited economic and technological resources, and the political problems arising from regional control of tactical nuclear

weapons also pose difficulties for Beijing. Chinese defense literature has reflected a more receptive attitude toward the advantages of tactical nuclear weapons since the death of Mao; but China is not now assessed as having any stockpile of tactical nuclear rockets, guided missiles, or atomic munitions.

China's ballistic missile force, the CPLA 2d Artillery, is discussed in chapter 5.

4. TANK AND ANTITANK FIRE

a. Indirect Fire from Tanks

If necessary, the CPLA would use indirect tank fire to augment the fire plan in offensive or defensive operations.

b. Antitank Fire Plan

Antitank fire planning is detailed and is coordinated at the highest possible level. Antitank weapons are held by infantry regiments and divisions; armored divisions and independent armored regiments rely on their tanks for antitank fire. Flanks and tank approaches are covered by mutually supporting antitank weapons sited in depth.

c. Antitank Reserves

As the Chinese have incorporated a considerable amount of Soviet doctrine in their tactics, it is assumed that regimental and division antitank reserves are formed in both the attack and the defense. These reserves are probably made up of both guns and tanks, and will generally include an engineer subunit to lay minefields in threatened areas. The role of an antitank reserve is to deploy rapidly to meet tank threats.

d. Equipment

In addition to the battalion weapons (40-mm antitank grenade launchers, 57-mm recoilless rifles), regiments have a 75-mm recoilless rifle company. The artillery regiment has 85-mm guns which can be employed in a direct fire role. The Chinese also have domestically-produced SAGGER antitank guided missiles deployed in special antitank units.

5. OFFENSIVE AIR SUPPORT

Chinese tactical air support to ground forces, compared with Western and Soviet armies, is extremely limited in quantity and quality but has received increased emphasis in maneuvers during recent years.

a. Ground Attack Tactics

At present, Chinese ground attack pilots must make visual, rather than radar, contact with their targets; therefore, they require at least 4-kilometer visibility for the mission to be undertaken.

Aircraft attacking ground targets normally operate in pairs or in multiples of pairs. Attacks can be made with conventional bombs, napalm, cannon, rockets, or chemical warheads. They usually deliver

their ordnance in a dive, although straight-and-level bombing is the normal ordnance delivery made for the larger bomber aircraft.

There is insufficient information to estimate the number of daily ground attack sorties, however, the average would probably not exceed two sorties per aircraft per day.

b. Control

It is assumed that the military region or Army Group Headquarters would normally retain control of tactical air support aircraft, allocating sorties to ground force units as necessary. Air liaison officers and forward air controllers are probably deployed with divisions to coordinate the air support of ground operations. The Chinese are not believed to have a close air support capability in the Western sense of the term, i.e., close coordination between air force units and ground force maneuver units.

c. Targets

The majority of offensive air support is assigned to support ground forces in their combat operations. In general, China uses its tactical air forces as

an extension of tube artillery in providing assistance to their ground forces.

6. AIR DEFENSE

The function of air defense is to provide:

- cover for the Military Region or Army Group through antiaircraft artillery divisions, surface-to-air missile battalions, and organic army antiaircraft resources, in coordination with air defense fighters of the CPLA Air Force;
- point protection by division and regiment air defense weapons; and
- a competent and efficient target acquisition and warning system which provides air defense units with targets, and combat units with warnings of attack. This system, however, consists primarily of older Soviet radars which would have a limited effectiveness against a modern air force.

Targets will be protected in the following priorities:

- nuclear delivery means,
- headquarters, and
- assembly areas.



Air Defense Training

SECTION I — DEFENSIVE OPERATIONS

1. BACKGROUND

The Chinese define the defense as an intermediate stage in the overall, broad offensive aim. It is assumed that the offensive is terminated when there is strong enemy action or if time is required to concentrate forces for the counteroffensive. Defense is regarded as a temporary expedient adopted in order to:

- preserve friendly forces while weakening those of the enemy,
- gain time to concentrate forces for the offensive or counteroffensive,
- economize forces to allow an offensive to be mounted in another area,
- consolidate captured objectives, and
- cover a withdrawal. (See figure 8.)

Chinese defensive postures are based on:

- firmly holding areas of tactical importance with well dug-in troops,
- retaining in the second echelon mobile reserves to block penetrations and to counterattack,
- using all available firepower, and
- making maximum use of both natural and artificial obstacles throughout the defensive area. Defensive positions are normally placed behind natural

antitank obstacles which are improved or supplemented by boobytrap entanglements and antitank and antipersonnel mines.

2. FORMS OF DEFENSE

Broadly, the Chinese employ two types of defense: positional and mobile.

Positional Defense. This is similar to the US concept of the area defense. It is organized in depth and designed to deny vital areas to the enemy or to halt his attack while inflicting significant losses on his men and material. At the same time, this defense permits the massing of Chinese forces for the counteroffensive.

Mobile Defense. This has developed from China's long experience in mobile revolutionary warfare. It is a "hit-and-run" type of defense based on a war of movement. It is conducted as a series of defensive actions followed by controlled movement to the rear, with the aim of inflicting maximum casualties on the enemy without undue loss to one's own forces. The selection of key terrain from which to deliver fire and force the enemy into an unfavorable situation is an important ingredient in mobile defense. Retention of terrain, however, has only a passing relevance or importance. Chinese forces are organized so they can break contact at will, thereby enabling them to continue their stepping-back process until the purpose of the mobile defense is achieved or until they have withdrawn back to an area where the bulk of their forces are deployed in a positional defense role.

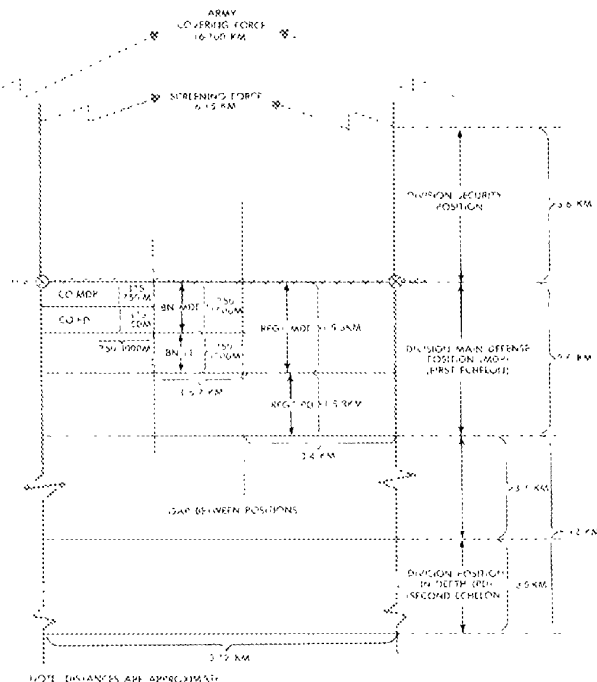

Figure 8. Division Defense Boundaries.



Desert Camouflage.

3. ORGANIZATION FOR DEFENSE

Echelons. At all levels, a commander divides his forces into two echelons for the purpose of defending a given area.

Defensive Areas. The area to be defended by a unit is divided into three positions:

The Security Position. It is occupied by the unit's screening force, its reconnaissance elements, and the security force.

The Main Defensive Position (MDP). The MDP is occupied and defended by the unit's first echelon.

The Position in Depth (PD). The PD is occupied and defended by the unit's second echelon, also considered to be the unit reserve. It consists of the balance of the unit's organic and attached strength. At division level, it also includes the motorized counterattack force normally deployed in assembly areas between the main defense position and the position in depth.

Frontages and Depths. The following table sets forth frontages and depths for various formations. These figures relate to frontages and depths in defense in a main sector. Frontages in subsidiary sections are considerably greater.

	Mobile Defense		Positional Defense	
	Frontage	Depth	Frontage	Depth
Army	32-80 km	Depth varies	16-40 km	40-60 km
Division	16-24 km	too much	8-12 km	9-18 km
Regiment	6-8 km	for average	3-4 km	3-6 km
Battalion	2-4 km	figures	1-2 km	1.5-3 km
Company	1-1.5 km	to be	500-700 m	500-700 m
Platoon	500-700 m	given	250-350 m	250-350 m

(This material is based on earlier data and is probably being changed.)

Deployment.

Army. An army normally deploys two infantry divisions in the first echelon and one infantry division in the second. In a wide subsidiary sector, however, it might deploy three infantry divisions forward.

Division. An infantry division normally deploys two regiments in the first echelon and one regiment in the second. In a subsidiary sector, some or all of the third regiment may be in the first echelon.

Covering Forces. Elements (usually not more than a reinforced regiment) of the army's second echelon or of a tank division attached to the army are normally employed as the covering force in front of the division defense zones. The distance that it operates in front of the FEBA varies from 16 to 100 kilometers and obviously depends on the terrain, the relative strength of opposing forces, and the overall mission of the Chinese commander.

4. THE DIVISION IN POSITIONAL DEFENSE

The infantry division normally participates in defensive operations as part of a larger force (see figure 9). The army commander prescribes the area to be defended by the division and coordinates the

employment of artillery and armor. He also coordinates barrier and denial operations throughout the army defense zone.

The infantry division commander is responsible for the following:

- organizing and defending an assigned defensive zone,
- providing security for supporting arms and services within the zone,
- constructing fortifications to withstand artillery fire and attacks by armor and from the air,
- maintaining the integrity of the FEBA and inflicting maximum casualties on the enemy in front of the FEBA, and
- counterattacking to restore the integrity of the FEBA should a penetration of the FEBA occur or, if this is not possible, containing any penetration of the FEBA until counterattacks can be mounted by a higher headquarters.

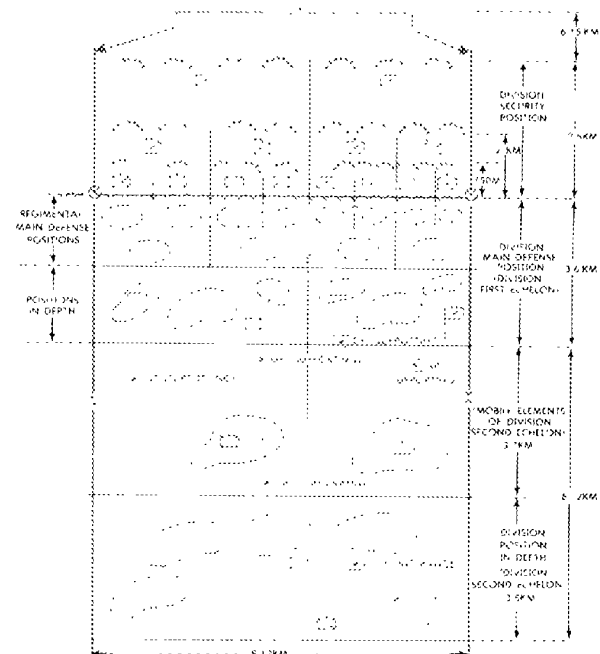

Figure 9. Positional Defense - The Division.

a. Division Defense Area

(1) **Security Position.** The security position is located forward of the main defensive position. It is lightly manned by mobile troops who provide security for forces in the main defensive position.

Screening Force. This consists of the division reconnaissance company. It is deployed 6 to 15 kilometers forward of the main defensive position to provide early warning, to maintain liaison with the

army's covering force, and to determine enemy strength and main axes of advance. It falls back under pressure through the security forces into the main defensive position where it is used to cover gaps, to protect flanks, and to provide rear area security, particularly against airborne attacks.

Regimental Security Force. This force operates some 3 to 6 kilometers in front of the FEBA and is deployed in locations prescribed by the division commander. The force normally consists of one reinforced company from each of the frontline regiment's second echelons. The regiments retain operational control over their reinforced companies. The tasks of the security force are to:

- defend stubbornly if the situation permits;
- engage the enemy at long range in an attempt to force him to deploy prematurely and thereby slow down his advance;
- deceive the enemy as to the strength, disposition, and intentions of the main defensive force;
- maintain contact with the attacking force; and
- protect the main position from surprise attacks.

The Battalion Security Forces. Normally, each battalion is required to provide a reinforced platoon to occupy security positions up to some 2,000 meters in front of the FEBA. Operational control is retained by the battalion commander. Tasks are the same as for the regimental security force.

The Company Security Force. Each frontline company usually provides a reinforced squad to man security positions up to some 750 meters in front of the FEBA. In very close terrain the battalion commander may not order the establishment of such a force. Operational control remains with the companies at all times.

Supporting Fire. Artillery, tank, and heavy weapons fire are carefully coordinated to support the security forces mentioned above.

(2) *Main Defensive Position (MDP).* The bulk of the division is deployed in the division MDP. The position is organized in depth as a continuous defensive belt. This defensive belt is made up of mutually supporting strongpoints or localities employing all-round defense across the entire frontage. These strongpoints are expected to hold out even if bypassed or encircled. Gaps between companies and battalions are covered by observation, fire, and minefields.

Forces:

- in the division MDP --- normally two reinforced regiments,
- in the regimental MDP --- normally two reinforced battalions,
- in the battalion MDP --- normally two reinforced companies,

- in the company MDP --- normally two reinforced platoons, and
- in the platoon MDP --- normally two reinforced squads.

Tasks:

- to organize and defend their assigned sectors,
- to inflict significant losses on the enemy and his equipment in front of the FEBA, and
- to prevent penetration of the FEBA and, should penetration occur, to restore the integrity of the FEBA.

(3) *Position in Depth (PD).* The position in depth is organized in such a way as to stop deep penetration of the defense zone, to provide a firm base to support counterattacks, and to provide rear area security. This organization applies to all units carrying out a positional defense. At division level one regiment normally occupies the PD, the forward edge of which is usually located 6 to 13 kilometers behind the FEBA. The regiment normally organizes the PD with two of its three battalions. Strongpoints are often constructed on the reverse slopes of key terrain features. In addition, blocking positions are constructed. The third battalion of the regiment is usually motorized, forming part of the mobile counterattack force of the PD, and is located between the MDP and the actual PD itself.

Forces:

- in the division PD --- one infantry regiment and one tank regiment minus,
- in the regiment PD --- one battalion,
- in the battalion PD --- one company,
- in the company PD --- one platoon, and
- in the platoon PD --- one squad.

Tasks:

- to organize and defend the PD,
- to provide rear area security,
- to counterattack in order to destroy any enemy penetration and to restore the integrity of the FEBA,
- to contain enemy penetrations, and
- to act as a division reserve.

(4) *Division Antitank Force.* The Chinese may use an artillery support group (possibly battery size) in the antitank role. It is sited to cover the most likely enemy thrusts or to cover a "killing zone" into which enemy armor has been purposely canalized.

(5) *Division Counterattack Force.* The tank regiment minus and one motorized infantry battalion of the division second echelon, which are located in assembly areas forward of the positions in depth, comprise the counterattack force.

(6) *Reserve.* The regiment less one infantry battalion which occupies the PD is also considered the

reserve. If a counterattack by the division counterattack force should fail, the army commander may direct the reserve to be used as a counterattack force. The committal of the reserve may be made only on orders from the army commander.

(7) *Division Headquarters.* A forward command post is established forward of the position in depth. Main headquarters is located behind the division second echelon in the position in depth. Rear headquarters is with the logistics units up to 50 kilometers behind the FEBA. Much of the CBR force and equipment is held at this location.

(8) *Fire Support.* The principles of fire support and the allocation of artillery are described in section F above.

(9) *Fire Plan.*

Nuclear and Chemical. The Chinese are not known to possess tactical nuclear launchers and it is unlikely that they would use strategic missiles in support of ground forces in defensive operations. Chemical strikes, however, would be targeted against communication centers, on likely enemy deployment areas, and to cover any large gaps in the overall defensive concept.

Conventional. Fire planning is centralized, some of it at army level, until the enemy's main attack has begun. It is designed to fulfill three main roles:

- *Counter Preparation.* An elaborate fire plan is made by the army artillery commander. It aims to engage the enemy's batteries and deployment areas as early as possible and to concentrate the fires of all weapons so that the enemy is subjected to progressively heavier bombardment as he approaches the main defensive zone.
- *Defensive Fire.* Linear and area concentrations are planned and registered to cover gaps, likely areas of attack, and possible areas of penetration.
- *Counterattack Support.* Concentrations are planned to support counterattacks.

(10) *Antitank Plan.* The division plan basically implements the army antitank plan employing organic antitank units and those units allotted from army resources. It expands the army's concept to include the manner in which the battalion and sometimes the company organize their antitank defense.

Normally the antitank defense comprises four belts; three belts in front of the FEBA and a fourth in the defense-in-depth position.

- The *first belt* is located in the division security position and is manned by the regimental security force. It consists of antitank minefields and obstacles covered by supporting fire. In addition, special antitank teams organized from the regimental security force are employed.

- The *second belt*, also located in the division security position, is manned by the battalion security force. It is organized in a similar fashion to the first belt mentioned above.

- The *third belt* generally coincides with the belt of final protective fires established by frontline units of the main defensive position. It consists of obstacles and minefields covered by small-arms fire and organic antitank weapons.

- The *fourth belt* is defense in depth. Antitank weapons are sited to cover the main tank approaches and areas into which tanks are expected to be canalized. They are located principally in the MDP and in the area between the MDP and PD.

In addition special antitank teams of three or five men may be formed to seek out and ambush enemy tanks in the main defensive position.

A mobile division reserve of antitank weapons is collocated with the mobile elements of the second echelon in the area between the MDP and PD. Its role is to deploy rapidly to meet and contain enemy tank thrusts.

Antitank guns, recoilless rifles, and artillery employed in the antitank role are usually sited in pairs. These weapons are normally moved after each firing to avoid detection.

(11) *Air Defense Plan.* The air defense plan is coordinated at division level employing regiment and division antiaircraft weapons to protect:

- division headquarters,
- artillery positions, and
- mobile elements of the second echelon and the reserve. In addition, where possible, some antiaircraft weapons are located so as to have a dual but subsidiary role of assisting in the antitank defense.

(12) *Deployment of Division Artillery.* The division commander, through his artillery commander, organizes his organic and attached artillery units into the following groups:

- long-range groups consisting of heavy and high-powered artillery under division control deployed 6 to 10 kilometers behind the FEBA,
- direct support groups deployed 2 to 5 kilometers behind the FEBA, and
- roving artillery groups deployed in the division security position or in alternative positions in the MDP to support the security forces and confuse the enemy.

(13) *Digging.* The ability and the willingness of the Chinese soldier to dig in and construct extensive, elaborate trenchwork are extraordinary. Given time, he will build weapons emplacements and troop shelters that will withstand all but direct hits by conventional weapons.

Infantry. All infantry are dug in a series of interconnecting strongpoints which are organized for all-round defense and are mutually supportive. If time permits, communication trenches and alternative positions are dug laterally between platoons and back to company headquarters. Overhead cover is normally provided for the bunker entrances, troop shelters, individual foxholes, and machinegun emplacements. Camouflage is used extensively to provide concealment.

Tank and APCs. Tanks and APCs are normally dug in. Explosives and dozer blades, if available, are used to assist human endeavor. Camouflage is used extensively.

Artillery. Guns may be dug in. Camouflage is used extensively to provide concealment.

b. Conduct of the Battle

(1) In the Division Security Position

Screening Force. Troops from the division reconnaissance company make contact with the enemy some 6 to 15 kilometers in front of the FEBA. They fall back under pressure without becoming inextricably engaged and pass through the regimental security forces into the division position in depth. Long-range artillery and air strikes are used against reported targets.

Security Forces. After the withdrawal of the screening force, the regimental security force, supported by air and artillery strikes, conducts a stubborn defense. When further resistance is considered unprofitable, the division commander orders a withdrawal through the battalion and company security positions to their respective regimental PDs. As the enemy pressure increases, the battalion and company security forces are withdrawn.

(2) In the Division Main Defense Position

Preassault. An intense counterbattery fire plan, assisted by combat aviation, is fired to preempt, and, if possible, to neutralize the enemy's preparatory bombardment. Likely enemy assembly areas and lines of departure are targeted to disrupt attack intentions. Troops in defensive positions occupy shelters to protect them against nuclear, chemical, and conventional fire. Radio silence is maintained.

The Assault. As soon as the enemy launches the assault on the MDP, fire from all available weapons is brought to bear on the enemy's forces. Infantry heavy weapons and supporting artillery attempt to separate hostile tanks from their accompanying infantry, so that the tanks may be destroyed more easily by infantry antitank teams, and the attack slowed down, if not halted. The first echelon battalions of the frontline regiments in the MDP, in

accordance with doctrine, do not withdraw even if bypassed or surrounded. As enemy penetrations are made, the second echelon battalions of the regiments either launch previously prepared counterattacks in an attempt to destroy the penetration and restore the integrity of the FEBA, or endeavor to contain the penetration from alternate positions prepared in depth.

(3) In the Division Position in Depth

Preplanned counterattacks are conducted at every level should the enemy succeed in breaching the defensive positions. Normally the authority of the next superior commander is required before they can be launched. Counterattacks usually consist of fire from all types of weapons followed by infantry attacking from a different direction. As with their attack tactics, the Chinese usually try to gain surprise with a flank attack while the enemy is reorganizing or counterattacking at night or when visibility is restricted.

At division level two counterattack forces are normally assigned the task of destroying enemy penetrations which have survived various counterattacks delivered by the regiments in the main defensive position. The first force is the mobile combined-arms group of the division's second echelon; it is normally deployed forward of the actual position in depth and is under the control of the division commander. If this force is unsuccessful, the division commander informs the army commander who directs him to commit his entire second echelon either to:

- destroy the enemy penetration and restore the FEBA, or
- strengthen and defend the division PD in order to contain the penetration and cover the withdrawal of the division first echelon.

5. THE MOBILE DEFENSE AT DIVISION LEVEL

Mobile defense is conducted when the terrain on which it is fought is not considered critical, thereby allowing the Chinese to trade space for time (see figure 10). At the same time, the mobile defense enables the Chinese to deploy massive forces to attack the invader. The division participates in the mobile defense usually as part of a larger force. The mobile defense is conducted as a series of defensive battles fought at previously designated lines of resistance forward of a final interception line. It is characterized by surprise, limited counterattacks, and ambushes carried out in strength aimed at inflicting maximum casualties on the enemy, not on the retention of ground.

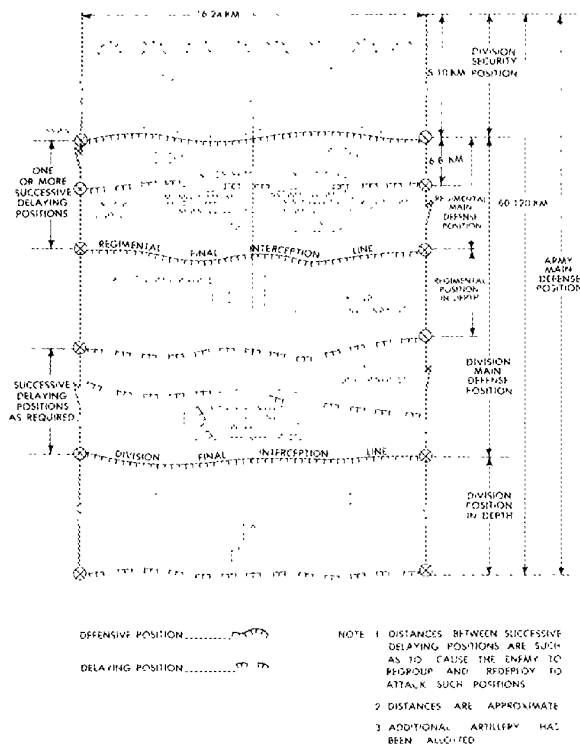

Figure 10. Mobile Defense — The Division.

a. Division Defensive Area

(1) The Security Position

The security force, controlled by the division commander, consists of two reinforced battalions, usually mobile, from the second echelons of the frontline regiments. It operates some 5 to 10 kilometers in front of the FEBA. Its tasks are to:

- maintain contact with the army covering force,
- establish and maintain contact with the enemy after the army covering force has withdrawn,
- determine enemy strength and avenues of approach,
- engage the enemy at long range to force him to deploy prematurely, and
- conduct a delaying action while inflicting the maximum number of casualties on the enemy.

On completion of its tasks, the security force withdraws through the FEBA and the battalions revert to the operational control of their respective frontline regiments.

(2) The Main Defensive Position (MDP)

The division's first echelon MDP is divided into two regimental size elements. These reinforced regiments are deployed abreast in the MDP. The third regiment occupies the division position in depth. Within the main defense positions of subordinate

regiments, battalions, and companies, however, usually a third of the strength constitutes the first echelon with two-thirds held back in reserve. Conversely, firepower is deployed with two-thirds of its strength forward and the remaining one-third in the rear. The regimental MDP itself is organized with a defensive belt across the FEBA with subsequent, preplanned delaying positions to the rear until regimental final interception lines are reached at the forward edge of the regimental positions in depth where a positional-type defense may be conducted. Small-scale defensive battles involving surprise attacks and or withdrawals are fought by combined-arms groups in an attempt to delay, fragment, canalize, and or exhaust superior enemy forces until these forces are susceptible to piecemeal destruction by a major counterattack. At no stage of this operation do the Chinese become decisively engaged. When the regiments have withdrawn to the regimental final interception line, mobile defense operations by the regiments in the division MDP cease and the mobile defense by the next higher echelon is initiated.

Forces:

- in the division MDP — normally two reinforced regiments,
- in the regimental MDP — normally one reinforced battalion,
- in the battalion MDP — normally one reinforced company,
- in the company MDP — normally one reinforced platoon, and
- in the platoon MDP — normally one reinforced squad.

Tasks:

- to inflict maximum casualties on the enemy,
- to cause the enemy to deploy across the FEBA and attack the defended positions, and
- to effect withdrawal before becoming decisively engaged while delaying the enemy's advance.

(3) The Position in Depth (PD)

The division PD is a designated defensive zone occupied by the division's second echelon, normally consisting of the division's third regiment, the remainder of the division's organic strength, and possibly reinforcements from the army. The second echelon of regiments and smaller units occupying their respective PDs, on the other hand, is composed of two-thirds of the unit's strength. The purpose of these forces, depending on the situation, is either to carry out a positional-type defense along final interception lines or to mount counterattacks against overextended, hostile forces.

Forces:

- in the division PD — one infantry regiment and one tank regiment minus,
- in the regimental PD — one battalion,
- in the battalion PD — one company,
- in the company PD — one platoon, and
- in the platoon PD — one squad.
- in the platoon PD — two infantry squads.

Tasks:

- to mount counterattacks aimed at the destruction of enemy forces,
- to conduct a position-type defense along previously designated defensive (final interception) lines,
- to assist in the withdrawal of the first echelon forces from the MDP,
- to provide a mobile reserve, and
- to provide flank and rear area security.

(4) Fire Support

The principles of fire support and the allocation of artillery were described earlier in this chapter.

- **Fire Plan.** In positional defense, the fire plan is centralized at army and division levels. In mobile defense, however, the planning and employment of artillery are delegated to subordinate commanders in order that fire may be responsive to the rapidly changing tactical situation.
- **Antitank Plan.** The majority of antitank weapons are allocated to frontline units to counter potential tank threats. These units are then responsible for planning their own antitank defense within the overall defensive plan.
- **Air Defense Plan.** Divisions and regiments plan for the deployment of their organic defense units. Priority for protection is given to unit headquarters, artillery positions, and mobile reserves.
- **Deployment of Artillery.** Organic and attached artillery are organized into the following groups:

Long-range Groups. Normally deployed some 5 to 10 kilometers behind the FEBA, providing direct support to battalions and regiments.

Direct-support Groups. Normally deployed some 2 to 5 kilometers behind the FEBA, providing direct support to battalions and regiments.

Roving Groups. Normally deployed in the division security position or the MDP as part of a combined-arms team.

b. Conduct of the Battle

(1) In the Division Security Position

Following the withdrawal of the army covering

force, the two reinforced battalions, which constitute the division security force and are under the operational control of the division commander, make contact with the enemy some 5 to 10 kilometers forward of the FEBA. This force engages the enemy and delays him for as long as possible until he is forced to withdraw through the FEBA. The battalions then revert to the operational control of their respective regiments where they become part of the regiment's second echelon deployed in the PD.

(2) In the Main Defensive Position and the Position in Depth

Elements of the regiment's first echelon occupying defensive positions along the FEBA engage the enemy in an attempt to stop his advance and force him to deploy his forces for a coordinated attack. As the coordinated attack develops, the regiment commander, depending on the situation, has three courses of action:

- to order the first echelon forces to continue defending along the FEBA, without becoming decisively engaged,
- to mount a counterattack employing the second echelon forces, or
- to order the first echelon forces to withdraw to defensive positions along the regimental final interception line while carrying out aggressive delaying actions, assisted by mobile elements of the regiment's reserve, if enemy pressure increases to such an extent that it is considered inexpedient to continue the defense along the FEBA.

If a withdrawal is undertaken, as soon as the first echelon is deployed along the regimental final interception line, the conduct of the mobile defense is assumed by the division commander. As the enemy attack continues, the division commander is afforded the same three options as his regimental commanders: to defend, to counterattack, or to withdraw to defensive positions along the division final interception line while delaying the enemy's advance. If the division withdraws behind the division final interception line, the army commander then assumes control of the mobile defense. This "stepping back" process continues until the aim of the mobile defense is achieved.

SECTION J — RETROGRADE OPERATIONS

Contemporary Chinese doctrine regarding retrograde operations is unclear although it is believed to parallel certain US definitions.

SECTION K — SPECIALIZED OPERATIONS

I. RIVER CROSSINGS

a. Background

Most crossings are made by fording and swimming, using hastily constructed rafts or bridges, or by commandeering boats from the local populace. The acquisition of modern river-crossing equipment from the Soviet Union in the 1950s and 1960s and the Chinese manufacture of Soviet-designed equipment have improved the CPLA's capability to conduct river-crossing operations.

Chinese doctrine considers the river crossing to be merely a phase of the normal advance to be conducted without any loss of momentum. Whenever possible, crossings are made at night or under conditions of poor visibility. If it is necessary to make a crossing by daylight, smoke is used to conceal both the preparations and the operation.

Frontages and objectives are similar to those for a normal attack (described earlier in this chapter).

Principles. The following principles are regarded by the Chinese as a key to a successful river crossing:

- reconnaissance,
- early planning and thorough organization,
- destruction of the enemy in the area,
- deception,
- improvisation of crossing aids,
- speed and surprise,
- crossing on a broad front,
- swift development of the attack on the far bank,
- massing of forces against enemy weak points, and
- air defense.

Types of River Crossings. The Chinese execute two types of river crossings: the hasty crossing and the deliberate crossing.

- *The hasty crossing* is a swift, uninterrupted movement normally conducted from the line of march.
- *The deliberate crossing* is undertaken only if a hasty crossing has failed or if a large, well-defended water obstacle has to be crossed and breached.

b. Nonengineer Water-Crossing Capability

Infantry. The standard Chinese infantry division possesses limited organic equipment for river crossings. It is thoroughly trained, however, in improvising field expedients for crossing minor water obstacles. Ponchos make temporary floats for ferrying machineguns, recoilless rifles, and mortars. Rafts made from oil drums and bamboo are used to carry heavier weapons and supplies. The bulk of the forces swim or wade even major rivers. Ropelines from bank to bank speed up the crossing and provide safety.

Tanks. The CPLA T-34/85, Type 59, and Type 62 tanks can wade up to a depth of 1.2 meters. The Chinese are not known to possess snorkel equipment. Type 62 and Type 63 tanks, found in the reconnaissance elements of both infantry and armored divisions, are the only amphibious tanks in the Chinese inventory. They are the CPLA's primary armored reconnaissance vehicles. (See appendix U which provides information and illustrations on all types of ground forces equipment.)

APCs. The Type 63 APC, found in the mechanized infantry regiment of the tank division, is amphibious.

Artillery. Chinese guns and prime movers are not amphibious and rely on engineer crossing facilities.

c. Engineer Water-Crossing Equipment

The CPLA is believed to have increased the quantity of engineer water-crossing equipment in its inventory. Most is of Soviet design, with some dating back to World War II. In spite of the progress made, however, China's ground forces rely heavily on improvisation and local resources to support any major river-crossing operation.

Amphibians. The CPLA is thought to possess a few old Soviet-built tracked amphibians at army level. In addition, US manufactured DUKW-type wheeled amphibious trucks and LVT-type tracked amphibious carriers were captured from the Nationalists. There are reports of recent Chinese experimentation with air-cushion vehicles, but it is not known if any are in production or assigned to operational CPLA units.

Bridging.

- *Tank Bridge Layer.* It is thought that the Chinese have some T-54 MTU Soviet-class 50 bridge layers which span 11 meters.

- *Vehicle Launched Bridge.* The Soviet truck-mounted scissors bridge (KMM) is known to be in the inventory. In addition, it is thought that the Chinese may have some TMMs, load class 60.

- *Bridges:*

- (1) light bridge with plywood pontoons and wooden superstructure similar to the obsolete Soviet DLP,

- (2) medium bridge with steel pontoons and superstructure similar to the Soviet N2P-45,

- (3) heavy bridge with steel pontoons and superstructure (Soviet TPP/TMP) imported from the USSR,

- (4) improvised bridges built below water level at a safe vehicle traversing depth,

- (5) TZI footbridge (Soviet), and

- (6) unknown quantities of Bailey bridging.

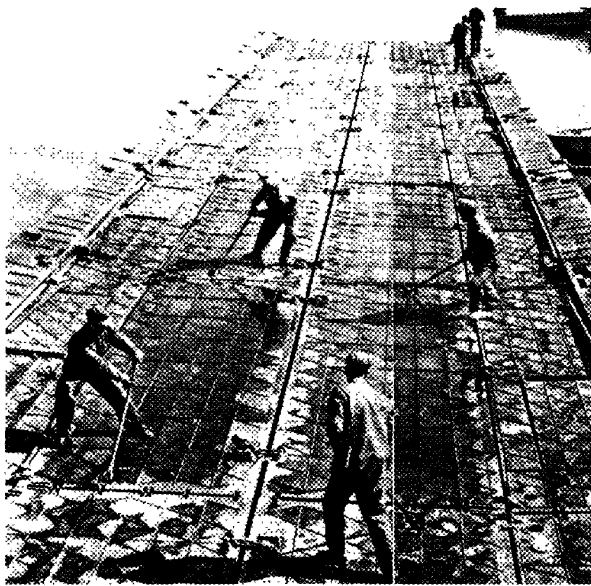

Setting Up a Pontoon Bridge.

Rafts and Ferries. Varying numbers of rafts can be constructed from the bridging mentioned above. If rafts are to be built, the length of the bridges must be reduced in proportion to the number of rafts used.

Boats:

- simple, collapsible assault boats capable of carrying 10 men or about 2 metric tons,
- steel pontoon boats, 25-man or 5-metric-ton capacity, normally used as the basis for pontoon bridges,
- inflatable five-man reconnaissance boats, and
- large numbers of civilian wooden boats ranging from one-man fishing boats to large junks.

d. Conduct of the Operation (in the hasty crossing)

A possible sequence of actions by an infantry division crossing a water obstacle from the line of march is described below.

Preliminaries. The division commander makes an outline plan for the crossing and issues orders in the rear assembly area. Division and regiment reconnaissance platoons, reinforced with elements of the division's engineer battalion, are dispatched ahead of the main body to reconnoiter crossing sites, forward assembly areas, and the near bank. They also reconnoiter the far bank to determine terrain conditions and enemy strengths and dispositions. Concurrently, river-crossing equipment, both organic and improvised, is assembled in selected areas near assault positions and crossing sites.

Approach. The division adopts a formation normal for a movement to contact in its approach to the water obstacle. After the reconnaissance is completed, an advance guard or forward detachment from each first echelon regiment, normally of reinforced battalion strength, is assigned the mission of securing the near bank and, when possible, of forcing the initial crossing. If the crossing cannot be accomplished in this manner, the advance guard is employed to secure the near bank on a broad front, destroy obstacles, and establish a base of fire to support crossings by the assault elements of the regimental first echelons.

The Assault. The assault regiments are located in covered assembly areas some 3 to 5 kilometers from the obstacles. The first echelon battalions move from these assembly areas, cross a line of departure as near to the obstacle as possible, and begin crossing under the cover of direct and indirect fires. The assaulting battalions initially move in column to facilitate control, but on nearing the obstacle deploy and make the crossing on a broad front. The supporting battalions normally cross in successive waves at the closest interval possible. Every effort is made to get some artillery across the river with the assaulting battalions and regiments. Usually the artillery plan employs two-thirds of the artillery engaging the enemy while one-third is crossing the river.

Operations on the Far Bank. On reaching the far shore, the assaulting troops move inland as quickly as possible to clear the crossing area of direct enemy fire and secure the flanks. Each assault battalion is expected to establish a beachhead from 1 to 2 kilometers wide and approximately 1 kilometer deep, but these dimensions will vary with the terrain. The landing area is cleared of mines and obstacles so that bridges may be constructed and ferries used to facilitate the crossing of tanks, supporting weapons, and second echelon forces.

e. The Deliberate Crossing

The deliberate crossing differs from the hasty crossing largely in the degree of preparation. A thorough reconnaissance is conducted in advance and a detailed fire plan is organized. Preliminary preparations are carried out in assembly areas well to the rear of the obstacle. Movement toward the obstacle is usually made at night, under the cover of preliminary bombardment fires and the actions of forces in contact on the obstacle. The actual assault and crossing usually take place at dusk or during other periods of poor visibility, under cover of artillery fires. The crossing and consolidation generally

then follow the lines of the hasty crossing although timings inevitably are slower by night.

2. AIRBORNE OPERATIONS

a. Background

China's airborne forces are thought to consist of three divisions located in Wuhan Military Region and are part of the CPLA's strategic reserve. Airborne forces are an integral part of the Air Force, not of the ground forces.

Chinese doctrine envisages the use of airborne troops, although the limited numbers and types of transport aircraft and helicopters available are limiting factors. Airborne operations include:

- *Parachute Operations.* Carried out by paratroopers and followed, if required, by air-landed troops trained and equipped for air transportable operations.

- *Air Transportable Operations.* Limited operations to quickly reinforce border areas or to maintain internal security within China. In addition, these specially trained air transportable troops could be used in operations in countries peripheral to China.

- *Helicopter-Borne Operations.* Currently, because of a shortage of helicopters, only extremely limited operations can be carried out. This capability is expected to improve, however, as more helicopters become available.

b. Parachute Operations

Roles. The Chinese are expected to use their airborne forces in the following roles:

- seizure of important areas, routes, and crossings in advance of major thrusts or to protect the rearward movement of Chinese forces,
- sabotage missions against nuclear delivery means, support units, and guidance equipment,
- disruption of troop control, movement and logistic support by operations against headquarters, communications centers, and rear areas installations,
- support of amphibious landings,
- assistance to guerrillas, and
- internal security missions.

Size of Force. The Chinese possess the capability to conduct airborne operations of at least regimental size against objectives within a 900-kilometer radius.

Organization of an airborne division is shown in appendix F.

Equipment. The division inventory is similar to that of a normal infantry division except that it has no tanks and only limited artillery, antitank, and antiaircraft weapons.

b. Types of Operations

Parachute operations are divided into the following categories:

Strategic. Operations involving the use of only one or possibly two airborne divisions in special circumstances such as:

- seizure of airbases, seaports or islands of strategic importance,
- support of deep penetrations following a breakthrough of the enemy defenses, and
- holding vital terrain in the case of a major invasion of China.

Tactical. Operations of regiment or battalion size on the main axis in support of an army group or army offensive, timed to allow ground forces to link up with the airborne troops within 1 to 3 days.

Special Purpose. Operations by parties of up to battalion strength in any area with the tasks of sabotage, disruption of control and logistics operations, and in support of guerrillas.

c. Conduct of Operations

Little is known about the manner in which the Chinese carry out their airborne operations, but it is assumed that for the most part they follow Soviet methods.

A division uses about four to six drop zones (DZs) and a regiment uses one or two. Reserve DZs are normally selected for use in an emergency or by subsequent waves. DZs are about 3 to 4 kilometers in size and, if circumstances permit, may be on or outside the objective itself.

Landing. The fly-in is protected by fighter cover. All available fire support is used to neutralize enemy air defense weapons along the flight path. Drops are normally made at night.

3. WARFARE UNDER SPECIAL CONDITIONS

a. Amphibious Operations

China conducted its first joint amphibious operation in January 1955 against Yijiangshan Island, about 25 kilometers off the coast of Zhejiang Province. Since that time amphibious training has had an important place in the training of units stationed near the coast. China's successful occupation of the Xisha (Paracel) Islands, which were held by South Vietnamese forces in January 1974, is the most recent example of the CPLA's ability to conduct amphibious operations.

At present, China possesses the capability to conduct an amphibious operation involving three infantry divisions, their organic armor, artillery, and those personnel and equipment that would be required during the assault phase of an amphibious operation. In addition to naval amphibious ships

and craft, merchant shipping and motorized junks would be used to support the effort.

Amphibious Units. The CPLA is believed to have a number of units which have been trained in amphibious operations. During an amphibious assault, these forces, organized into regiments, would spearhead the landing, conducting beach reconnaissance, clearing obstacles, and making the initial assault. It is not known if the Chinese have marines or naval infantry specifically designated for amphibious warfare.

Types of Operations. Amphibious operations would necessarily take place within range of shore-based aircraft and would aim to:

- seize and secure a beachhead on a hostile shore from which large-scale ground operations can be initiated,
- assist the advance of ground forces by attacking the sea flanks of an opposing force,
- seize and secure vital areas such as islands and straits, and
- conduct raids and reconnaissance.

Scale. A division conducting an amphibious operation is divided into two echelons: an assault echelon, consisting of two reinforced regiments, and a support echelon, consisting of the remainder of the division's forces.

The Assault Landing.

- **Airborne.** An amphibious landing may be preceded by, or made simultaneously with, a parachute- or helicopter-borne assault onto or near the beachheads.
- **Night.** The approach is normally made at night or under other conditions of poor visibility. Amphibious landings are normally made at night or at first light.
- **Frontages.** Frontages are similar to those for the attack described in section H of this chapter. Each battalion is allocated one landing point and these are at least 1 kilometer apart.
- **Control.** Chinese doctrine prescribes a unified command for amphibious operations. The commander of such an operation is usually a senior army commander who is responsible for the execution of the operation. In addition, two subordinate commanders are designated and charged with specific responsibilities during each phase of the operation.

(1) **Naval Landing Commander.** He is a senior naval officer responsible for embarkation, movement by sea, and landing ground troops on the hostile shore. During this period of the operation he is in command.

(2) **Landing Force Commander.** As soon as adequate communication and command facilities have been established ashore, command

passes from the naval landing commander to the landing force commander. He is charged with direct command of ground force troops during the preembarkation period, coordination of ground force troops during the assault, and command of tactical operations ashore to seize and secure the beachhead.

• **Tactics and Fire Support.** The tactics and fire support of an amphibious landing are similar to those employed by both Soviet and Western armies. Coordinated air and naval gunfire provides continuous fire support aimed at neutralizing or destroying enemy defenses. Artillery on nearby land masses may also be integrated into the overall fire plan.

b. Cold Weather Warfare

Due to perceived threats along China's northern frontier, special attention is given to winter warfare training in the CPLA. The Chinese believe that large-scale ground operations are possible in extreme climatic conditions.



Cold Weather Training.

Influence of Climatic Conditions. Twenty to 30 centimeters of accumulated snow will retard the mobility of infantry, armor, and artillery; over 30 centimeters of snow will cause extreme difficulties in their movement. Heavy snowfalls require intensive troop labor to clear essential roads and maintain fortifications; snow makes troop movement concealment difficult. Extreme cold has a direct effect on troop stamina and on their equipment. Subzero temperatures radically alter the tactical significance of certain terrain features like rivers, lakes, and swamps.

Tactical Concepts. Chinese tactical operations in winter do not differ greatly from those conducted under less severe conditions. Cold weather conditions increase the importance of shelters, hinder the

construction of defenses, make rivers, lakes, and swamps passable, and restrict air support.

Chinese doctrine emphasizes the need for more continuous reconnaissance to locate the enemy's main strength and flanks, the direction of his movement, and the disposition of his nuclear weapons. In addition, particular attention is paid to weather reconnaissance, the depth of snow on the avenues of approach and the thickness of ice on water obstacles. The reconnaissance is conducted by small units on skis or in vehicles capable of cross-country movement.

Organization. No special organizations are known to exist for cold-weather warfare although some specialized equipment undoubtedly is issued to units.

The Offensive. In cold-weather warfare, assembly areas are located closer to the enemy than at other times to lessen approach marches and thereby minimize fatigue and the possibility of frostbite. Heated shelters are provided in assembly areas and covered shelters in attack and, if possible, in assault positions.

Defense. The FEBA is selected making the maximum use of natural climatic obstacles difficult to overcome in winter. All cover available to enemy in front of the FEBA is destroyed by demolition or covered with planned artillery fire. Holes are made in frozen lakes or rivers and the ice is mined. Obstacles, including minefields covered by fire, are constructed in gaps between a system of strongpoints. No more than a third of fighting personnel occupy firing positions at a time.

c. Fighting in Built-up Areas

Attack. When encountering a town that must be seized during the advance, the commander normally strives to capture it from the line of march before the enemy can establish elaborate defenses. The advance guard moves into the town, seizes important objectives, and holds them until the main body arrives. When an attack from the line of march fails, the commander establishes a blockage and initiates preparations for a deliberate attack on the town. The deliberate attack is preceded by an artillery bombardment supported by air strikes. The attack normally consists of several converging attacks initiated in different sectors of the town to split the enemy defenses into several segments for subsequent piecemeal destruction.

Defense. The defense of a town or city is organized for all-round defense based on inner and outer defense zones. Inner defense zones are established throughout the entire town; their number and size are dependent on the size of the town and the overall defense plan. Each zone is based on a

system of defense centers each of which consists of two or more strongpoints. The forward edge of the first inner defense zone is normally placed on the town's outskirts. Outer defense zones are established on the approaches to the town. Their number depends on the terrain and available manpower and materiel; frequently these positions are merely combat security positions.



Adapting to Local Conditions: Urban Fighting.

d. Mountain Warfare

Chinese combat forces are trained for operations in mountainous terrain. The difficulties imposed by terrain, however, often dictate the use of special equipment. At extremely high altitudes, as along the Sino-Indian border, acclimatization is necessary.

The Offensive. The usual type of offensive maneuver is a frontal attack of the enemy with regiment- and or battalion-size units operating on independent axes along roads, valleys, and ridges in conjunction with enveloping movements across adjacent mountains. Enveloping forces are employed to seize commanding heights, passes, and road intersections on the flanks and rear of the enemy position while the main force carries out the frontal attack. If the enveloping forces succeed in making the enemy withdraw before the main frontal attack is initiated, the main force immediately carries out a pursuit to prevent the enemy from occupying another defensive position.

Defense. The defense is organized as a series of strongpoints on the commanding heights, each mutually supporting and capable of all-round defense. Gaps are covered by patrols. In the event of strongpoints being surrounded, they continue to fight on without any thought of withdrawal. Constant observation and patrolling are carried out to prevent outflanking movements.

Fire Support. Fire support for Chinese forces in mountainous country does not differ greatly from the support afforded in offensive and defensive operations under normal terrain conditions.

The Use of Armor. Every effort is made to employ tanks in areas where the enemy will not expect them; in the defense, tanks are sometimes deployed in forward infantry strongpoints.

e. Jungle Warfare

Combat forces assigned to areas where jungle terrain predominates receive specialized training in the conduct of jungle operations. The organization, equipment, and tactics of these forces are often tailored to offset the adverse effects of the terrain and the monsoon climate.

Terrain. Mountainous jungle terrain prevails in southern China, primarily in Yunnan and Guangxi. These areas are characterized by rugged terrain, dense first- and second-growth jungle, small scattered villages and cultivated areas, numerous streams and marshes, few highways or rail lines, and networks of unimproved trails.

Organization and Equipment. Mountainous jungle terrain has a leveling effect on the relative capabilities of opposing forces since it limits sharply the employment of armor, heavy artillery, and vehicular transport, and restricts aerial observation. The standard Chinese infantry division would probably be stripped of its tank regiment and heavy artillery so as to resemble a light infantry division. Much of the fighting in the border war with Vietnam in 1979 was carried out in rugged, jungle covered mountains. Although heavy artillery and

tanks were used in the initial assault and the attacks on Cao Bang and Long San, most CPLA troops fought in small units with hand-held weapons. Both Chinese and Vietnamese troops attempted to surround and infiltrate each other; the picture that emerges from press reports is of a confused battle at close range between small units. CPLA infantry units were praised for their heroism in continuing to fight after going for several days without food or water, while artillery units were commended for succeeding in moving their guns along narrow trails and roads and supporting the infantry with direct fire at concealed positions. The CPLA suffered logistic difficulties as well as problems of coordination and communication between scattered units, and between infantry and artillery.

Tactics. The tactics employed by the CPLA in a jungle environment stress taking full advantage of natural cover; extensive use of infiltration, ambushes, and guerrilla warfare; secrecy and speed of movement; continuous reconnaissance; and well-coordinated planning. Maintaining control over his forces is the primary problem confronting a commander because of the restrictions on movement and communications imposed by the terrain.

SECTION L — LOGISTICS

1. OVERVIEW

a. Army Level

Within the combat zone, the army formation is the key unit of logistic operations and management. The commander of the army logistics command



Jungle Conditions

controls most service troops assigned or allocated to the army, except engineer and signal troops. He is responsible for the supply and service support of the divisions, army troops, and reinforcements allocated to the army; for planning and supervising all logistical operations in the army rear area; and for liaison with logistics departments of higher, adjacent, and lower commands.

b. Division Level

The division logistics department develops all logistical plans relative to division operations and informs the army logistics command of division requirements. Bulk supplies and replacements are received from army and are broken down according to subordinate commands' allocations.

c. System of Supply

The CPLA's system of supply has been discussed in general terms in chapter 1, section D. The ground forces logistics system follows the patterns as described (see figure 11). Resupply from army to division, from division to regiment, and from regiment to battalion is normally accomplished by a "push" distribution system.

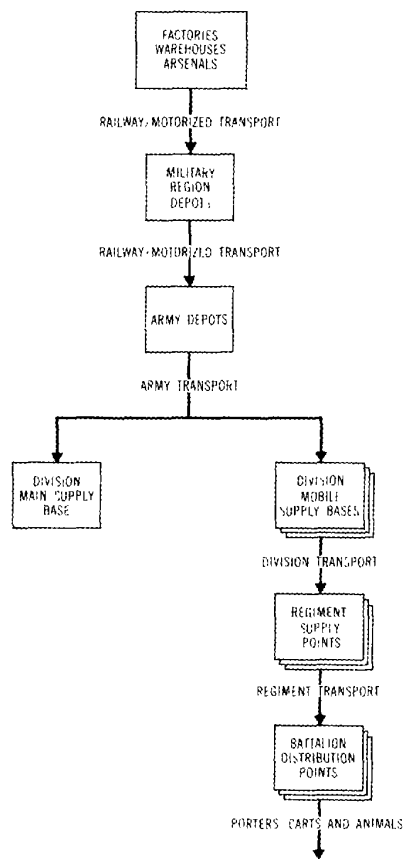

Figure 11. System of Supply.

Daily Resupply Requirements. The following table lists the average daily resupply requirements (in metric tons) of a standard CPLA infantry division at varying levels of combat:

Level of Combat	Ammunition	POL	Supplies	Rations	Total Requirement
Heavy Combat	450	10	20	20	500
Moderate Combat	250	10	20	20	300
Light Combat	100	10	20	20	150
Average Requirement (Protracted Period)	150	10	20	20	200

Higher level transportation assets than those listed in the table above would normally be used to deliver supplies to the division and thus different levels of combat would have little effect on POL consumption.

2. AMMUNITION

Army, division, and regimental logistics departments maintain ammunition supply dumps. Ammunition stocks to be maintained at each echelon are specified by higher headquarters. Resupply of ammunition from battalion forward may be accomplished by human, animal, or motor transport depending on the distances involved, the terrain, and the combat situation. During combat, resupply of ammunition is facilitated by the establishment of temporary ammunition dumps and frequent shifting of supply points. The stockpiling of ammunition in forward areas is a common procedure.

The CPLA uses the term "basic quantity" as the measure of ammunition supply. A basic quantity, similar to the Soviet "unit of fire," is the number of rounds to be maintained for each weapon within a unit. It is an arbitrary amount used for accounting and planning purposes, although it does have some relation to combat requirements. Ammunition is requisitioned by units or allocated for an operation in multiples of the basic quantity. Under normal conditions one basic quantity is maintained for all weapons with the units of the division; another one-half to one is held in reserve by the division logistics department. In addition, a reserve of one or more basic quantities is held at army level. Typical basic quantities for selected weapons are indicated as follows:

- Type 59 medium tank — 34 rounds,
- 122-mm howitzer, Type 54 — 80 rounds,
- 82-mm mortar, Type 53 — 120 rounds, and
- 7.62-mm carbine, Type 56 — 100 rounds.

3. POL

The Chinese probably follow the Soviet practice of measuring fuel in "refills." One refill is the quantity required to fill the internal and external tanks of all vehicles in a unit, plus lubricants allocated at 10 percent of the fuel required. Normally, the division carries from two-and-a-half to three refills: one in

the fuel tanks of the vehicles, one-half each at battalion level and regimental level, and one-half or one at division level.



Refueling.

Delivery. Reserve POL stocks are dispersed in remote areas. These reserve sites are often well hardened against air attack and are, wherever possible, serviced by rail. Military region depots maintain peacetime stocks equivalent to wartime front or theater area stocks. Army, division, and regiment logistics departments maintain POL dumps. Most fuel and lubricants are transported and stored in 55-gallon drums and 5-gallon cans. Division vehicles haul POL forward from division POL dumps to regimental dumps. Regimental vehicles, in turn, transport POL forward to battalion supply dumps, as required. Within those battalions having organic transport, POL is distributed at the battalion POL point.

Captured Stocks. The Chinese will supplement normal POL with captured stocks. It is unlikely, however, that they would rely on captured stocks in their logistic planning.

4. RATIONS AND WATER

Rations. The CPLA issues three kinds of rations: the standard ration, the combat ration, and the emergency ration.

- The *standard ration* consists of rice, flour, pork, fish, eggs, soybeans, vegetables, edible oil, and salt, sugar, and other condiments. The individual soldier is issued 4 to 6 kilograms of food per day. Most of the fish, pork, and vegetables are produced locally by individual units for their consumption.
- The *combat ration* consists of dried rice, dried fried wheat, or a baked mixture of soybeans, corn, millet and kaoliang (Chinese sorghum) to which water is added before eating. Prior to a major operation, each soldier is issued the equivalent of from 5 to 7 days' rations.

- The *emergency ration* is a compressed, rectangular biscuit made of flour, salt, and oil. Each soldier carries about 12 of these biscuits in addition to his combat ration.

Under simulated or actual combat conditions, companies, battalions, and regiments each store the equivalent of 7 days' supply of rations. Divisions maintain 10 days' supply, and armies from 2 to 4 weeks' supply. Rations are delivered from division to regiment, and from regiment to battalion and company, or directly to forward positions. During troop movements in peacetime, rations are often purchased from local communes.

Water. The Chinese possess the equipment to supply fresh water in the field as well as the capability to test and treat contaminated local water supplies. Water supply is the responsibility of the engineer section of a given unit; water purification is the responsibility of the medical section.

5. MEDICAL

Medical departments of logistics units supervise medical evacuation and designate routes and evacuation centers. Litter bearers are normally used at battalion level and below. Ambulances and/or litter bearers are used at the regiment and division levels, although supply vehicles may also be employed.

Battalion. Soldiers wounded in combat are attended by rifle company first aid men at company collection centers where first aid is administered and field dressings are applied. Evacuation of casualties from the company collection center to the battalion aid station is usually by litter bearers. At the battalion aid station, wounds are rebandaged, bones are set, injections are given, and the more seriously injured are prepared for evacuation to regimental field dressing stations. Battalion aid stations are usually located about 1,000 to 2,000 meters from the frontline.

Regiment. Regimental ambulances or litter bearers collect casualties from battalion collection centers (collocated in the battalion aid station) and transport them to regimental field dressing stations located 4 to 8 kilometers from the frontline. Emergency surgery may be performed at this level if the patient's condition makes further movement inadvisable. Otherwise, treatment at this level is limited to classifying wounds, stabilizing patients and, if required, preparing patients for evacuation to field hospitals.

Division. Ambulances from the division medical battalion pick up wounded at the field dressing station's collection center and evacuate them to mobile hospitals at division level and to army field hospitals. The mobile hospitals provide limited medical

care, including minor surgery. The field hospitals perform major surgery and treat patients not requiring long periods of hospitalization. Serious cases requiring special care, special surgery and/or long periods of convalescence are evacuated to regional or base military hospitals found at provincial or military district level. Personnel who have recovered from wounds or injuries may be returned to duty by any medical facility in the chain of evacuation.

6. RECOVERY AND REPAIR

General. The CPLA's current system of recovery and repair is believed to be based largely on the Soviet system. Simple repair is encouraged at the unit level and fabrication and cannibalization are practiced. Mobile field repair teams are found at many units of regiment level and above. The shortage of technicians, the scarcity of spare parts, and the limited number of repair facilities were often cited in the past as indications of the CPLA's weakness in the area of recovery and repair. These deficiencies were believed to have been overcome, but reporting on the Sino-Vietnamese conflict indicates that the problems still remain under combat conditions.

Maintenance. Preventive maintenance is continually stressed at all levels in an attempt to decrease the number of equipment breakdowns and to lighten repair workloads. Upgrading the technical proficiency of mechanics and operators through both special and on-the-job training is also encouraged.

Recovery. Battlefield recovery of both friendly and enemy material is considered of prime importance. Every unit is responsible for the collection and evacuation of all usable weapons or equipment within its area. When the collecting unit cannot handle the evacuation, specially designated recovery teams from higher headquarters will move the material to the rear where it is processed. At army and division, each service maintains a collection point for salvage material at rear area supply installations. Below division, a single collection point is established for salvage of all classes of material.

Repair. The Chinese have three categories of repair: minor repair, medium repair, and major repair.

- *Minor repair* includes periodic checks, replacement of subassemblies, and fabrication of spare parts. It is normally accomplished at regiment level.
- *Medium repair* includes cannibalization, salvage, and patching as well as minor repair. Medium repair is usually performed at division and army levels.
- *Major repairs* are normally carried out at military region level in large fixed-shops or salvage-and-rebuild installations. Here complete equipment

rebuild is accomplished. Material judged not salvageable is cannibalized for parts.

Echelons of repair are determined by the capabilities of the facilities at any particular level. Repairs are made at the lowest possible echelon to reduce the time lost in evacuation. In addition, because of a lack of recovery equipment, repair is attempted at the point of disablement, although such repair is often hampered by the lack of mobile repair teams. Logistics departments at both regiment and division headquarters have ordnance repair sections responsible for the maintenance and repair of all items the CPLA considers ordnance. Signal maintenance and repair are performed by the signal battalion at division level and by the signal company at regiment level.

SECTION M — TRAINING AND SCHOOLS

1. BASIC TRAINING

Each infantry division trains its own recruits. Basic training takes about 2 months, with recruits entering in an annual draft soon after Chinese New Year. The army trains in a 10-month cycle, beginning in the spring with individual training, and progressing from small unit to division and army level exercises in late autumn and winter.

2. ONGOING TRAINING

Shifts in training policy since 1978 are summed up by the Chinese as the "three changes" — change the main target of attack from the enemy's infantry to his tanks; change from training each service arm separately to the coordinated training of a combined force; and change the primary emphasis from the training of fighters to that of cadres. The new policies have been adopted to improve the ability of the CPLA to fight a modern war and to meet the perceived threat. Special attention is given to studies of foreign armed forces, and particularly to Soviet doctrine and tactics. One third of all training is done at night. Night operations using and countering night vision and illumination equipment receive special emphasis.

In 1979, a Shenyang Military Region division was praised for having halved the time devoted to training in bayonet fighting and grenade throwing. The time was allocated to further training in antitank, antichemical, and antiair defense. Training in the use of antitank rocket launchers was increased from 144 to 190 hours.

3. SCHOOLS AND INSTITUTES

The military regions operate a system of schools and training institutes. Fighters selected for promotion to cadre status are sent to these schools for

courses lasting up to 2 years, after which they normally return to their original unit. The CPLA also operates a system of military technical institutes which graduate specialists in such fields as electrical engineering, foreign languages, ordnance, and medicine.

The CPLA Military Academy in Beijing is the highest level training institute. It enrolls cadres from the entire CPLA, offering a basic course lasting 18 to 24 months for about 500 division deputy commanders and chiefs of staff and regimental commanders, and a 12-month senior course for

about 100 cadres of division commander and higher position. Political reliability is a prerequisite and most of the training is military. Familiarization with other branches of the CPLA and with combined operations is a major goal of the training. In the CPLA, as in China generally, individuals normally spend their entire careers in the same unit, rather than rotating from unit to unit on short tours. A division commander might well have spent 30 years in the same division. Attendance at the Military Academy is one of the few opportunities to broaden the horizons of such senior cadres, and to prepare them to train their subordinates in modern warfare.

CHAPTER 3

NAVAL FORCES

SECTION A — ORGANIZATION

1. NAVY HEADQUARTERS

The top command of the CPLA Navy consists of a commander and a political commissar who are assisted by deputies and a headquarters staff to supervise the operational, political, support, technical training, and other functions of the Navy. In line with Chinese military practice, the commander and political commissar share responsibility.

Joint action of naval units with other elements of the armed forces, such as aircraft, coastal defense or antiaircraft artillery units, is coordinated through Navy Headquarters.

2. FLEET COMMANDS

The Navy is organized into three fleet commands: North Sea, East Sea, and South Sea. The headquarters of these fleets exercise operational control in their respective areas over all afloat forces, naval air units, and the ashore elements of coastal defense. The fleet commands are also believed to have administrative control over base, shipyard, repair, and training facilities located in their respective areas, although naval headquarters has some direct control over most of these installations (see figure 12).

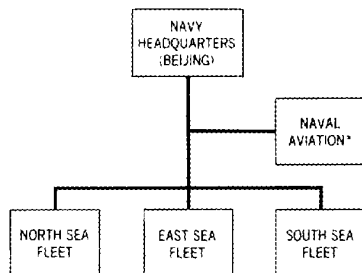

* NAVY FIGHTER DIVISIONS ARE PROBABLY CONTROLLED BY THE CPLA AIR FORCE FOR AIR DEFENSE OPERATIONS. OTHER NAVAL AVIATION OPERATIONS ARE PROBABLY ROUTINELY COMMANDED BY THE RESPONSIBLE FLEET HEADQUARTERS. MILITARY REGION HEADQUARTERS WOULD PROBABLY ASSUME OPERATIONAL COMMAND OF TACTICAL AIR UNITS IN WARTIME.

Figure 12. CPLA Navy Organization.

- The North Sea Fleet, headquartered at Qingdao, Shandong, protects Beijing and the strategically critical northeast plains from attacks through the Yellow Sea and Bo Hai Gulf.
- The East Sea Fleet, headquartered near Shanghai, defends the industrial Shanghai area and the shore of the Taiwan Strait.

- The South Sea Fleet, headquartered at Zhanjiang, Guangdong, guards commercial Guangzhou and China's insular flank in the South.

SECTION B — COMMAND AND CONTROL

As a major branch of the CPLA, the 360,000-man Navy is controlled through the naval headquarters which is directly subordinate to the Central Military Commission through the General Departments.

The commander of the CPLA Navy, assisted by his deputies and staff at naval headquarters, is responsible for a variety of forces, facilities, and organizations. Some are directly subordinate to naval headquarters, while others are controlled through subsidiary headquarters. Many naval elements appear to be under dual subordination, and in some instances interservice coordination must be effected as well.

SECTION C — SHIPS

1. NAVAL SHIPS

The Navy inventory includes a variety of ships of foreign (Soviet, Japanese, British, and United States) origin, as well as an increasing number and assortment of ships from Chinese yards. Many of those supplied by the Soviet Union and almost all of those taken over from the Chinese Nationalists are World War II warships. Domestic production resulting from an ambitious shipbuilding program begun in the 1950s includes submarines, missile boats, gunboats, torpedo boats, patrol boats, destroyers, frigates, and auxiliary craft.

2. ORDER OF BATTLE

The Chinese naval order of battle includes almost 2,300 ships and craft and continues to grow. The submarine force consists of one GOLF Class ballistic missile submarine and 100-odd conventionally powered torpedo attack submarines, the majority of which are WHISKEY and ROMEO Class units. In addition, the Navy has two HAN Class, nuclear-powered submarines of indigenous design, and one XIA class SSBN. Principal surface combatants include:

- 14 guided-missile destroyers,
- 14 guided-missile frigates (two of which are intended to be equipped with prototype surface-to-air missiles), and
- 5 frigates.

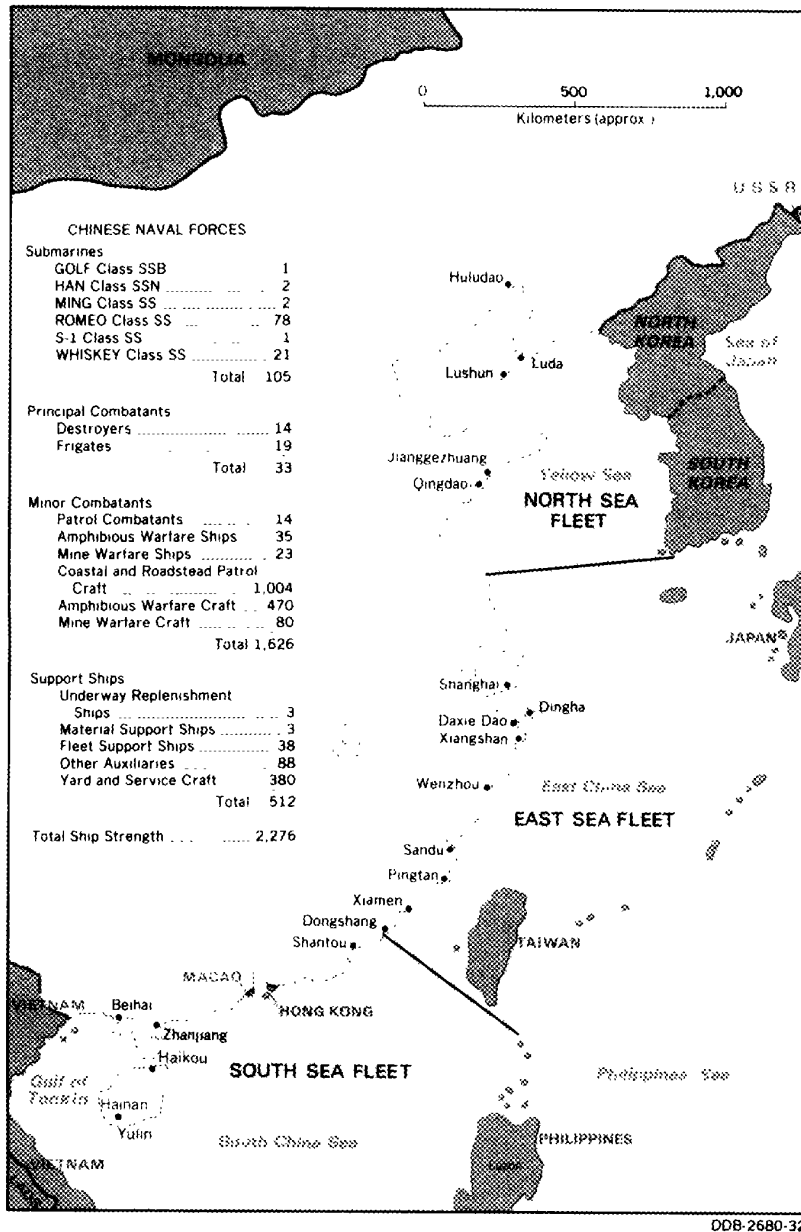

Figure 13. Naval Order of Battle and Major Bases.

A large number of minor combatants, auxiliary ships, and yard and service craft round out the naval inventory.

Chinese naval order of battle data can be found in figure 13. Chinese ships and craft are depicted in appendix V.

SECTION D — DOCTRINE AND TACTICS

I. GENERAL

The primary mission of the Navy — defense of the Chinese coast — is accomplished by constructing ships and craft well suited to their assigned

tasks, and by deploying these units in accordance with strategic priorities. The Navy reportedly also administers a vigorous and expanding training program. In recent years the Chinese have discussed open ocean operations by surface ships and submarines as part of the modernization of the Navy. China's construction of underway replenishment ships and effective use of the techniques of resupply at sea now permit the Navy to venture farther from the coast. This new capability was demonstrated in May 1980, when a task force of 18 ships sailed to the South Pacific to participate in the recovery of a new generation Chinese ICBM.

2. DEFENSIVE RINGS

China's Navy is the seaward extension of the CPLA. As such, it supports an integrated national defense plan. The outer ring of defense is believed to be a fleet of diesel-powered attack submarines which would defend against an approaching force with torpedoes and mines. Principal surface combatants provide a second defensive ring. Their sea-keeping ability, range, and speed provide flexibility and mobility to the defensive plan, enabling naval headquarters to quickly fill gaps through intra/interfleet transfers. This perimeter, however, is limited in depth to the protective range of bomb-and-torpedo-armed attack aircraft of the Naval Air Force. Defense of the inner ring, also under the protective air umbrella, is the task of the large number of fast missile boats, torpedo boats and gunboats, as well as patrol and mine craft. CPLA Navy tactical doctrine allegedly emphasizes the use of surprise attacks, combat at night and during periods of poor visibility, close combat with infiltration of an enemy's rear, and destruction of an enemy with a concentration of force. In addition, it is probable that extensive protective minefields would be laid to protect coastal shipping and to guard against amphibious assaults.

SECTION E — CAPABILITIES

1. SUBMARINE AND ANTISUBMARINE WARFARE

The Chinese fleet of 100-odd conventional attack submarines poses a substantial threat to any potential invader. Most submarines have operated in the relatively shallow waters of China's broad continental shelf. The Chinese claim to be capable of embarking on lengthy submerged voyages into the open sea, and their ROMEO Class submarine can travel over 5,000 kilometers and remain at sea for 30 days. Chinese submarines cannot stay submerged

for long periods of time and are noisy by contemporary standards when snorkeling or running on the surface. They are therefore vulnerable to modern antisubmarine weapons (ASW). Finding and destroying them, however, would require the commitment of an extensive antisubmarine force.

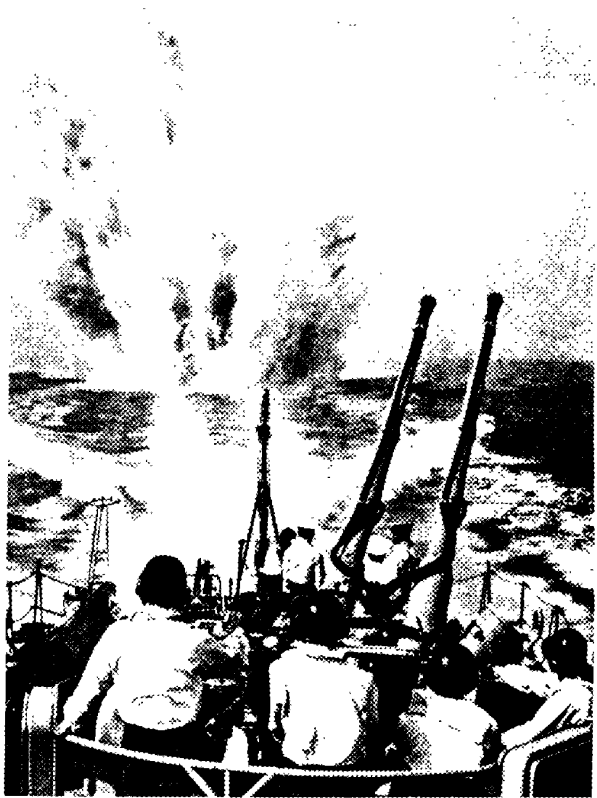

Antisubmarine Warfare.

If faced with invasion or a hostile fleet near its shores, China could deploy most of its submarines close to shore. The threat of a large number (20 to 25) of Chinese submarines operating at long-range would force an enemy to disperse its antisubmarine forces and further complicate an invasion or naval attack on China.

China's two HAN Class SSN nuclear attack submarines provide experience with nuclear propulsion systems, and they also could be employed to threaten an enemy fleet or lines of communication and thus increase the resources necessary for an attack on China. The Navy's one GOLF Class diesel-powered ballistic missile submarine probably was used to test-fire China's first submarine-launched ballistic missile (SLBM) — an intermediate-range

device — in 1982. China is also reported to have at least one XIA Class SSBN. Further discussion of SLBM systems and launch platforms can be found in chapter 5, section D.1.

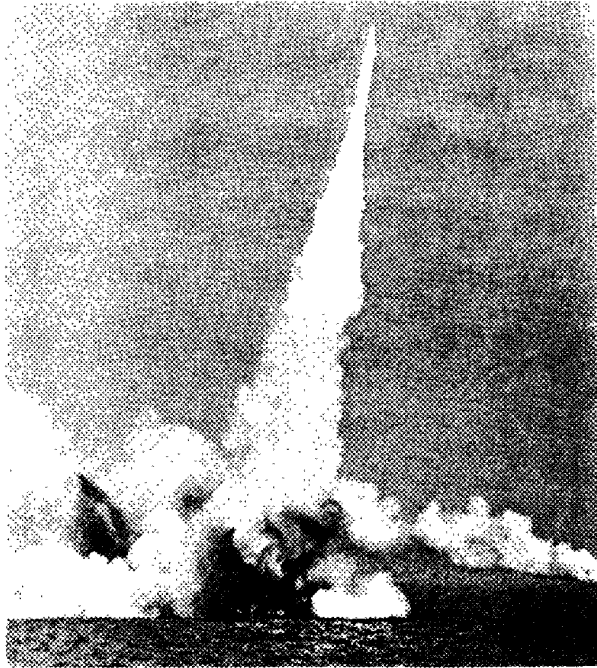

Submarine Launched Ballistic Missile Test Firing

Antisubmarine warfare probably is of high priority to naval planners, but since the Navy's sensors and antisubmarine weapons represent Chinese versions of early 1950s Soviet technology, Chinese ASW capabilities are modest. Should China decide to purchase foreign technology, antisubmarine capabilities could be improved in several years.

2. SURFACE WARFARE

China's surface warfare fleet is composed of a small number of destroyers and frigates and a large number of small missile boats. Coastal defense remains its primary mission, but the development of offshore oil operations will add to the Navy's responsibilities. Three new underway replenishment ships carry fuel oil, water, and solid stores, and permit destroyer and frigate forces to operate on the open sea for extended periods. This small number limits the Navy's ability to conduct combat operations for any lengthy period.

The Navy's primary weapon is the CSS N-1 cruise missile, a Chinese version of the Soviet STYX missile. It has a range of 45 kilometers and a radar/infrared homing seeker. It is carried on scores of

small missile boats and on most principal surface combatants. The CSS N-2, a longer version developed by the Chinese, carries more fuel and has a range of 75 kilometers. Because of its greater size, it is carried only on the LUDA Class destroyers.



Captain Li Changming in Command.

The principal surface combatants appear intended primarily as missile platforms, offering greater operational range and better sea-keeping qualities than the small missile boats. The fleet of small missile boats has the advantages of speed and numbers. It suffers, however, from a limited ability to operate in bad weather or very far from shore. In encounters with Nationalist surface forces in the Taiwan Strait in the 1950s and 1960s, CPLA small craft, like the infantry, employed tactics emphasizing night fighting, surprise, and encirclement. By concentrating large numbers of missile boats on an enemy force approaching China's coast, the CPLA Navy might succeed in saturating the enemy's defenses through sheer numbers.

The CPLA Navy has a number of weaknesses including its critical shortage of SAM and ASW capabilities making its ships vulnerable to air and submarine attacks and modern antiship missiles. There is an absence of forward observation capabilities on combatants and the Navy relies on a Soviet missile, developed in the late 1950s, that is

vulnerable to electronic countermeasures. Large combatants are also handicapped by obsolete or rudimentary electronics. Guns are optically sighted, and command, control and communication capabilities are very limited. In short, CPLA ships would not survive an encounter against a modern naval force. Purchase of electronic equipment and missiles from foreign suppliers could improve the capabilities of surface ships.

3. ANTI-AIR WARFARE

The Chinese are developing a shipborne surface-to-air missile (SAM) but it is not yet operational. Ships rely on anti-aircraft guns, but the primary means of air defense is the shore-based Naval Air Force. These interceptors, however, are obsolete and have limited bad weather and night operational abilities. Naval bases and shore installations themselves are protected by anti-aircraft artillery and, in some cases, by SAMs. Chinese ships are vulnerable to air attack especially when beyond the range of the Naval Air Force.

4. AMPHIBIOUS WARFARE

The Navy has a sufficient number of conventional amphibious ships and craft to lift a force of over 30,000 troops and some equipment in a regional (less than 30 hours of transit) amphibious assault.

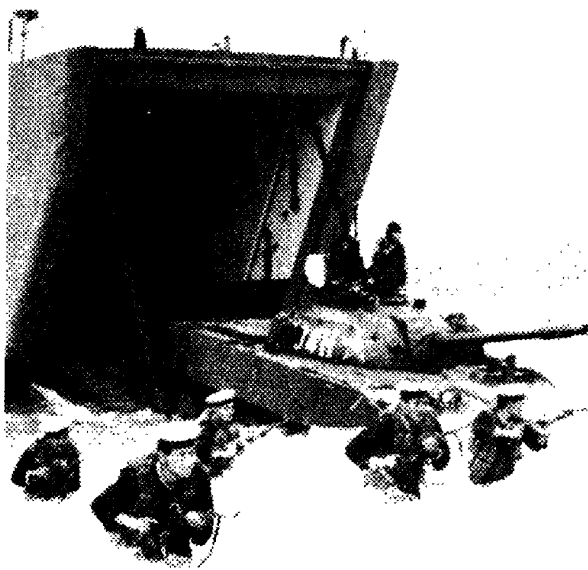

"Naval Infantry" — the Marines.

Once a port is secured, hundreds of merchant ships and thousands of motorized junks could be used in an administrative lift of support personnel and

heavy equipment. Successful employment of an amphibious force against a defended shore requires air and naval superiority in the objective area. An amphibious landing is always a hazardous enterprise, and success would depend on:

- determination and defensive strength of the enemy,
- limitations imposed by the size and age of the inventory of amphibious ships and craft, and
- acceptable ratio of assault forces to defenders.

5. MINE WARFARE

Little emphasis has been put on mine warfare and little information is available on the types or numbers of mines available to the Chinese Navy. Mines could be laid by most naval ships as well as by trawlers and junks. While the Chinese could deploy large numbers of mines, they probably would experience difficulties in clearing them because of the lack of technology and modern ships designed for that purpose. The primary mine warfare ship is the Soviet style T-43 Class minesweeper, an effective ship against some types of mines but obsolete by Western or Japanese standards.

6. COASTAL DEFENSE FROM SHORE INSTALLATIONS

Coastal artillery units, patterned along Soviet lines, support naval air and afloat forces. They are thought to be organized as independent regiments but it is not known if they are subordinate to the Navy. Stationed in the vicinity of the various ports and naval bases, these coastal artillery units work in close cooperation with ground force artillery units.

The most effective coastal defense weapon is the CSS N-2 cruise missile. It has a range of 75 kilometers and a radar/infrared homing seeker. While a formidable weapon, it is based on a Soviet design of the late 1950s. It is generally deployed only in defense of the most critical industrial and port areas of China.

7. NAVAL AVIATION

The primary mission of Naval Aviation is air defense of naval installations and surface forces. The force is land based and can provide only close-in support. Secondary missions include maritime reconnaissance, tactical support of the fleets with anti-shipping bombing and torpedo attacks, and support of amphibious operations.

The majority of the aircraft are air defense fighters. There are also a few intermediate-range jet bombers and a moderate number of medium-range jet bombers and attack aircraft. Order-of-battle figures in the CPLA Air Force chapter of this handbook include aircraft assigned to Naval Aviation. A

list of naval combat aircraft, by type, includes:

- Bombardment: Intermediate-range B-6/Tu-16/
BADGER
Medium-range B-5/Il-28/BEAGLE
- Air Defense: F-5/MiG-17/FRESCO
F-6/MiG-19/FARMER
F-7/MiG-21/FISHBED
- Surface Attack: A-5 FANTAN

The close coordination required between air force and naval force defense operations probably necessitates the operational control of naval air defense units by the CPLA Air Force. Other naval air units are responsible directly to naval headquarters in Beijing through the three fleet headquarters.

SECTION F — LOGISTICS

Although much naval equipment represents either Soviet designs of the 1940s and 1950s or Chinese modifications of such designs, all of it is produced in China and can be maintained, repaired, or replaced. China is able to produce hulls and engines, but cannot as yet equip its warships with up-to-date electronic gear. Ships are constructed and repaired in shipyards from Dalian in the north to Guangzhou in the south, with at least one major shipyard for each of the three fleets. A major development in logistics capability is the use of replenishment ships, discussed in sections D.1 and E.2.

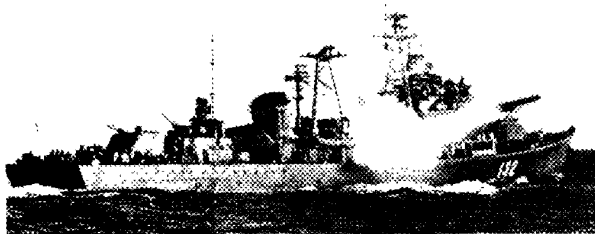

Combatant Launching Guided Missile.

SECTION G — TRAINING AND SCHOOLS

1. GENERAL

During the Cultural Revolution, relatively informal, on-the-job training was emphasized. The trend in the 1980s is toward formal training and attainment of uniform standards for all personnel from basic recruits to senior cadres. Old schools have been reopened and expanded, and new ones, such as a 4-year Naval Academy to train basic naval cadres in Guangzhou, have been founded.

2. RECRUITMENT

The source of naval recruits is not clear, but they are probably drawn from coastal fishing communities and from graduates of urban junior and senior middle schools. The advantages of recruiting seamen from fishing settlements are obvious. But such recruits are even less likely than youth from farming settlements to have had much formal schooling, or, if they come from anywhere south of the Changjiang River, to be at all fluent in standard Chinese.

The three fleets are known to operate schools to train seamen in various naval specialties. Once assigned to an occupational specialty and a unit, the recruit can expect to spend the rest of his naval career in that specialty and unit. CPLA members with technical qualifications may extend their duty once they have completed their initial term of enlistment, and it appears that on many naval ships a substantial portion of the crew is composed of such personnel. This reduces the burden of training replacements.

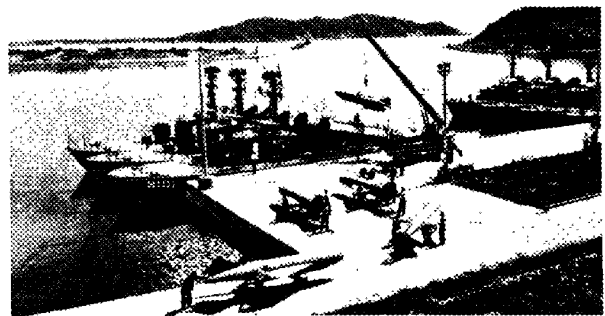

Loading Missiles at a Naval Station.

3. TRAINING

During the 1960s and 1970s, officers were drawn from the ranks, and received formal training ranging from a few months to several years. In the 1980s, officers are still promoted from the ranks, but must now attend a regular academy for up to 4 years, and pass formal job qualification examinations. Military academies, both general command and specialized technical schools, are now open to middle school graduates who score sufficiently high on the nationwide university entrance examination. The oldest school for naval officers is the Naval Academy at Dalian, which was founded in 1950 and initially devoted to training CPLA ground forces officers as naval officers. Nanjing is the site of a higher level school, sometimes referred to as a War College, for senior cadres. Submarine cadres attend a special 4-year academy in Qingdao, while naval aviators have their own special schools.

Training is a major activity on all ships. The Navy trains in a 10-month cycle, similar to that of the ground forces, which culminates with

multiship exercises in the autumn. In training, considerable emphasis is put on night and foul weather operations.

CHAPTER 4

AIR FORCES

SECTION A — ORGANIZATION AND COMMAND AND CONTROL

1. ORGANIZATION

The CPLA Air Force, with approximately 490,000 personnel, is organized into air districts. There are 11 air districts covering the same general areas as the military regions. Strength of individual air districts is determined by their proximity to potential threats; therefore, the strength of the Shenyang, Beijing, Nanjing, and Guangzhou Air Districts is greater than other air districts.

The largest operational unit within the Air Force is the air division, which is usually divided by the three-in-one principle with each air division consisting of three regiments, each regiment consisting of three squadrons, and each squadron consisting of three flights.

2. COMMAND AND CONTROL

The Air Force Headquarters in Beijing exercises direct command responsibility over each air district with no intervening level of command. The military region headquarters probably exerts some degree of control over regional air forces for overall coordination of the military effort. Figure 14 is an estimate of the command relationships from the Central Military Commission to air division levels.

SECTION B — AIRCRAFT AND WEAPONS

1. AIRCRAFT

China's aircraft inventory, although large, consists mainly of aircraft dating from the mid-1950s. The bomber force includes some 100 B-6 (Tu-16/BADGER) intermediate-range jet bombers and over 400 B-5 (Il-28/BEAGLE) medium-range jet bombers. The air defense system includes more than 4,100 aircraft with F-5 (MiG-17/FRESCO) and F-6 (MiG-19/FARMER) jet fighters comprising the bulk of the force. The F-6, first produced in the 1950s, is the backbone of the fighter force. Over 100 relatively advanced F-7 (MiG-21/FISHBED) are included in the interceptor inventory. It is mainly a clear air-mass, daylight force, with only a small percentage of the aircraft having an all-weather capability. The tactical bomber force has over 400 MiG-15/FAGOT and A-5/FANTAN fighter-bombers. The A-5 is designed and produced by the Chinese and is derived from the MiG-19/FARMER.

The Chinese aircraft inventory is tabulated in ap-

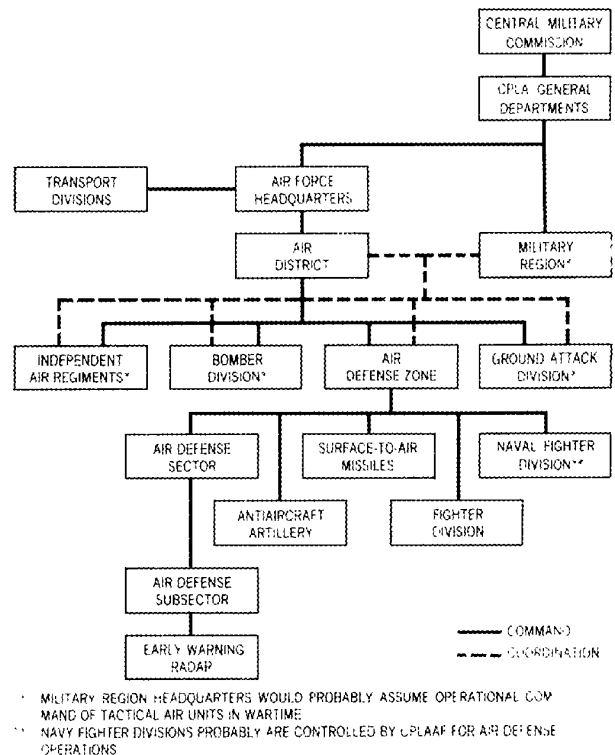

Figure 14. Organization of CPLA Air Forces.

pendix W; silhouettes of representative aircraft are depicted in appendix X.

2. WEAPONS

Some F-6 and F-7 fighters are armed with an air-to-air missile in addition to cannons. The missile appears to be a Chinese version of the Soviet ATOLL, an infrared homing missile based on the US "Sidewinder."

SECTION C — DOCTRINE AND TACTICS

1. DOCTRINE

The primary mission of the CPLA Air Force is the defense of China with the preponderance of the force being fighter/interceptor aircraft. Tactical missions include air-to-ground support and interdiction of enemy targets, military airlift, and reconnaissance. The intermediate-range and a small number of the medium-range bomber forces probably have a limited nuclear-strike capability, but they are designed primarily for conventional bombing operations.

2. TACTICS

a. Fighter Tactics

The basic fighter tactic is multilayered flights with two elements of aircraft per flight providing mutual support at as many as four different altitudes. Of the leading two aircraft, the leader is the offensive aircraft, with the other providing flight defense and massing of firepower. The Air Force has a limited but growing air-to-air missile capability with ATOLL-type heat-seeking and possibly ALKALI-type beam-riding missiles. Most of the force, however, probably continues to be fitted with cannon only.

b. Bomber Tactics

Bomber crews are considered proficient in both low- and high-level bombing. Enemy capabilities would greatly influence tactics. Mass low-level attacks against enemy targets would be multidirectional at varying speeds and altitudes and high-level bombing would be conducted in formation or trail. Ground attack missions will be predominately pre-planned sorties, because China lacks a ground or airborne forward air control system. Therefore, in a fluid battlefield situation, tactical bombers would be much less effective. Night operations are limited to the BEAGLE and BADGER force.



B-6/Badger Being Loaded with Bombs.

SECTION D — CAPABILITIES

1. BACKGROUND

The Air Force is the third largest in the world and can provide effective air defense against any potential Asian aggressor with the exception of the Soviet Union. The tactical bomber force is capable of providing interdiction of enemy lines of communication and very limited support to ground forces in combat.

2. AIR-TO-AIR COMBAT

In daylight and good weather the Air Force could put up hundreds of F-6 interceptors, as well as sub-

stantial numbers of F-5s and some F-7s. These planes would depend on ground controllers to guide them to the vicinity of their targets. Recent training and exercises have emphasized countering attacks at low level from many directions, and improving coordination between interceptors and antiaircraft artillery and missile units.

The Air Force has a very limited number of all-weather F-6 and F-5 aircraft. A new fighter, the F-8/FINBACK, has been under development since the early 1970s. It is considered an all-weather interceptor and will be armed with an improved air-to-air missile.

Chinese Air Force pilots normally fly fewer hours annually than Western air forces consider necessary to maintain combat proficiency. In 1978, for example, the Air Force planned for less than 100 hours flight time per pilot. Combat capability is further hampered by limited communications and electronic countermeasures capabilities. Some of these limitations result from a lack of funds and could be reversed quickly if budget restraints were lifted and up-to-date equipment were purchased from abroad.

The central question in assessing the capabilities of China's Air Force is how far sheer numbers go to counter obsolescence. Much, of course, depends on the potential enemy. While the Chinese Air Force could not defend the country against a large-scale attack by a modern air force, such as that of the Soviet Union, it would probably be a match for any regional air force.



F-6/Farmer and F-7/Fishbed Fighters on Parking Ramp.

3. TACTICAL AIR SUPPORT

Chinese recognition of the importance of tactical air support is indicated by the development and deployment during the 1970s of the supersonic A-5 fighter-bomber. It normally carries four 550-lb bombs as well as air-to-ground rockets. Tactical air support can also be provided by smaller numbers of MiG-15s adapted to carry bombs, and by B-6, B-5, and a few Tu-2/BAT bombers. These aircraft can attack enemy artillery emplacements, armored vehicles, trenches, fortifications, and troops. Helicopters provide a uniquely Chinese form of tactical air support, scattering antitank mines in front of attacking tank columns.

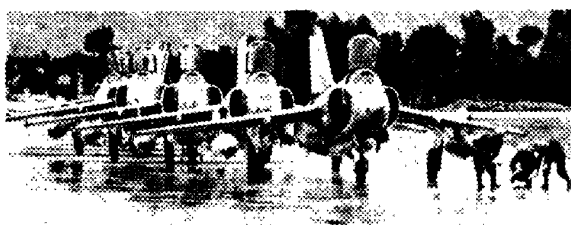

A-5/Fantan Fighter-Bomber Pilots Rehearse Mission.

Although improved coordination between ground forces and aircraft has been one of the primary goals of recent military exercises, China still has neither the communications equipment nor the doctrine and organization necessary for an effective forward air-control system. Accounts of the large-scale military exercise in North China in November 1981 described an elaborate, preplanned and meticulously scheduled event: "They came from different airfields and, although there were differences in flying distance, airspeed, and wind velocity and direction on the route, they arrived on time at the appointed air space. Various squadrons coordinated with the ground troops, attacking from different altitudes in the same air space and, coordinating like a fighting collective, shot at and bombed with almost perfect accuracy the various fixed and moving targets which the ground forces asked them to destroy." Therefore, as mentioned in section C.2 above, tactical air strikes would be preplanned and directed against enemy rear positions and lines of communication.

Given their serious limitations, the general principle of Chinese tactical air support is to avoid confrontations with the enemy's strength while attacking the weaknesses. Rather than engaging in direct attacks on battlefield targets, the Chinese instead emphasize pursuing an indirect approach, which focuses on destroying key enemy logistical supply lines and rear positions. In air combat

against the USSR, China's lack of air superiority would seriously inhibit carrying out even this modest tactical role.

4. BOMBING

China's intermediate-range bomber force is composed of about 100 B-6s and a few Tu-4/BULL. The Tu-16 was designed in the late 1940s and first flew in 1954. The Chinese produced their first copy in 1968, and production has continued at a modest pace since then. It can carry a 9,000-kilogram load of bombs, and has a maximum range of 4,800 kilometers. The Tu-4 is a Soviet copy of the US B-29.

Although some relatively small nuclear devices have been dropped from aircraft in nuclear tests, China is not known to have any intention of using the B-6 as a strategic bomber. Rather, these aircraft appear intended for an essentially tactical role, directed at an invader's rear areas or supply routes. A Chinese account of a 1981 military exercise described high altitude fighter airplanes used in coordination with "attack planes" and ground forces to provide tactical support to the tank forces. Mid-altitude bombers were described as conducting large-scale bombings of "enemy" bases, while low altitude attack planes initiated intense raids on "enemy" tanks and artillery. Bombers and helicopters also laid mines from the air to deter "enemy" attacks. The same account described a mass attack by bombers flying "in combat formation," and releasing "wave after wave of bombs" on the target. Accounts of bomber pilots usually stress their skill in accurate navigation on long distance flights.

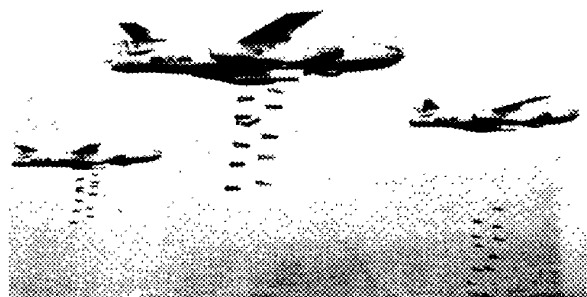

B-5/Beagles Conduct Bombing Attack.

5. RECONNAISSANCE

The Air Force has specialized reconnaissance squadrons which fly camera-equipped F-6s and B-5s. Some B-6 aircraft may also be employed for reconnaissance. Cameras as well as photo processing and photointerpretation systems are based on Soviet technology of the mid-1950s, and photo-reconnaissance capabilities are thought to be modest by contemporary standards.

6. AIR TRANSPORT

The transport fleet consists of some 550 light and medium planes, mostly of Soviet design of the 1940s and 1950s. Less than 50 of these can carry more than 100 troops or have a range of more than 1,800 kilometers. There are over 300 Y-5/An-2/COLTs, a plane which carries 14 passengers and has been produced in China since 1957, about 100 ex-Soviet planes including the Li-2/CAB, Il-14/CRATE, Il-18/COOT, some An-12/-24/-26, and 18 Tridents. In addition to producing the Y-5/An-2/COLT, China produces the turboprop Y-8/An-12/CUB, and may also produce the turboprop An-24 and An-26. There are about 100 of these last three types in the Air Force inventory. In addition, some 300 helicopters are available for transport operations. In an emergency these could be supplemented by the civil aviation fleet of CAAC (General Administration of Civil Aviation of China), which includes 3 Boeing 747s, 10 707s, about 20 Tridents, and up to 100 Li-2s, Il-12s, Il-14s, Il-18s, and An-24s. In the fall of 1982, the CAAC ordered 10 Boeing 737s and two more 747s which would be available to the Air Force in a national emergency.

China's air transport capability relative to its ground and air forces is presently extremely limited. The entire Air Force, even if the civil air fleet were mobilized, would be hard pressed to carry the three airborne divisions. On its own, the Air Force could transport and supply a small force, on the order of one or two regiments, either within China or in the immediate vicinity.

7. AIRBORNE OPERATIONS

Airborne operations are covered under specialized operations in the ground forces chapter. For a detailed discussion of airborne operations, see p. 47.

SECTION E — LOGISTICS

1. GENERAL

The Air Force logistics system falls under the CPLA's General Logistics Department, and is modeled on Soviet systems of the 1950s, with aircraft returned to factories for major overhauls. China domestically produces all its combat and most of its military transport aircraft, but replacement parts are reported to be in short supply. The Chinese versions of Soviet jet engines are reputed to require more frequent overhaul and replacement than the original models, due to metallurgical problems. Supplies and maintenance are adequate to

sustain the Air Force's normal moderate pace of operations, but the ability of the system to cope with the stresses of sustained combat is uncertain.

2. AIRFIELDS

There are approximately 335 operational airfields in China. The majority of these airfields are located east of the 108-degree meridian in the most populous area of China. Most of the military airfields — those used by the various air force operational units — have runways of 1,800 meters or more and are generally used in an air defense posture.

The following is a description of Chinese airfields.

Runway Length (in meters)	Runway Surface*			Total
	P	T	N	
4,000 and over	6			6
4,000 — 3,600	2			2
3,600 — 3,000	20	3	1	24
3,000 — 2,700	17			17
2,700 — 2,400	57	1	1	59
2,400 — 2,100	81		3	84
2,100 — 1,800	35	3	11	49
1,800 — 1,500	11	1	11	23
1,500 — 1,200	13	4	13	30
under 1,200	12	1	13	26
under construction				5
seaplane stations				2
heliports				4
highway strips				7
	254	13	53	338

* P = Permanent
T = Temporary
N = Natural

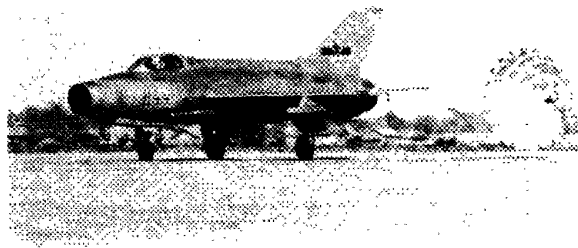

F-7/Fishbed Returns from Flight Operations.

SECTION F — TRAINING AND SCHOOLS

1. TRAINING

a. Pilots

Pilots are trained in a four-stage 36-month program. Candidates must be senior middle school graduates between the ages of 16 and 18, who are in top physical condition. They spend 8 months at a preparatory school where they study military, political, and general scientific subjects, followed by 4 months at an aviation school, where classroom instruction in principles of aviation, air navigation, aircraft construction, and avionics is given. They

then receive 12 months of flight training in CJ-6 (derived from Soviet Yak-18 — MAX) primary training planes. Successful candidates follow this with 12 months of advanced flight training in either jet fighters, bombers, or transport planes. By the end of the program the pilots have 240 hours of flight time. They then go on to operational units, where they undergo a further 24 months of on-the-job training, before being considered fully qualified.

Between 1966 and 1978 most pilots were recruited from "heroes" and "models" of various units throughout the CPLA. Political activism was a major criterion for selection. Their formal training was both brief (24 months at most) and narrow, and most of their skills were acquired while on the job. It is difficult to introduce new technology and tactics to such personnel, and, since 1978, much effort has gone into raising the educational level of Air Force members, with weekly classes on such matters as elementary physics, mathematics, and electronics. Considerable emphasis has also been put on increasing such basic tactical skills as gunnery, formation flight, and low-level flying.

In unit training, the goal since 1979 has been to replace stereotyped, formalistic training with programs reflecting the conditions and demands of actual combat. Combat formations are used whenever possible; target drones no longer fly on fixed courses at constant speed; and pilots practicing ground attacks are free to attack from varying altitudes and directions. The capabilities of foreign, and especially Soviet aircraft, are discussed, as are foreign air tactics. Pilots and commanders are also encouraged to find ways to make their admittedly obsolescent aircraft as effective as possible. A further goal of training is to raise the general level of technical and tactical skills, so as to be ready to take full advantage of more advanced equipment when it becomes available. Joint exercises and combined-force operations have also been the object of much attention. These have ranged from practice coordinating radar, anti-aircraft artillery, and surface-to-air missiles with interceptors in air defense exercises, to large-scale military exercises involving ground forces and interceptors, attack planes, bombers, helicopters, and paratroops.

b. Maintenance Personnel

Maintenance personnel are divided into three grades. The lowest, "maintenance personnel," are senior or junior middle school graduates, and receive 8 to 12 months formal training, followed by 2 to 3 months of on-the-job experience. The next grade, "mechanics" or "technicians," are senior middle school graduates and a few selected

"maintenance personnel." They go through a 24-month training program. The highest grade, "engineers," selected from senior middle school graduates and outstandingly proficient mechanics, attend the 48-month program at the CPLA Air Force Engineering Academy in Xi'an.

2. SCHOOLS

Since its establishment and rapid growth in the early 1950s, the Air Force has maintained an extensive system of flight and technical schools. By the end of 1953 there were 18 flight and technical schools, which often employed former Nationalist Air Force officers as instructors. While it is not known how many schools now exist, it is almost certain that each Air District has a flight school and a complement of basic technical and specialized schools (for aircraft maintenance, communications and electronics, anti-aircraft artillery, and so forth). There are also a number of specialized schools recruiting from the whole country and serving the Air Force as a whole. Two of these, the Air Force Engineering Academy and the Air Force Anti-aircraft Artillery Institute were identified in 1980 as among the nation's 22 key military technical institutions, having first priority in enrolling middle school graduates. The status of others, such as the Radar School in Wuhan which was reported to have graduated nearly 1,000 students in 1981, is not clear.

Since 1981 students entering military technical academies and schools have been selected from senior middle school graduates, who have achieved high scores on the nationwide college entrance examination. This reflects the national policy of raising the educational level of military personnel as a requisite for modernization, and is especially significant for services such as the Air Force which depend so heavily on technically qualified manpower. A 1981 Chinese press report said that in the previous 3 years the CPLA Air Force had reopened more than 10 academies and schools closed because of the "bad influence" of Lin Biao and the Gang of Four. It also claimed that the pilots graduating from the 3-year training program and recruited from 18- to 20-year-old senior middle school graduates rather than heroic members of infantry companies were "not only young but of much higher quality."

There are also intermediate aviation schools, offering a 6-month course for flight group leaders, as well as an unknown number of Air Force academies, with a 12-month program to train cadres at the regimental level and a small number of commanding cadres at the division level. High-level Air Force commanders also attend the military academies and command schools common to the whole CPLA.

CHAPTER 5

BALLISTIC MISSILE FORCE

SECTION A — ORGANIZATION

1. HISTORICAL BACKGROUND

As early as 1956, then CCP Chairman Mao Zedong proposed significant changes in China's allocation of national resources in order to finance the development of guided missiles and nuclear weapons in the hope of avoiding "nuclear blackmail." The desire to attain status as an independent great power was thus a factor in Chinese national policy since the early days of the People's Republic.

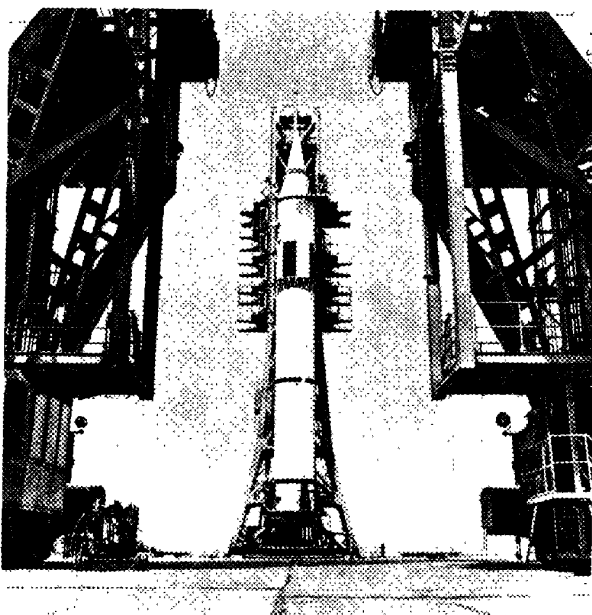

CSS-4 ICBM at the Launch Pad.

By 1958, the CPLA had established a guided missile "seed" unit, and during the period 1958-60 the unit received samples of Soviet strategic and tactical rocket and missile systems which are believed to have included limited numbers of FROG (free rocket over ground) 1/2, SS-1 SCUD A/B, SS-2 SIBLING, and possibly the SS-3 SHYSTER weapons systems. These systems had conventional, high-explosive warheads. Premier Zhou Enlai later named this new organization the "2d Artillery Unit," and "2d Artillery" soon became a generic term within China for various classes of guided missiles.

Although the Soviet Union had promised to assist Chinese development of guided missiles and nuclear weapons systems in 1957, Mao Zedong was reportedly unwilling to meet one of Moscow's conditions: the subordination of Chinese foreign and defense policy interests to a joint Chinese-Soviet Far Eastern Military Command. When Moscow failed to support Chinese interests during the 1958 offshore islands crisis, an impasse developed and relations between the two nations deteriorated. By 1961, most Soviet technicians involved in 2d Artillery development had left China.

Following this reversal, China is thought to have reordered its missile development priorities and may have abandoned any tactical FROG and SCUD programs in order to concentrate on more advanced delivery systems such as the SS-2 SIBLING. Such a development strategy would have concentrated China's limited resources on a program likely to yield a strategic nuclear deterrent, and would have been in accord with Mao's belief that tactical nuclear conflict was inherently uncontrollable and would inevitably escalate into total nuclear war.

2. CURRENT STRATEGY

As part of their military modernization process, China seeks to develop military capabilities adequate to deter or defend against the great powers of the world. Although their strategic forces are of a modest level, China undoubtedly believes that this force affords it a measure of geopolitical leverage and a certain independence from nuclear blackmail by the two superpowers — the United States and the Soviet Union.

Reevaluation of Maoist attitudes toward nuclear strategy and the nature of a future nuclear war indicates that China may be considering the feasibility of supplementing its strategic nuclear arsenal with tactical nuclear weapons.



Missile Unit Training for Launch.

SECTION B — WEAPONS SYSTEMS

1. NUCLEAR WEAPONS

China detonated its first nuclear device in October 1964 and by June 1967 had successfully tested a thermonuclear (hydrogen) bomb. China now has between 225 and 300 nuclear warheads, including fission warheads ranging from 20 to 40 kilotons and thermonuclear warheads ranging from 3 to 5 megatons. These warheads can be delivered by both land- and sea-based missiles, as well as by conventional bomber aircraft. The Chinese are continuing to develop their already significant nuclear arsenal.

2. DELIVERY SYSTEMS

China appears to be developing alternate delivery systems. However, land-based surface-to-surface missile (SSM) systems are currently China's only credible means of strategic nuclear delivery.

Although the CPLA Air Force and Naval Air Force include several hundred Il-28 BEAGLE and Tu-16 BADGER medium- and intermediate-range bomber aircraft — all of which are theoretically capable of strategic nuclear weapons delivery — it is unlikely that these obsolescent aircraft could successfully penetrate the sophisticated air defense networks of modern military powers. It is thus improbable that China's air forces have a strategic nuclear delivery mission.

Since the termination of Soviet military assistance programs in 1960, China is believed to have developed and operationally deployed at least five distinct land-based strategic SSM systems. The DONGFENG (East Wind)-1 (DF-1) was probably the first Chinese prototype to have been developed from SSMs supplied by the Soviet Union from 1958 to 1960. A Chinese variant of the Soviet-supplied SS-2 SIBLING SSM, equipped with a conventional high-explosive warhead, probably constituted the DF-1 and may have been deployed among Special Technical Units of the CPLA 2d Artillery Corps during the early 1960s — before China had deployed a compatible nuclear warhead. The characteristics and an illustration of the DF-1, and of the other four systems described below, are shown in appendix Y. The DF-1 may have remained deployed beyond the advent of the DF-2, perhaps even into the 1970s. To accomplish this, China may have retrofitted DF-2 warheads to the DF-1.

China's first successful nuclear SSM test in October 1966 probably used the single stage DF-2, which is similar to the Soviet SS-3 SHYSTER SSM. This was the first strategic SSM to be widely deployed in China but is probably being phased out and replac-

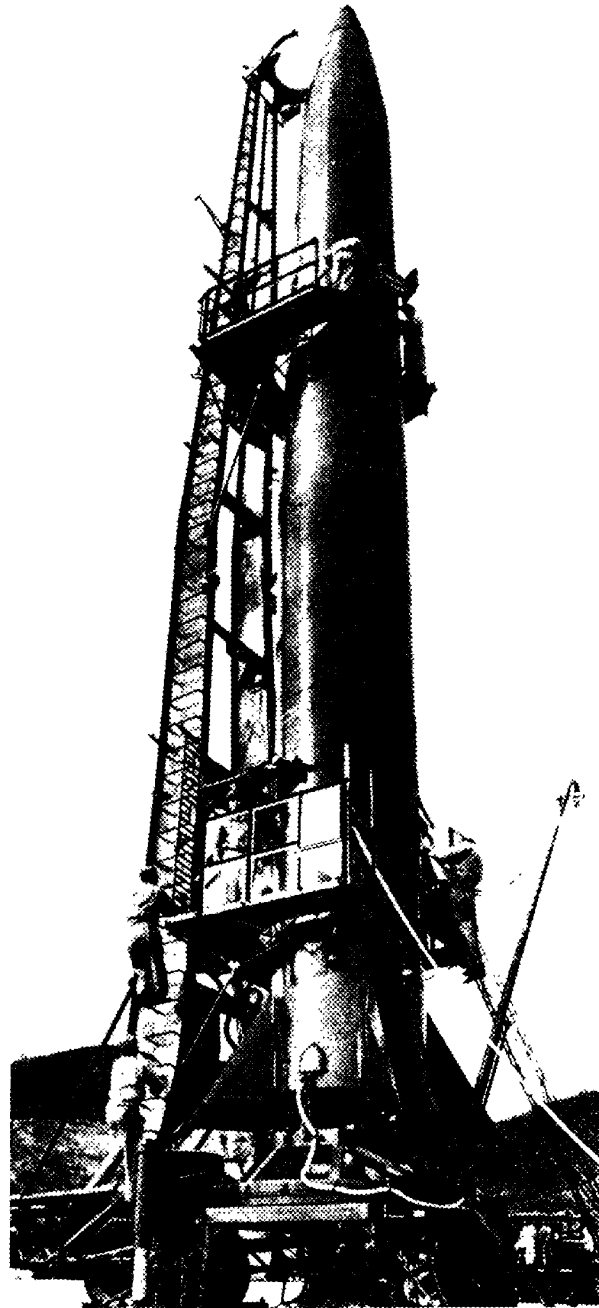

CSS-1 Missile with Warhead on Transporter/Erector

ed by the DF-3. The DF-3 was first tested around 1969 and deployed in the early 1970s. The use of storable propellents in the DF-3 permits more flexible operation and greater "hold" times at high alert status than were possible with the DF-2.

The DF-4 is probably a two-stage version of the DF-3 and apparently uses the same propellents. The DF-5 is China's largest two-stage ICBM and was tested, with a substantial amount of publicity, in two May 1980 flights from central China to the vicinity of the Fiji Islands about 15,000 kilometers away. It is the only Chinese SSM system capable of reaching targets throughout most of the United States. It uses storable bi-propellents and has a probable warhead yield of from 4 to 5 megatons.

SECTION C — SPACE SYSTEMS

A booster variant of the DF-4 — known in China as the CHANGZHENG (Long March)-1 (CZ-1) — was used in 1970 and 1971 to launch the first two Chinese earth satellites. Subsequent Chinese satellites with obvious military reconnaissance capability have been launched by a booster variant of the DF-5, known as either the CZ-2 or FENGBAO (Tempest)-1 (FB-1).

A three-stage variant of the two-stage CZ-2 booster — known in China as the CZ-3 — was tested on several occasions in 1984, each time putting communications satellites into orbit. There is no evidence that China plans to deploy this booster in a strategic ICBM configuration. It is designed to launch satellites into geosynchronous orbit and put large-scale spacecraft into low orbit.

Chinese space launch vehicles and their characteristics are shown in appendix Y.

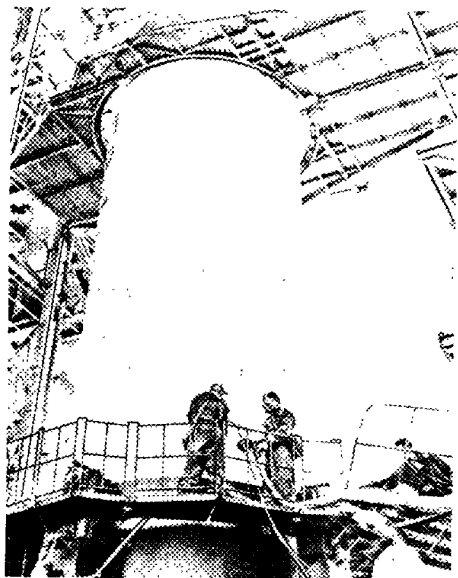

Loading Fuel on the FB-1 Space Booster.

SECTION D — FUTURE WEAPONS SYSTEMS

1. BALLISTIC MISSILE SUBMARINES

China has long been interested in acquiring a fleet of ballistic missile submarines (SSBs), and in 1958-59 first considered and later rejected Soviet proposals for a joint Soviet-Chinese Far Eastern Naval Command that would have included SSBs. By 1964, China had successfully assembled a single GOLF Class SSB from parts supplied earlier by the Soviet Union. In 1982, China test-fired its first submarine-launched ballistic missile (SLBM) — an intermediate-range device — from a GOLF Class submarine. China is reported to have at least one XIA Class SSBN which can carry 16 SLBMs in sea trials.

2. LAND-BASED SSM

Solid propellant land-based SSMs may be under consideration or in the early stages of development. The most likely new systems to be developed would be a follow-on to the DF-2 or DF-3 and an ICBM follow-on to the DF-4. There are indications that China may develop tactical nuclear delivery systems.

SECTION E — CAPABILITIES

1. FORCE SIZE

The 2d Artillery Corps is thought to consist of over 100,000 personnel responsible for over 100 launchers. Most of these launchers are mobile DF-2s and DF-3s deployed at scattered sites throughout China. China's ICBM force is probably small, with no more than 10 launchers.

2. CREDIBILITY

From the publicity which has attended China's nuclear and thermonuclear weapons tests, including official photographs released by the Xinhua News Agency and technical data published in Chinese and Western sources, it can be argued that China has both the technical capability to produce a variety of types and yields and a credible stockpile of nuclear weapons. The development of the 2d Artillery, existence and test firings of several classes of strategic missiles, successful launchings (and several recoveries) of earth satellites by booster variants of strategic SSMs, and evidence of operational concepts that are part of China's nuclear strategy are all indications of Beijing's effort to propagandize its nuclear credibility.

The Chinese have publicly and repeatedly renounced any first use of nuclear weapons, but have promised to counterattack with such weapons if

nuclear weapons are used against their nation. Limitations in range, accuracy, response-time, and other technical factors, which might reduce the effectiveness of Chinese nuclear weapons against counterforce targets, have apparently been taken into consideration. Any Chinese retaliatory strike would probably be directed against countervalue targets (cities and industrial centers) on the periphery of China. In the past, China enhanced its credibility in Korea, India, on the Sino-Soviet border, and in Vietnam through its willingness to resort to military force in a rational defense of its national interests.

3. SURVIVABILITY

The credibility element of the Chinese nuclear threat has been further enhanced by the likelihood that enough CPLA missiles would survive a preemptive strike to enable China to retaliate and to inflict a high level of damage on the enemy. The survivability of China's nuclear forces rests on a number of factors which include mobility, terrain, modes of deployment, hardness, deception, and uncertainty.

The mobility of China's single-stage DF-3, DF-2, and any still-operational DF-1 SSMs, is assured where road and rail transport are available. Missile launch units may practice quick-reaction responses to sudden alert notification by withdrawing from their normal garrisons. Secretly deploying over periods of several hours or days to new launch positions that are unknown to the enemy, they may move hundreds of kilometers away from their home bases. Mobile SSM exercises and operations have been described in some detail in fictional accounts and purported news reports. In one purportedly true account, an SSM launch unit left its base, transported

all of its personnel and equipment by rail and motorized means to a new launch site several thousand kilometers away, and then launched a salvo of missiles. Published photographs of missile exercises

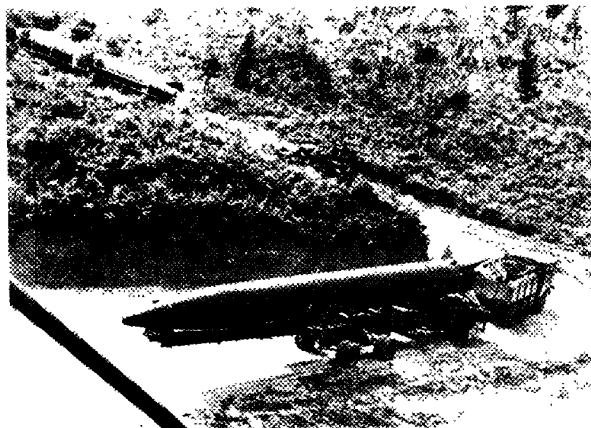

DF-2 with Reentry Vehicle on Transporter/Erector in Foreground, DF-3 in Background.

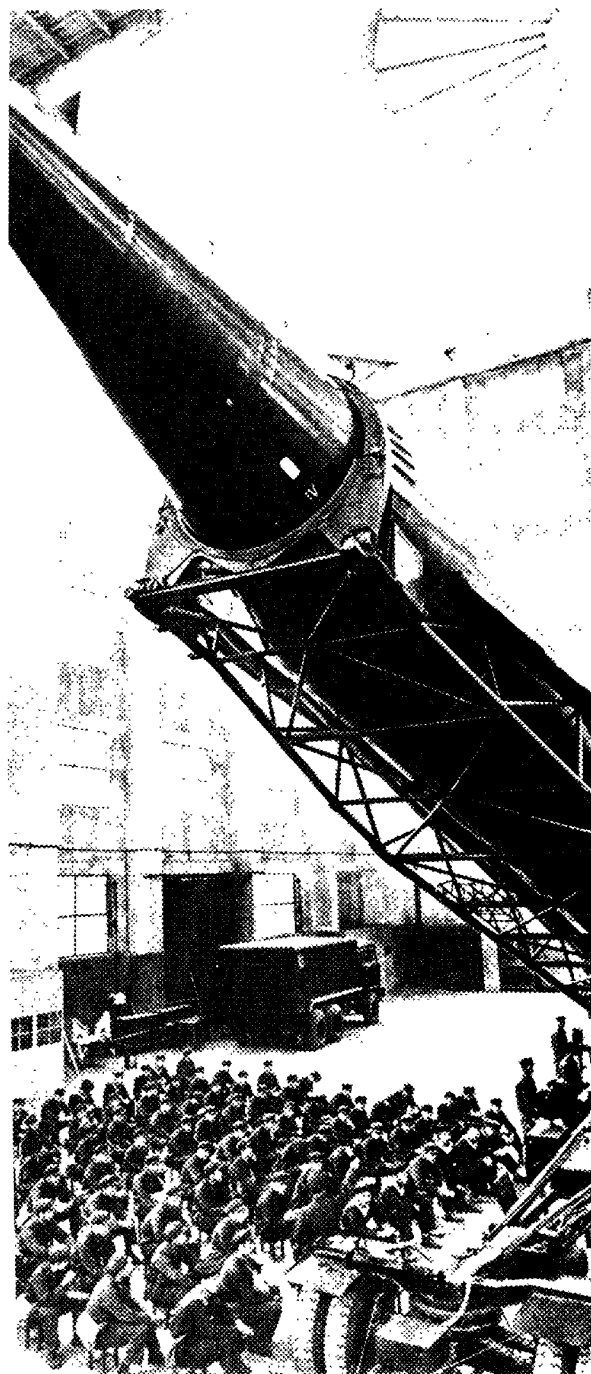

Lecture at a Missile Technology College.

showing prime movers and other heavy, all-wheel drive vehicles suggest that Chinese missile units have good off-road mobility and could circumvent impeded road or rail nets in at least some parts of China.

The Chinese media gives evidence that most 2d Artillery missile launching units are deployed within or conditioned to operate in extremely rugged terrain. Dense jungles, deep forests, remote and isolated villages, narrow valleys, and steep mountains have been reported in the vicinity of missile launch sites. Such deployment strategy would encumber

enemy reconnaissance and might also exploit terrain features for protection against preemptive attacks. Reinforced steel doors, concrete hardening techniques, and other design strategies probably enhance the survivability of Chinese bases. The discussion in the Chinese media of humidity control problems overcome by 2d Artillery "tunnel maintenance squads" indicates the presence of hardened underground bases. The Chinese also have mentioned a strategy involving the "hare with several holes" which suggests that a missile launch unit might have a number of alternative bases.

CHAPTER 6

JOINT SERVICE CAPABILITIES

SECTION A — DOCTRINE

1. BACKGROUND

Traditionally the CPLA has emphasized individual unit training and operations. Where they have engaged in combined operations, it has been

principally ground forces combined-arms operations with the artillery, armored, and engineering arms supporting infantry operations. With regard to joint service operations, the Air Force and Navy occasionally have been used in coordination with the ground forces.



Heliborne Troops.

2. DEVELOPMENTS UNDER THE MILITARY MODERNIZATION PROGRAM

Since the mid-1970s, China has made efforts to improve the capability of the CPLA to fight a modern war, which is characterized as a three-dimensional conflict on land, sea, and air, fought in the rear as well as in the front. As a result, the Chinese are paying more attention to military training, are emphasizing the antitank aspects of infantry tactics, and are adding combined-arms and joint service operations to the traditional single service arm maneuvers. Critical to this entire process is the training of commanders in combined-arms operations.

Training manuals for combined warfare based on Western and Soviet tactical manuals are being developed. Ground force, naval, and air force commanders at the battalion level and above have received joint planning, logistical, and combat training. At least one combined-arms ground force unit has been formed consisting of an infantry battalion, a tank company, a 122-mm howitzer company, an 82-mm recoilless rifle company, an antichemical warfare platoon, a flamethrower platoon, and corresponding logistics squads. The objective of this reorganization is to improve the administrative and operational coordination and mutual support of the various services, arms, and specialized units and their capability to conduct operations under a unified battle plan and a centralized command.



Tanks in Pursuit

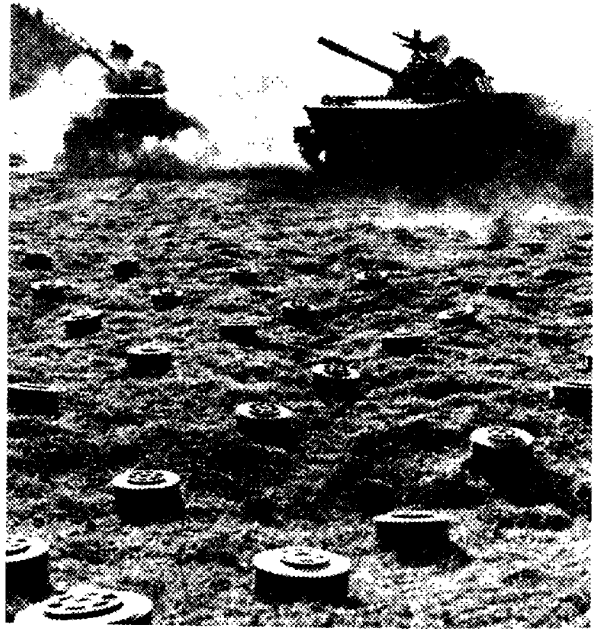

Antitank Mines.

There is little information on the specific tactics of combined-arms operations. It is known, however, that artillery is used extensively to provide direct support for frontline infantry forces. It provides preparatory fire to open gaps for friendly infantry troops to pass through, and to harass and destroy enemy reserve troops, weapons, and fortified positions.

CPLA armored forces can be employed in coordination with infantry, artillery, and engineering troops to break through enemy defenses. Tanks can also be organized as an assault echelon, advancing on and attacking the objective with the support of infantry forces. If the enemy defense becomes disorganized, tanks in the support echelon can be loaded with infantry troops to pursue the retreating enemy forces. When required, a reserve echelon made up of tanks and infantry can attack the enemy flank. Tanks can be used as a support echelon, providing fire support for an assault echelon composed of infantry and engineering troops. A motorized infantry regiment may also be organized as an immediate followup echelon to the tanks to protect transportation routes to the rear area, mop up enemy remnants and stragglers, and widen any gaps found in the enemy lines. The Chinese are believed to be modifying past armor doctrine with more integrated combined-arms operations being emphasized as a result of lessons learned from the 1979 Chinese invasion of Vietnam.



Tanks and Bombers.

Engineers are also used in coordination with infantry, artillery, and armored forces. In addition to their standard construction, bridging, maintenance, camouflage, and demolition duties, engineers are called on to support assault forces by removing land mines and other obstacles. In night operations they also provide illumination.

In joint service operations, airborne units belonging to the CPLA Air Force would be transported behind enemy lines by helicopter or combat-transport aircraft and attempt to carry out a combination of the following missions:

- prevent or delay enemy reinforcements from participating in the main battle;
- assist friendly forces in seizing and controlling strong points, and in encircling and destroying hostile forces;
- seize enemy tanks, artillery weapons, nuclear weapons launching sites, and signal communications facilities;
- destroy enemy logistical supplies and installations in rear areas;
- seize enemy tactical airfields and bridges; and
- assist friendly forces in river crossings and amphibious landings.

It was reported that during the 1979 Sino-Vietnamese border war, antichemical troops were assigned to support frontline infantry and artillery units in detecting poisonous gases and conducting decontamination procedures.

The CPLA hopes to develop a direct support role for the Air Force, working in close cooperation and coordination with the ground forces. The principal Air Force direct support mission is to attack enemy artillery emplacements, armored vehicles, trenches, fortifications, and troops. This mission, however, would be one of aerial bombardment and not a close air support mission as defined by the US military. In addition, the Air Force would be called on to lend indirect support by conducting bombing raids behind enemy lines to destroy transportation links, munitions factories, power plants, arsenals, granaries, and reserve forces.

Although there is frequent mention of the need for the Armed Forces to be prepared to fight a modern three-dimensional war, there is no indication of plans for a joint service role for the CPLA Navy beyond naval gunfire support for amphibious landings and providing amphibious lift.

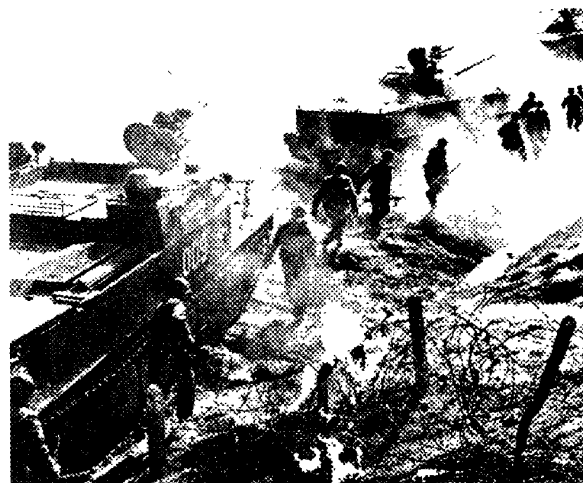

Infantry, APC's, and Tanks.

SECTION B — CAPABILITIES

1. BACKGROUND

There is very little information on which to base an appraisal of proven CPLA capabilities for conducting joint service operations because its forces have rarely been engaged in actual joint service combat.

2. JOINT SERVICE OPERATIONS

Although ground, naval, and air forces were used in the January 1974 operation to oust South Vietnamese forces from the Xisha (Paracel) Archipelago, there is no evidence of joint operations. Prior to the actual landing of ground forces, there were skirmishes between CPLA Navy ships and South Vietnamese naval forces, but there is no indication of a direct coordination between these skirmishes and ground forces operations. Air force support for the landing was apparently limited to bombing and strafing runs to soften landing areas.

The February-March 1979 Sino-Vietnamese conflict was principally an infantry and armored

engagement. The CPLA Navy apparently was not involved, and the Air Force was limited to reconnaissance and defensive patrols. Engineers removed land mines and concentrated artillery barrages cleared paths for coordinated infantry and armored attacks. There are indications that deficiencies in command, control, and communications caused problems in coordinating ground force operations. The Chinese are taking preliminary steps to correct these problems through improved training of commanders at the battalion level and above, and through the institution of large-scale joint operations exercises.



Antitank Minelaying Multiple Rocket Launchers

3. JOINT SERVICE EXERCISES

A noteworthy joint service exercise was conducted near Zhangjiakou, northwest of Beijing, in September 1981. Air and airborne forces participated in this exercise with infantry, artillery, antitank and air defense missile units, and armored, engineering, signal, antichemical, logistics, antiairborne and electronic countermeasure units. It was also reported that a few naval units participated in the exercise.

Precise timing and close coordination of all participating forces were emphasized throughout the exercise. In an effort to lend realism, the forces were divided into "red" and "blue" armies. The following characteristics of modern warfare were employed:

- conducting operations in the face of nuclear and chemical weapons;
- establishing air supremacy and using airborne forces;
- assembling tanks in broad and deep formations for high speed, multiple wave assaults; and
- simulating the coordination of air, ground, and naval forces in three-dimensional warfare.

In June 1982, another joint service exercise, held in the Ningxia Hui Autonomous Region, included a simulated tactical nuclear detonation and the use of airborne troops and air support in coordination with ground forces. Like the Zhangjiakou exercise, the missions of the participating units were well

planned and coordinated.

While such orchestrated exercises serve as valuable training in joint service operations, they are not synonymous with a CPLA capability to conduct joint service operations under actual combat conditions. Although China's conventional ground, naval, and air forces are increasingly participating in joint service maneuvers, there is no evidence that strategic ballistic missile units of the CPLA 2d Artillery Corps participated in these exercises.



Ready to Defend the Front Lines.

CHAPTER 7

UNIFORMS AND INSIGNIA — AWARDS AND DECORATIONS

SECTION A — UNIFORMS AND INSIGNIA

1. BACKGROUND

Although CPLA uniforms have remained basically the same since 1965, several new ones have been adopted. Sometime during August 1983 an honor guard unit composed of Army, Air Force, and Navy officers and enlisted personnel were reported wearing new uniforms similar to the People's Armed Police (PAP) uniforms, they all have braid, epauletts, and a crest. The traditional CPLA colors have been retained: olive-green for the Army; white and blue trousers for the Navy; and olive-green with blue trousers for the Air Force. The honor guard navy enlisted uniform resembles the traditional navy

enlisted uniform. Officer uniforms are still distinguished from those of the enlisted personnel by the number of pockets on the coat. Officer coats have four pockets; those of the enlisted personnel have only two.

Soon after the February 1979 Sino-Vietnamese conflict there were reports that the CPLA was about to introduce new uniforms and rank insignia, but only a few new uniforms have been seen and rank insignia has not yet been adopted. Sometime between 1976 and 1980, the Chinese Navy apparently discontinued the shore-based versions of naval uniforms, which consisted of summer and winter field dress uniforms for officers and parade and service uniforms for enlisted personnel.



CPLA Honor Guard on Parade.

2. GROUND FORCES UNIFORMS

a. Officers

Parade dress. Officers use the winter and summer service uniforms as parade uniforms by adding a brown leather belt and holster and white gloves. Sometimes a double-breasted, open-collar, overcoat with brown fur or piling is added to the winter parade uniform along with a brown fur or piling cap with folding earflaps. (Figure 15)

Service dress. Officers have a winter service dress made of woolen material and two summer service uniforms, one made of woolen material and the other cotton. These three uniforms are styled the same and consist of an olive-green coat with a soft, standing collar and two breast and two hip pockets. A pair of olive-green, cuffless trousers, a *jiefang* [Liberation] soft cap, and a pair of black shoes complete these uniforms. A red plastic, five-pointed star is worn on the cap and red tabs are worn on the collar. (Figure 15)

Field dress. Field dress uniforms for winter and summer are identical in style, made of olive-green, heavy cotton material for winter and light weight cotton material for summer. These uniforms consist of an olive-green coat, trousers, and rubber-soled, canvas shoes. The summer field uniform has reinforced, stitched patches on the coat elbows, trouser knees, and seat. The winter field dress uniform is worn with an inner lining of quilted cotton padding which gives it a bulky appearance. These uniforms become combat dress with the addition of pouches, belts, and other equipment. An olive-green, waist-length jacket, identical to the jacket worn by paratroopers, is sometimes worn as part of the field dress uniform by cadres and enlisted personnel. (Figure 15)

b. Female

Female officers and enlisted personnel wear the same summer and winter dress uniforms as the males. In 1974, female personnel also were authorized a dress uniform, olive-green in color, consisting of an open-collar coat and a below-the-knee skirt, a beret-type cap with red piping, olive-green socks, and single strap black shoes. The field uniforms for female personnel are identical to the male uniforms. Female personnel also have been seen wearing an olive-green coat, with two waist pockets and an open collar. The red collar tabs are apparently not worn with this uniform. (Figure 16)

c. Enlisted

Parade dress. Enlisted personnel, like officers, use the service dress uniform for parade dress. A brown leather belt with a pouch and white gloves are added to the service uniform when it is used as a parade dress uniform. In the winter, a double-breasted overcoat with a brown fur collar and a fur cap with earflaps are added. (Figure 15)

Service dress. Enlisted personnel have a summer and winter service dress uniform. This uniform consists of an olive-green coat, with two breast pockets and a standing collar, trousers, a *jiefang* cap, and black leather or olive-green canvas shoes. The winter service uniform is worn with cotton padded liners. A red star and collar tabs are worn with this uniform. (Figure 16)

Field dress. The field dress uniform for enlisted personnel is styled after the service uniform, but the material seems to be of a poorer quality. One field uniform has reinforced, stitched patches on the knees, elbows, and seat. (Figure 16)



Ground Forces Troops on Parade.

3. NAVY UNIFORMS

a. Officers

Parade dress. Naval officers have winter and summer parade dress uniforms. A brown leather belt and holster and white gloves are added to the winter service uniform for wear as a winter parade dress. The blue service cap or a *jiefang* cap is worn with this uniform. A blue overcoat with a brown fur collar, a brown fur cap, and the accessories listed above are used with the winter parade uniform. A black leather belt and a pair of white gloves are added to the all-white summer service uniform and is worn as a summer parade dress uniform. (Figure 17)

Service dress. Chinese naval officers apparently have one winter and two summer service uniforms. The winter service uniform consists of a dark-blue coat, trousers, and a service cap with a black visor and a dark-blue crown. This uniform is made of a medium-weight wool material. A *jiefang* cap is sometimes worn with this uniform. The two summer service uniforms are of the same style as the winter service uniform. One uniform consists of a white coat, trousers, and service cap; the other, a white

coat and service cap and dark-blue trousers. All of these uniforms are worn with black leather shoes or boots. (Figure 17)

Work dress. Three variations of a work uniform have been observed. One uniform consists of a waist-length, single-breasted jacket, with an open collar and two breast pockets, and trousers. These two items are dark-blue in color. A pair of black leather shoes and a service cap, with a white crown and a black visor, complete this uniform. The other work uniforms are alike except that the jacket is olive-green for one and khaki for the other. (Figure 17)

b. Female

Women have the same type of summer and winter uniforms, with the exception of the parade dress uniforms. In addition they wear a service dress uniform consisting of a white, open-collar coat with red collar tabs, a below-the-knee blue skirt, white bobby socks, black strap shoes or sandals, a buttoned, white blouse, and a dark-blue, beret-type cap with a red star and white piping. (Figure 17)



Naval Officers and Sailors.

c. Enlisted

Parade dress. Navy enlisted personnel have winter and summer parade dress uniforms. The winter parade dress uniform consists of a dark-blue coat, trousers, *jiefang cap*, and black leather shoes. A brown leather waist belt with an ammunition pouch and white gloves complete this uniform. A variation of this uniform consists of a double-breasted, blue overcoat with a brown fur collar and a brown fur cap, a brown waist belt with ammunition pouch, and white gloves. The summer parade dress uniform consists of the traditional white jumper with a red rectangular patch on each shoulder, a blue and white striped undershirt or a dickey, white trousers, and a large, round white-crown cap. A black leather belt and shoes and white gloves complete this uniform. (Figure 18)



Sailor Standing Guard

Service dress. Enlisted personnel have two basic service dress uniforms. The summer service uniform is identical to the summer parade dress without the black belt or white gloves. A variation of this uniform consists of blue trousers instead of white, and canvas, rubber-soled shoes. The winter service is identical to the summer parade uniform except that it is a dark-blue, woolen material. The other service uniform is identical to the winter parade uniform, without the brown belt and white gloves. (Figure 18)

Work uniforms. Two work dress uniforms have been identified. One uniform consists of a dark-blue, waist-length jacket with two breast pockets, an open collar, and single-breasted, banded-cuff sleeves, dark-blue trousers, black leather shoes, and a white sailor hat. The other work uniform, which looks like a variation of this uniform, consists of dark-blue trousers, a blue and white striped, long sleeve pullover shirt, a black belt, and canvas shoes. (Figure 18)

4. AIR FORCE UNIFORMS

a. Officers and Enlisted

Parade Dress. The Air Force parade uniform is believed to be similar to that of the ground forces; however, no positive identification has been made.

Service dress. The officer and enlisted personnel service uniform consist of an olive-green coat and *jiefang cap*, blue trousers, and black shoes. The only difference between these two uniforms is that the officer uniform is made of better quality material and the coat has four pockets, two chest and two waist. A variation of this uniform consists of a brown leather waist-length jacket instead of the olive-green coat. (Figure 19)

Work dress. Work uniforms for officers and enlisted personnel consist of blue trousers, an olive-green or blue waist-length jacket with an open collar and buttoned cuffs, a *jiefang cap*, and black shoes. Like the ground forces, the Air Force has cotton-padded trousers and coat liners for winter wear. (Figure 19)

b. Female

Female Air Force personnel have a service uniform similar to male personnel. They also wear a service uniform that consists of a tan or khaki-colored jacket, blue trousers, olive-green canvas shoes, and a beret-type cap. The other service uniform consists of an olive-green coat with an open collar, a below-the-knee blue skirt, a buttoned, white blouse, green bobby socks, one-strap black leather shoes, and a green beret-type cap with blue piping. (Figure 19)

c. Flight Uniforms

Several variations of flight uniforms are used. Male and female pilots wear a sheepskin lined, brown leather jacket, trousers, and calf-high black boots. The pilot uniform seen more often consists of a light-blue helmet, a green, waist-length jacket with an open collar and button cuffs, blue trousers, and calf-high, black leather boots. Another pilot uniform consists of a white helmet with a dark visor, a khaki, open-collar jacket, and blue trousers. (Figure 20)



Air Force Cadets.

5. FOUL WEATHER GEAR

All three services have their own distinctive foul weather gear. Ground forces personnel wear a poncho-like cape, made of heavy, rubberized material, which is olive-drab on one side and blue-black on the other. The poncho has a hood attached which can be pulled tight around the face by means of a draw string. (Figure 15) Air Force and Navy rain gear are similar. They are both dark-blue in color and consist of a jacket with a hood attached and trousers. The Navy also has a two piece rain suit made of heavy-weight, rubberized material. The trousers have a bib and suspenders attached to them. A molded hood covers the head and has an opening that fits snugly over the face and a bib that drapes over the chest and back.

6. SPECIAL UNIFORMS

Paratroopers. The paratroopers wear an Air Force uniform consisting of an olive-green coat, blue trousers, an olive-green steel helmet, and laced boots. During an August 1981 CPLA review, paratroopers wore what may be a new parade dress uniform. It consists of an olive-green steel helmet with a red star, a waist-length, olive-green jacket with two breast pockets, silver-colored metal discs on the shoulder straps, and an open collar. A white shirt with a standard collar is worn under the jacket. Blue trousers and calf-length, black leather boots complete the uniform. Red collar patches are worn on the jacket's collar. A blue, diamond-shaped patch with a white border, a white parachute, a red star in the center, and a pair of gold wings is worn on the right shoulder of this uniform. (Figure 19)

Camouflage. The camouflage uniform consists of green, rubber-soled, laced boots with a canvas top, trousers and a waist-length jacket with buttoned

cuffs and an open collar, all in a mottled pattern of shades of green and brown. This uniform has been seen worn with a camouflaged, billed, soft cap or a steel helmet. (Figure 16)

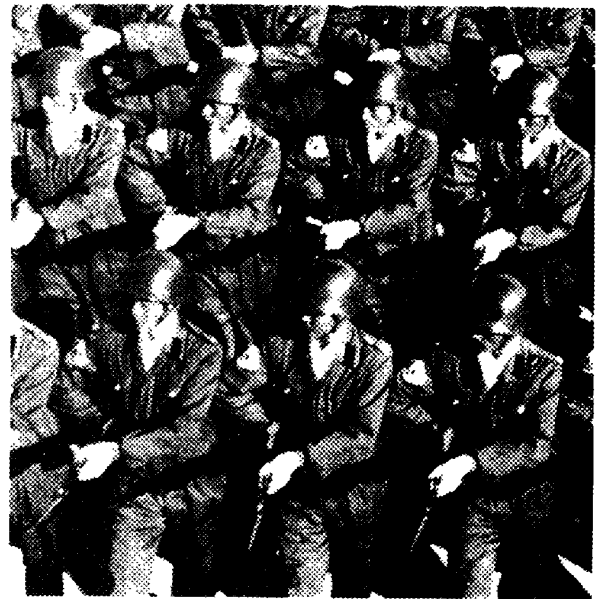

Air Force Paratroopers.

CBR Clothing. The CPLA has a one-piece suit, apparently made of a rubberized fabric, with a front opening from the neck to the crotch, a draw string around the ankles and face, gloves, and a face mask. (Figure 16)

Armored. Armored troopers wear a khaki, waist-length jacket, trousers tucked into calf-high, black leather boots and a black leather, ribbed helmet with built-in ear phones. This uniform is worn

over the ground force olive-green field uniform. (Figure 16)

People's Armed Police Force. According to a change approved by the party Central Committee and the State Council, the Chinese People's Armed Police Force were authorized new uniforms as of 1 August 1983.

The new uniforms consist of olive-green woolen-polyester jackets and trousers with a thin red stripe down the outer seam of the trouser legs. The four-pocket jacket has yellow and green braid on the sleeves and shoulder straps with yellow trim and PAP crests pinned on them. The service cap worn with this uniform has an olive-green crown, a band with alternate light and dark stripes, a black visor, and the PAP crest. Other People's Armed Police are authorized a summer uniform consisting of a green closed-collar coat, blue trousers, black shoes, and a service cap with a black visor and a green crown with red piping. Recently, border police have been seen wearing a diamond-shaped, red shoulder patch (probably a duty badge) with a gold-colored inscription in Chinese. (Figure 21) Traffic control police wear a white, closed-collar coat, blue trousers, black shoes, and a service cap with a blue visor and a white crown in summer and a completely blue uniform in winter. Female personnel wear a green, open-collar coat, a buttoned, white blouse, blue skirt, and a green, beret-type cap. The cap insignia for all personnel is the Tiananmen (Gate of Heavenly Peace) emblem. Red collar tabs are also worn. (Figure 21)

Militia. Militia members do not have an authorized uniform and have been identified wearing combinations of discarded CPLA uniforms, without the red star or red collar tabs, and sometimes matching civilian clothing. When in training, however, they all have ammunition pouches around a waist belt and carry small arms.

7. INSIGNIA

Collar Tabs. Red collar tabs are worn on most uniforms, except some Air Force uniforms such as work, service, and flight, and some female uniforms. Navy enlisted uniforms have a red rectangular patch on the shoulder.

Headgear Insignia. A plastic, red star, measuring about 3 centimeters in diameter, is displayed on all headgear worn by the CPLA forces, and the Tiananmen emblem is worn by police personnel. No headgear insignia is worn by the militia.

New Insignia. New uniforms first appeared in mid-1983 in units headquartered in the Beijing

Military Region. Their standardization and the addition of distinctive rank will probably spread to other regions and units in 1984 and 1985.

SECTION B — AWARDS AND DECORATIONS

1. BACKGROUND

Although such national awards as Orders and Medals of August 1st, Independence and Freedom, Liberation, and other decorations still exist in China, apparently none were awarded between 1965 and 1978.

Very limited information is available on medals and badges of the CPLA, but the following badges are believed to still be in use: Good-in-Five, Re-enlistment Badge, Peace Medal, and Model Soldier Badge.

Soon after the Sino-Vietnamese conflict in 1979, the national and some provincial governments issued medals in connection with this campaign.

2. MEDALS AND BADGES

Although some medals and badges have been identified, very little information is available. Available information on some of these medals appears below. The badges are illustrated in figure 22.

Order of Merit. (1st, 2d, and 3d classes illustrated). This medal is awarded in four classes and bestowed on individuals or units for exceptional combat service, devotion to duty, and bravery. The four classes are:

- Special Merit, the highest award granted for meritorious combat service or for bravery entailing death or the loss of a limb or major organ;
- 1st Class, awarded for meritorious service resulting in a serious loss to the enemy;
- 2d Class, awarded for meritorious service in which bravery beyond the call of duty was displayed; and
- 3d Class, awarded for meritorious service ranging from the conscientious performance of routine duties to the performance of unusual tasks under exceptional circumstances. (Figure 22)

Model Hero. Awarded in at least two classes, but eligibility criteria are not available. (Figure 22)

Self-Defense Counterattack/Border Defense. Issued after the Sino-Vietnamese border conflict in 1979. No additional information is available. (Figure 22)

Honor Guards. As part of the military professionalization program, the CPLA has adopted new honor guard uniforms and insignia some of which are shown in figures 23 and 24.

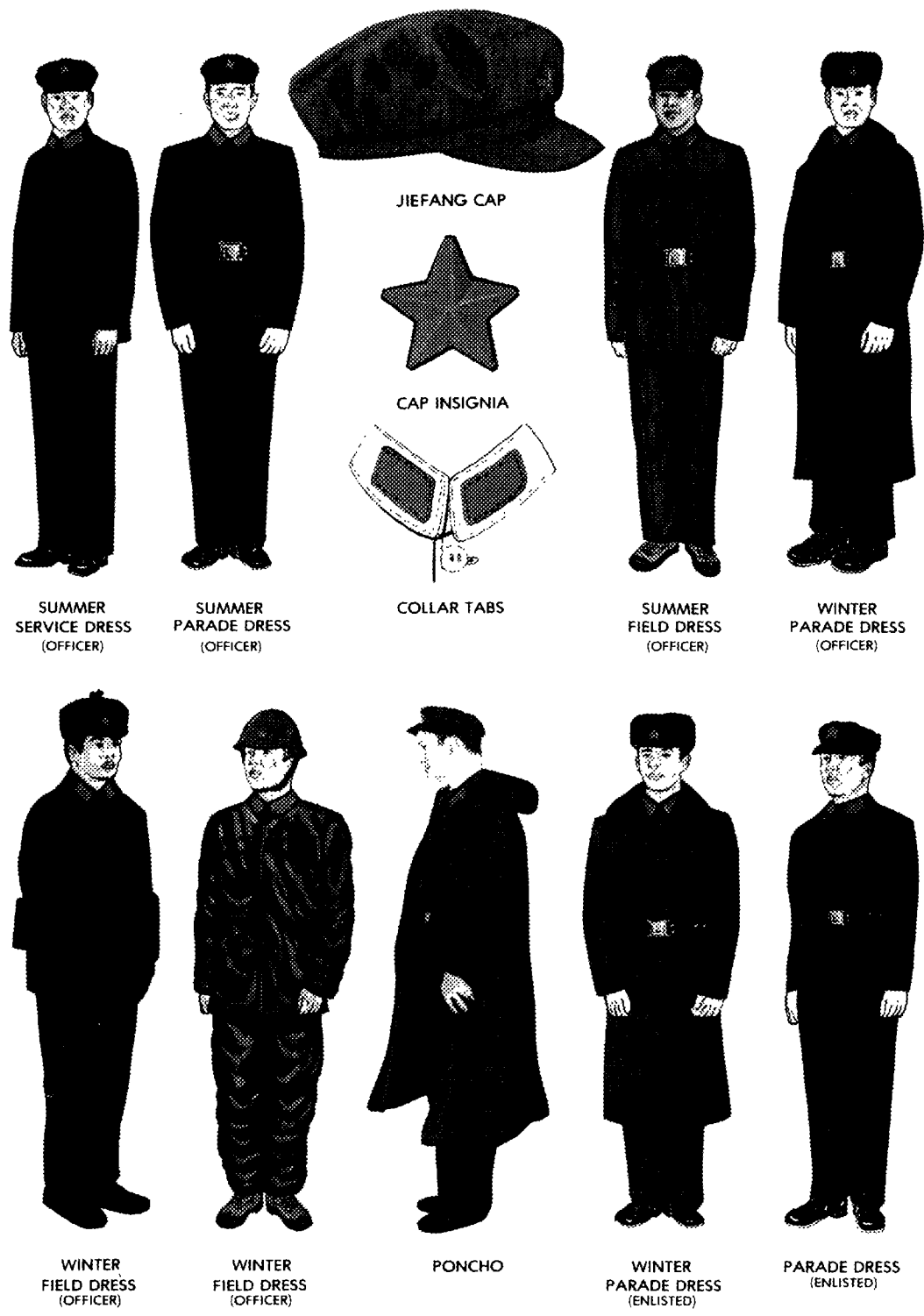

Figure 15. Army Personnel Uniforms and Insignia.



Figure 16. Army Personnel Uniforms and Insignia.

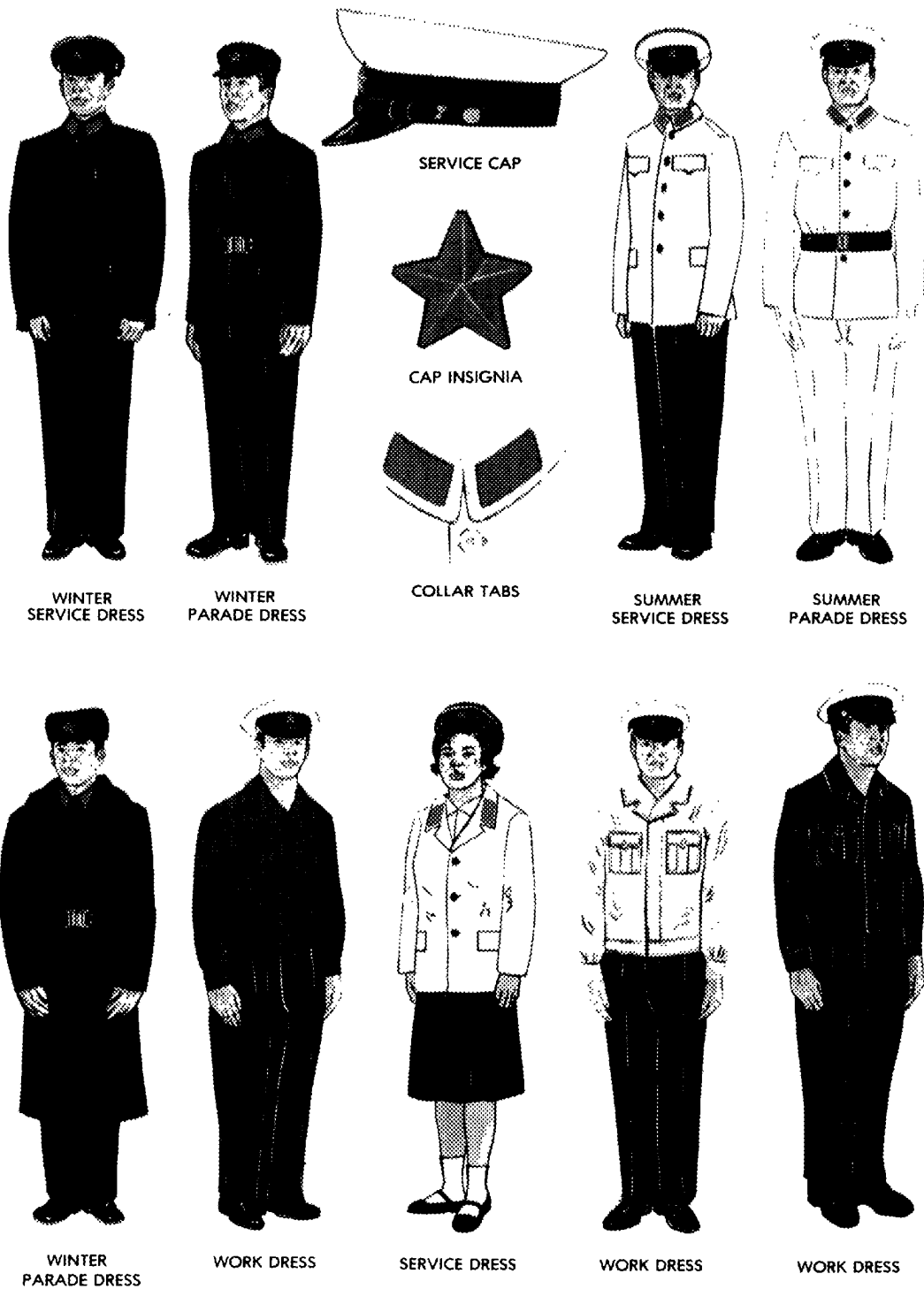
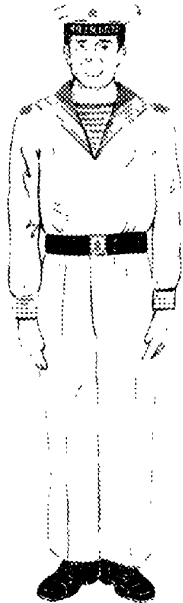

Figure 17. Naval Officers Uniforms and Insignia.



WINTER SERVICE DRESS



SUMMER PARADE DRESS

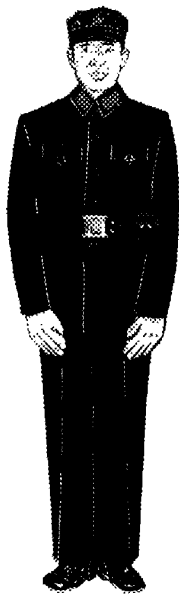

WINTER PARADE DRESS



WINTER SERVICE DRESS

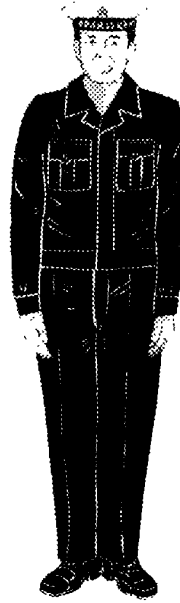

WORK DRESS



WINTER PARADE DRESS



SUMMER SERVICE DRESS



SEAMAN'S CAP



SHOULDER TAB SEAMAN



WORK DRESS



WORK DRESS

Figure 18. Naval Enlisted Uniforms and Insignia.

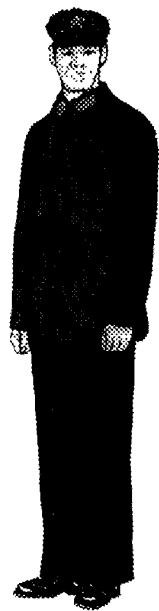

SERVICE DRESS
(OFFICER)



SUMMER
SERVICE DRESS

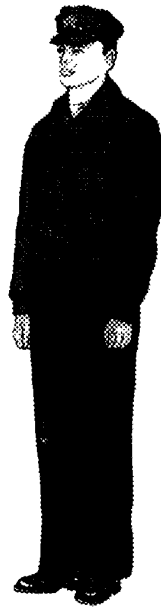

SUMMER
WORK DRESS



SUMMER
SERVICE DRESS

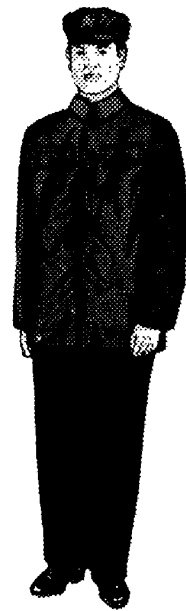

SERVICE DRESS
(ENLISTED)

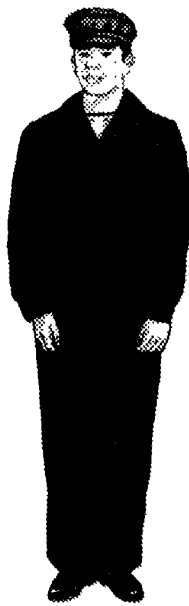

WORK DRESS



PARATROOPER
PARADE DRESS

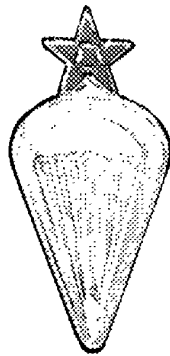

PARATROOPER
QUALIFICATION
BADGE



COLLAR TABS



CAP INSIGNIA



PARATROOPER
SHOULDER INSIGNIA



PARATROOPER
FIELD DRESS

Figure 19. Air Force Personnel Uniforms and Insignia.

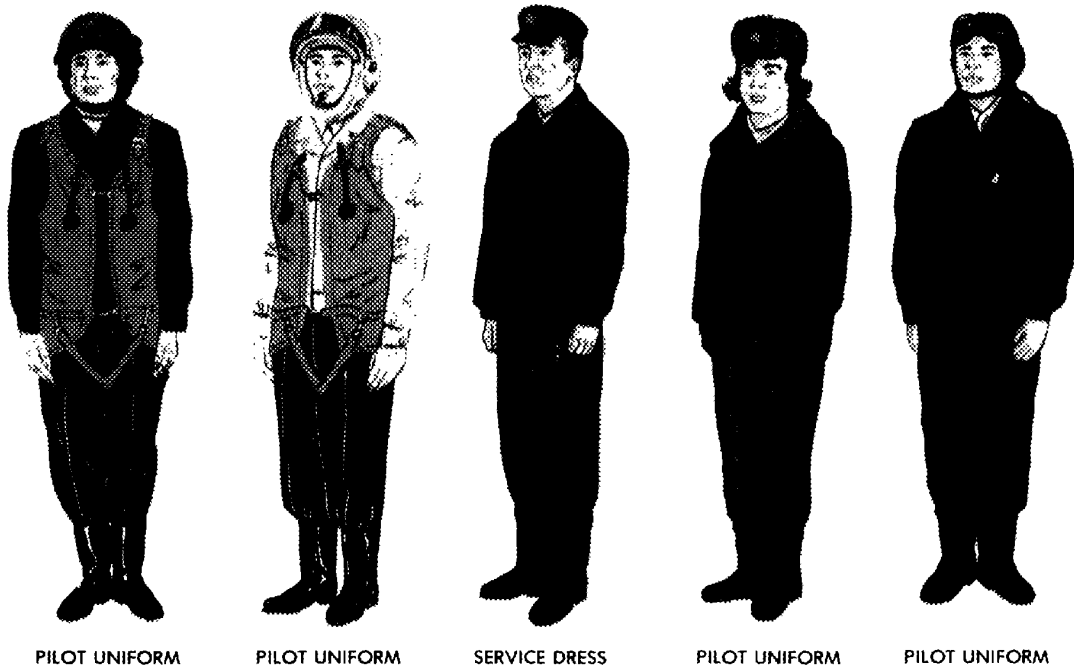

Figure 20. Air Force Personnel Uniforms.

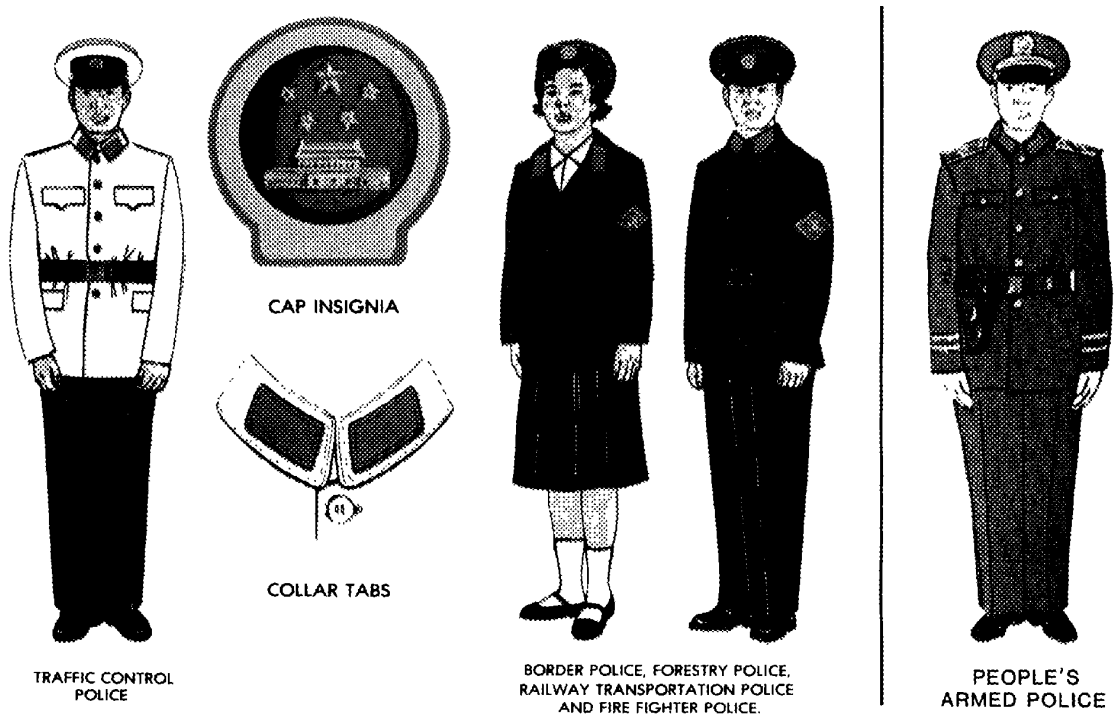
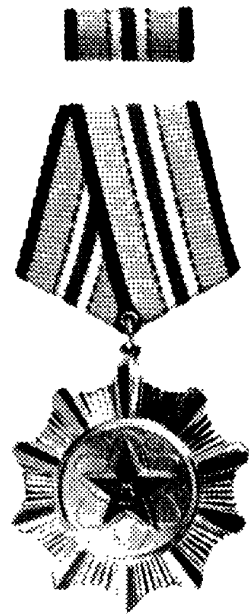
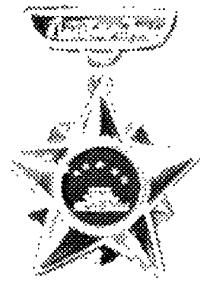

Figure 21. People's Armed Police Force Uniforms and Insignia.



MODEL HERO
FIRST CLASS



SELF-DEFENSE
COUNTERATTACK/
BORDER DEFENSE

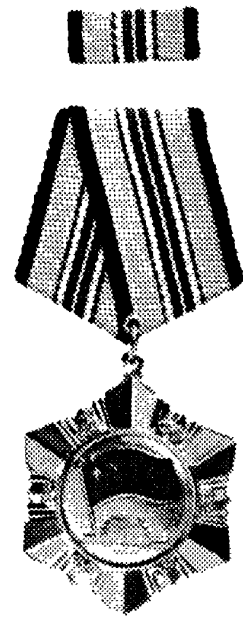

MODEL HERO
SECOND CLASS



FIRST CLASS
MERIT



SECOND CLASS
MERIT

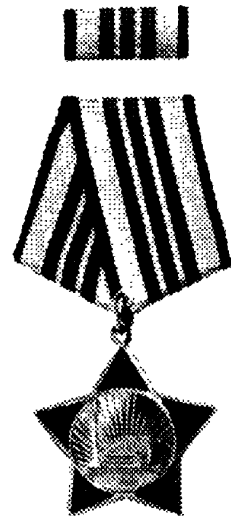

THIRD CLASS
MERIT

Figure 22. Chinese People's Liberation Army Awards.



ARMY ENLISTED PERSONNEL



AIRFORCE, NAVY, AND ARMY ENLISTED PERSONNEL



ARMY, NAVY, AND AIR FORCE ENLISTED PERSONNEL

Figure 23. New CPLA Honor Guard Uniforms.

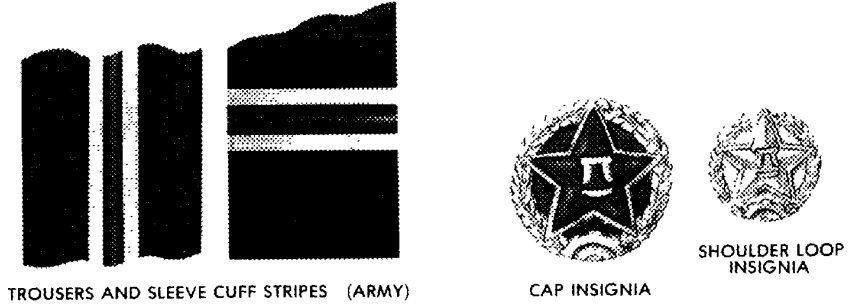
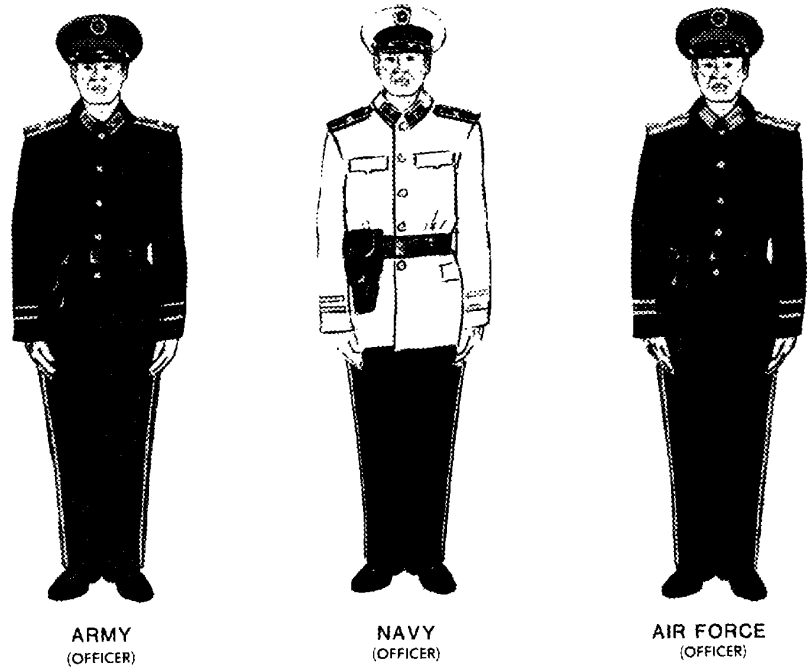

NOTE: ENLISTED PERSONNEL WEAR GOLD BUTTONS ON JACKET POCKETS AND AMMUNITION POUCH ON BELT INSTEAD OF HOLSTER.

SHOULDER LOOP AND COLLAR TAB INSIGNIA

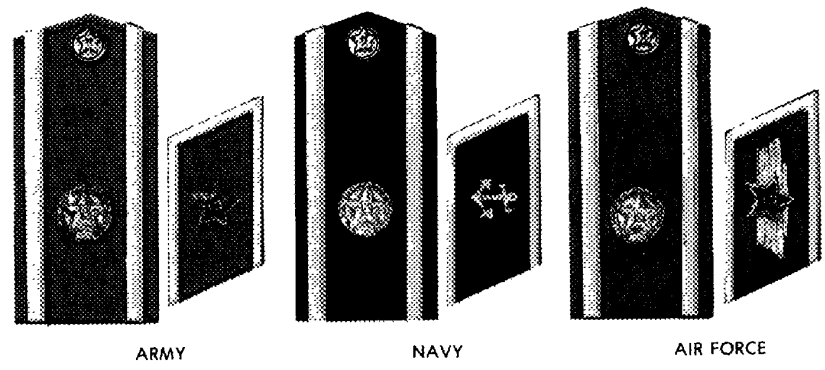
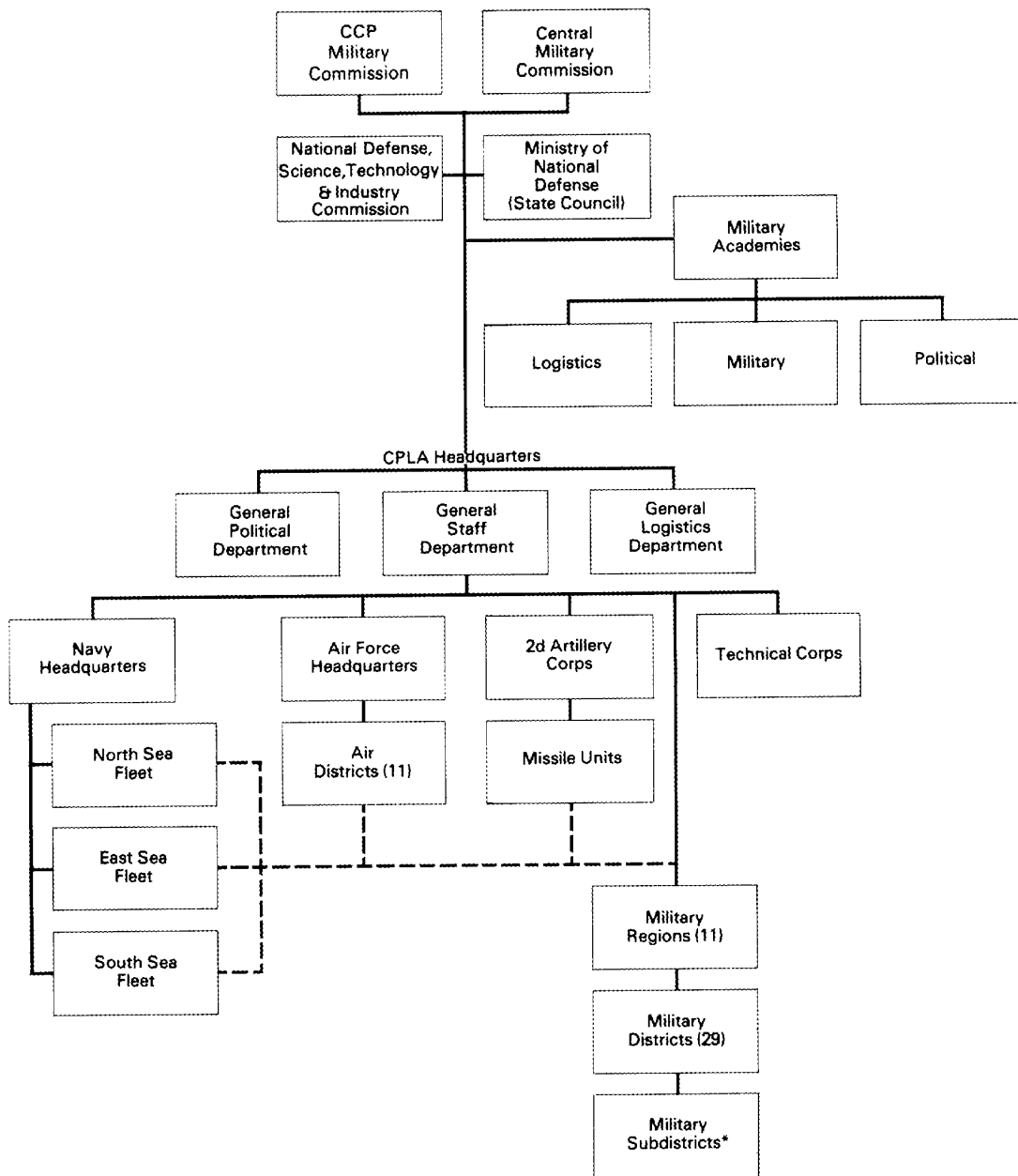

Figure 24. New CPLA Honor Guard Uniforms and Insignia.

Military Organization of China



———— Policy and Command
 - - - - Coordination

* Boundaries correspond to civil administrative districts.

Organization of an Army

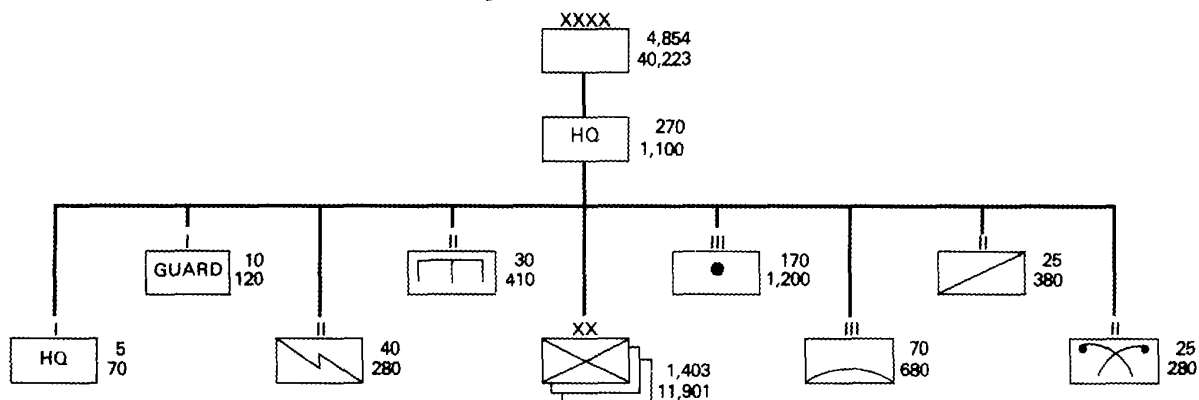

Table of Personnel and Major Equipment

Personnel/Equipment	Total Army	Hq Army	Hq Co	Recon Bn	Engr Bn	Sig Bn	CW Bn	Gd Co	AAA Regt	Arty Regt	Three Inf Div
Officers	4,854	270	5	25	30	40	25	10	70	170	4,209
Enlisted Personnel	40,223	1,100	70	380	410	280	280	120	680	1,200	35,703
Total Personnel	45,077	1,370	75	405	440	320	305	130	750	1,370	37,818
7.62mm LMG	1,087			30	30			10			1,017
7.62/12.7mm HMG	216										216
40mm Antitank Grenade Launcher (RPG)	1,558 +			X	X			10			1,548 +
57/75/82mm Recoilless Rifle	162										162
60/82/120/160mm Mortar	441										441
76/85/100mm Field Gun	54										54
122mm Howitzer	46									10	36
122/130mm Field Gun	10									10	
152mm Gun Howitzer	10									10	
130mm Rocket Launcher	72									18	54
14.5mm AAHMG	46								10		36
37/57mm AA Gun	79								25		54
Tank, Medium	240										240
APC	42										42
ARV	15										15
Truck, Cargo/Prime Mover	1,464	120	15	2	13	3	2		90	100	1,119
Artillery Tractor/Truck, Prime Mover	24									24	
CW Equipment, Various	X						X				X
Fiamethrower	81										81
Boat Inflatable, 4-10 man	X			X	X						X
Bridging Material	X				X						X
Radio Portable/Manpack	1,383 +	X	X	20	3	25	X	X	40	80	1,215
Radio, Vehicle Mounted	248 +	X	X	7	X	4	X	X	X	X	237

X = Amount of equipment not available.

Organization of an Infantry Division

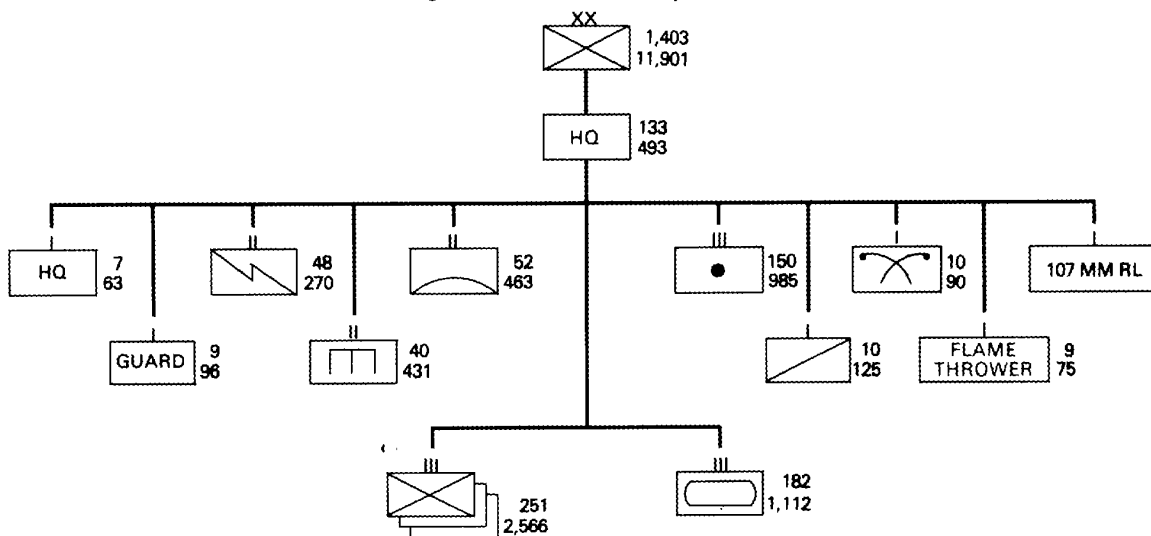

Table of Personnel and Major Equipment

Personnel/Equipment	Total Inf Div	Hq Inf Div	Hq Co	Recon Co	Engr Bn	Sig Bn	AAAW Bn	CW Co	FT Co	Gd Co	Tank Regt	Arty Regt	Three Inf Regts (Total)
Officers	1,403	133	7	10	40	48	52	10	9	9	182	150	753
Enlisted Personnel	11,901	493	63	125	491	270	463	90	75	96	1,112	985	7,698
Total Personnel	13,304	626	70	135	471	318	515	100	84	105	1,194	1,135	8,451
7.62mm LMG	339			9	27					6			297
7.62mm HMG	54												54
12.7mm HMG	18												18
40mm Antitank Grenade Launcher (RPG)	516+	48		X	X					X			468
57/75/82mm Recoilless Rifle	54												54
60mm Mortar	54												54
82mm Mortar	81												81
120/160mm Mortar	12											12	
85mm Field Gun	18											18	
122mm Howitzer	12												
130mm Rocket Launcher	18												
14.5mm AAHMGM	12						12						
37/57mm AA Gun	18						18						
Tank, Medium	80										80		
APC	14										14		
ARV	5										5		
Truck, Cargo/Prime Mover*	373+	67	12		15+	3	60				29	97	90
Motorcycle w/Sidecar	44+			9	4	X		5			12	5	9
CW Equipment, Various	X				X			X			X		X
Flamethrower	27								27				
Radio, Manpack/Portable	405			8	5	21	31				18	70	252

X = Amount of equipment not available.

* Includes 6 ambulances.

Organization of an Infantry Regiment, Infantry Division

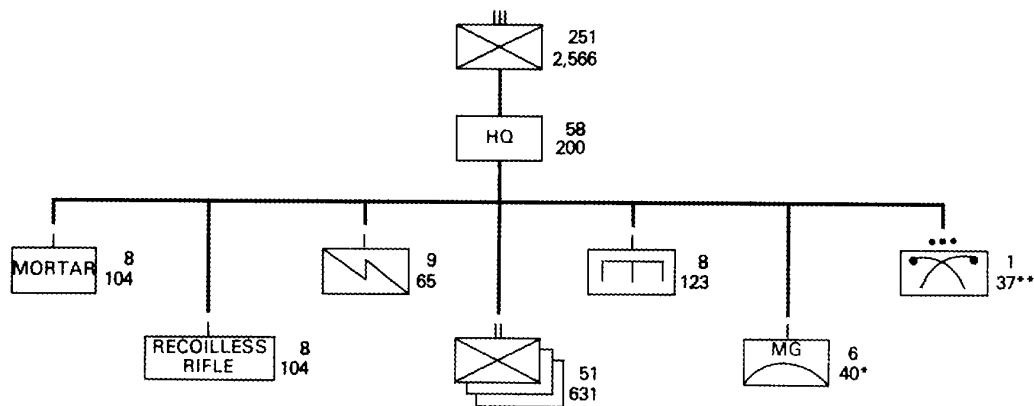

* Some regiments may have an AAMG platoon.
 ** Not organic to every regiment.

Table of Personnel and Major Equipment

Personnel/Equipment	HQ Infantry Regiment						Mort Co	Rcl Rifle Co	Sig Co	Engr Co	AAMG Co	CW Plt	Three Inf Bns (Total)
	Total Inf Regt	Ops Ofc	Polit Ofc	Log HQ & Staff	Tpt Co	Med Co							
Officers	251	16	14	9	9	10	8	8	9	8	6	1	153
Enlisted Personnel	2,566	26	15	35	75	49	104	104	65	123	40	37	1,893
Total Personnel	2,817	42	29	44	84	59	112	112	74	131	46	38	2,046
7.62mm Pistol	235	16	14	9	9		8	8	9	8	6	1	147
7.62mm Assault Rifle	817						48	30	16	46	10	4	663
7.62mm Carbine	1,398						55	73	48	76	30	33	1,083
7.62mm Assault Rifle/Carbine	151	26	15	35	75					9			90
7.62mm LMG	99												18
7.62mm HMG	18										6		
12.7mm HMG	6												
40mm Antitank Grenade Launcher (RPG)	156				6		6	6	6	12	6	6	108
60mm Mortar	18												18
82mm Mortar	27						9						18
57mm Recoilless Rifle	9												9
75/82mm Recoilless Rifle	9							9					
Mine, Antitank	X									X			
Radio, Manpack	84						1	1	7	5	4		66
CW Equipment, Various	X												X
Truck, Cargo	30				30								
Motorcycle w/Sidocar	3				3								

X = Amount of equipment not available.

Organization of an Infantry Battalion

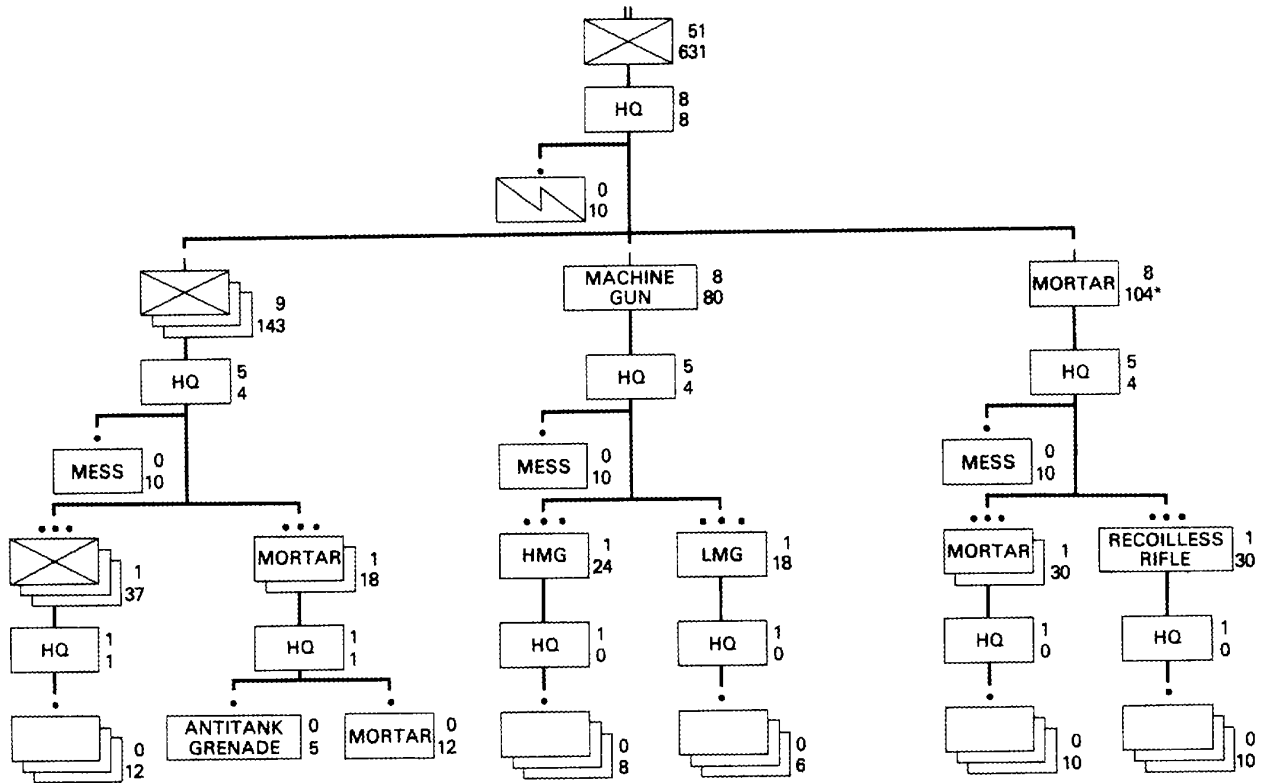

* Some battalions do not have these companies but do have a machinegun and a mortar company made up from elements of them.

Table of Personnel and Major Equipment

Personnel/Equipment	Total Infantry Battalion	Hq and Signal Squad	Three Rifle Companies (Total)	Machine-gun Company	Mortar Company
Officers	51	8	27	8	8
Enlisted Personnel	631	18	429	80	104
Total Personnel	682	26	456	18	112
7.62mm Pistol	49	6	27	8	8
7.62mm Assault Rifle	221	11	147	21	42
7.62mm Carbine	361	5	246	49	61
7.62mm LMG	30		27	3	
7.62mm HMG	6			6	
60mm Mortar	6		6		
82mm Mortar	6				6
40mm Antitank Grenade Launcher (RPG)	36	3	27	3	3
57/75 Recoilless Rifle	3				3
Radio, Manpack	22	2	18	1	1
Switchboard	X	X			
Field Telephone	X		X	X	X
Horses/Mules	14+	2	X	X	12

X = Amount of equipment not available.

Organization of an Airborne Division

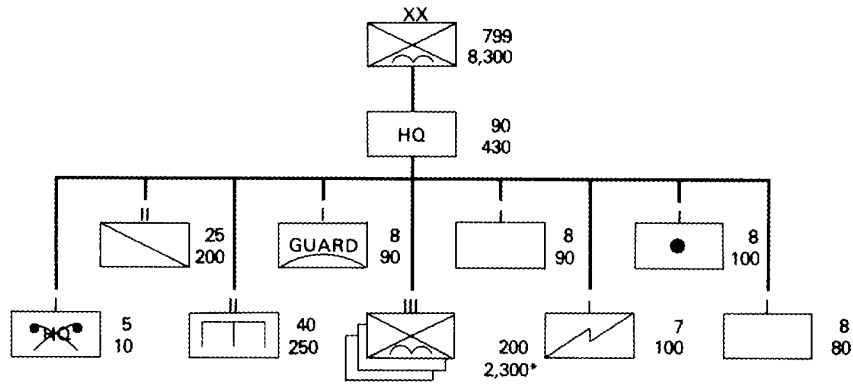

* Organization of airborne regiments and battalions is similar to that of infantry regiments and battalions but minus the heavy weapons.

Table of Personnel and Major Equipment

Personnel/Equipment	Total Abn Div	Div Hq	Hq Co	Gd Co	AA Co	Eng Co	Recon Co	CW Co	Sig Bn	Arty Bn	Three Abn Regts (Total)
Officers	799	90	5	8	8	7	8	8	40	25	600
Enlisted Personnel	8,300	430	60	90	90	100	100	80	250	200	6,000
Total Personnel	9,099	520	65	98	98	107	108	88	290	225	7,500
7.62mm LMG	294			5		7	7				240
7.62mm HMG	75										75
14.5mm AAMG	15				3						12
60mm Mortar	45										45
82mm Mortar	45										45
120mm Mortar	9										9
40mm AT Grenade Launcher (RPG)	516 +										516 +
82mm Recoilless Rifle	75										75
37mm AA Gun	5				5						5
Gas Mask/Protective Clothing	189							90			99
Radio, Manpack	307									7	300
Radio, Portable/Manpack	28				8		2		18		28
Radio, Vehicle Mounted	3								3		3
Truck, Cargo	105	25		5							75
Truck, Utility	2								2		2
Parachute, Main	8,511	110	32	98	80	90	90	70	216	225	7,500
Parachute, Reserve	8,511	110	32	98	80	90	90	70	216	225	7,500

Organization of a Tank Division

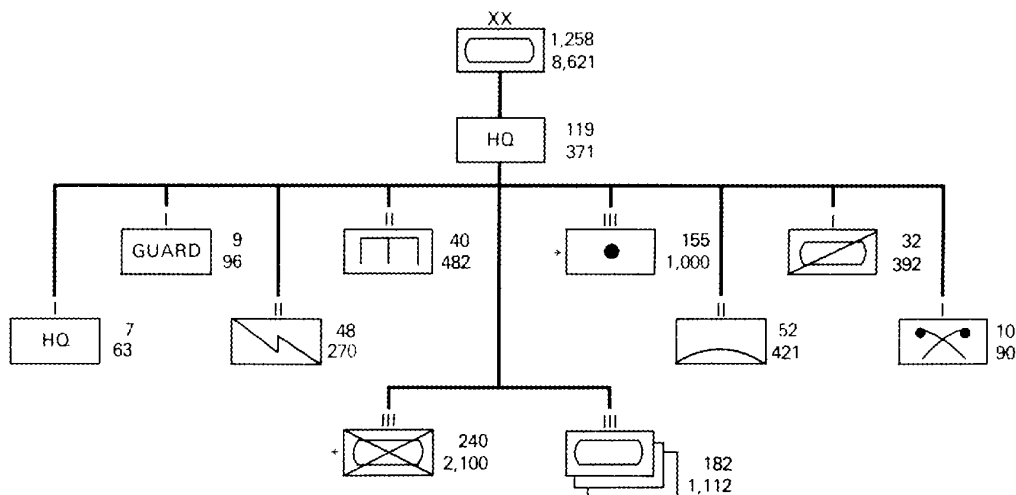

* Not all tank divisions have mechanized infantry and artillery regiments.

Table of Personnel and Major Equipment

Personnel/Equipment	Total Tank Div	Hq Tank Div	Hq Co	Recon Bn	Sig Bn	Engr Bn	AAA Bn	Gd Co	CW Co	* Arty Regt	* Mech Inf Regt	Three Tank Regts (Total)
Officers	1,258	119	7	32	48	40	52	9	10	155	240	546
Enlisted Personnel	8,621	371	63	392	270	482	421	96	90	1,000	2,100	3,336
Total Personnel	9,879	490	70	424	318	522	473	105	100	1,155	2,340	3,882
7 62mm LMG	125			10		30		5			80	
12.7 HMG	5										5	
40mm Antitank Grenade Launcher (RPG)	156*			X		X		X			156	
57/75mm Recoilless Rifle	8										8	
75/82mm Recoilless Rifle	9										9	
60mm Mortar	15										15	
82mm Mortar	25										25	
120/160mm Mortar	10									10		
76/85/100mm Field Gun	20	X								20		
122mm Howitzer	12									12		
14.5mm AAHMG	12						12					
37/57mm AA Gun	18						18					
Tank, Medium	240	1										240
Armored Recovery Vehicle	20			5								15
Armored Personnel Carrier	139			12							85	
Light Tank	12			12								42
Truck, Cargo*	535	50	10		5	10	50			90	80	240
Truck, ¼-½ ton	72	5	10		1	1				5	20	30
Wrecker	8	1								2	5	
Motorcycle w/Sidecar	58					3			3	3	19	30
CW Equipment, Various	X					X			X	X	X	X
CW Decontamination Vehicle	5								2			3
Radio, Manpack/Portable	335			10	20	5	30			60	105	105
Radio, Vehicle Mounted	628	6		6	6						100	510

X = Amount of equipment not available

* Includes 7 ambulances and 3 radio trucks.

Organization of a Tank Regiment

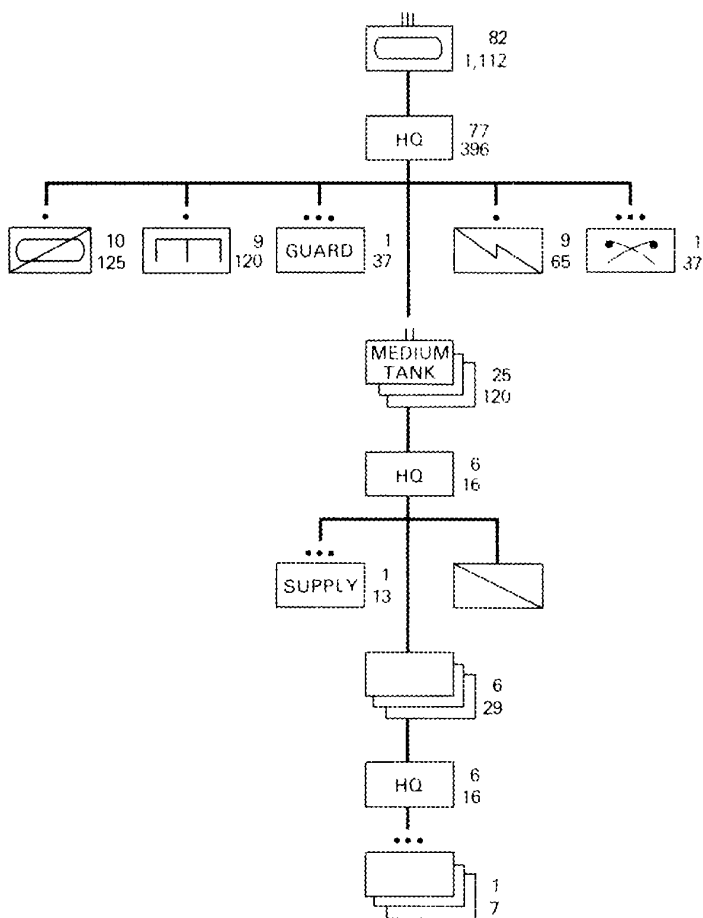

Table of Personnel and Major Equipment

Personnel/Equipment	Total Tank Regt	Headquarters, Tank Regiment							Recon Co	Engr Co	Gd Plt	Sig Co	CW Plt	Three Med Tk Bns (Total)
		Ops Ofc	Pol Ofc	Log Hq & Staff	Mnt Co	Trans Co	Med Co							
Officers	82	14	18	17	10	9	9	10	9	1	9	1	75	
Enlisted Personnel	1,112	19	24	30	142	135	18	125	120	40	65	37	360	
Total Personnel	1,194	33	42	47	152	144	27	135	129	41	74	38	435	
Tank, Medium	80	2											78	
Armored Personnel Carrier	14	2						9					3	
Armored Recovery Vehicle	5				5									
Truck, Cargo	80					59							21	
Truck, ¼-½ ton	10	1				6				2	1			
Motorcycle w/Sidecar	10							10						
CW Equipment, Various	X											X		
CW Decontamination Vehicle	1											1		
Radio, Manpack/Portable	33							4	2		4	2	21	
Radio, Vehicle Mounted	152	2				3		3			3		141	

X = Amount of equipment not available

Organization of a Mechanized Infantry Regiment, Tank Division

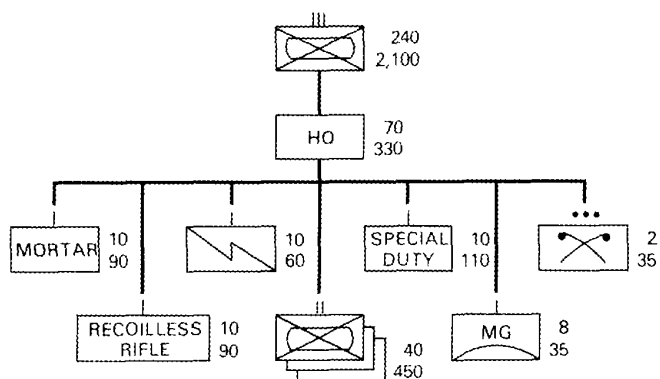

Table of Personnel and Major Equipment

Personnel/Equipment	Total Mech Inf Regt	Hq Mech Infantry Regiment					Mort Co	Rcl Rifle Co	Sig Co	SD Co	AAA Co	CW Plt	Three Mech Inf Bns (Total)
		Ops Ofc	Pol Ofc	RSvc Hq & Staff	Trans Co	Med Co							
Officers	240	20	15	10	15	10	10	10	10	8	2	120	
Enlisted Personnel	2,100	30	10	30	220	40	90	90	110	35	35	1,350	
Total Personnel	2,340	50	25	40	235	50	100	100	120	43	37	1,470	
7.62mm LMG	80								8			72	
12.7mm HMG	5									5			
40mm Antitank Grenade Launcher (RPG)	156				6		6	6	12	6	6	108	
60mm Mortar	15						4					15	
82mm Mortar	25											21	
57/75mm Recoilless Rifle	8											8	
75/82mm Recoilless Rifle	9							9					
CW Equipment, Various	X										X		
Radio, Manpack	105						1	1	7	4		84	
Radio, Vehicle Mounted	100				85							15	
Truck, Cargo	80				80								
Truck, ¼ - ½ ton	20				8								
Armored Personnel Carrier	85				85							12	
Wrecker	5				5								
Motorcycle w/ Sidecar	19				5			10	4				
Ambulance	1					1							

X = Amount of equipment not available

Organization of an Artillery Division

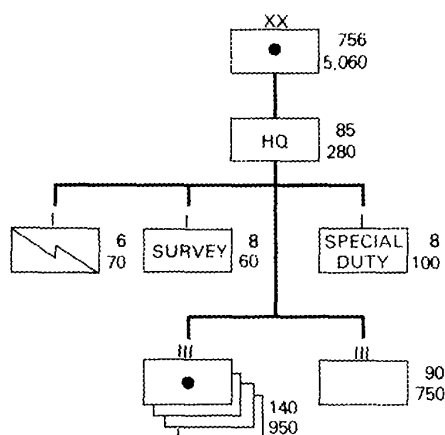

Table of Personnel and Major Equipment

Personnel/Equipment	Total Arty Div	Hq Arty Div	Sig Co	Survey Co	SD Co	Four Arty Regts (Total)	RL Regt
Officers	756	85	6	8	8	560	90
Enlisted Personnel	5,060	280	70	60	100	3,800	750
Total Personnel	5,816	365	76	68	108	4,360	840
122/130mm Gun, 122mm Corps Gun, 122/152mm How, 152mm Gun How	136					136	
130mm RL	36						36
Truck, Radio	2		2				
Truck, Cargo/Prime Mover	474	50	2		2	360	60
Truck, ¼-½ ton	35	2	2	1	10	16	4
Wrecker	7	1				4	2
Ambulance	7	2				4	1
Motorcycle w/Sidecar	27		8			16	3
CW Equipment, Various	X				X		
Radio, Portable/Manpack	318		6	2		260	50
Radio, Vehicle Mounted	4		4				
Switchboard	X		X			X	X
Field Telephone	X		X	X		X	X
Teletype	X		X				

X = Amount of equipment not available.

Organization of an Antiaircraft Artillery Division

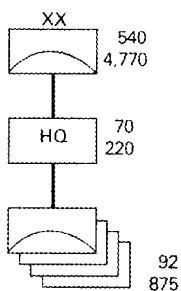

Table of Personnel and Major Equipment

Personnel/Equipment	Total AAA Div	Hq AAA Div	Comd Co	Special Duty Co	Five Regts (Total)
Officers	540	70	5	5	460
Enlisted Personnel	4,770	220	75	100	4,375
Total Personnel	5,310	290	80	105	4,835
14.5mm AAMG	53				90
57mm AA Gun	120				120
37mm AA Gun	90				90
Radar, AA Early Warning	5				5
Radar, AA Fire Control	15				15
Director, AA Fire Control	15				15
Range Finder, Stereoscopic	15				15
Generator	30				30
Truck, Radio	1		1		
Truck, Cargo/Prime Mover	702	30	1	1	670
Truck, ¼ - ½ ton	25	1	1	8	15
Wrecker	6	1			5
Ambulance	7	2			5
Motorcycle w/Sidecar	6		6		
CW Equipment, Various	X			X	
Radio, Portable/Manpack	309		4		305
Radio, Vehicle Mounted	1		1		
Switchboard	X		X		
Field Telephone	X		X		
Teletype	X		X		

X = Amount of equipment not available.

Organization of an Engineer Regiment

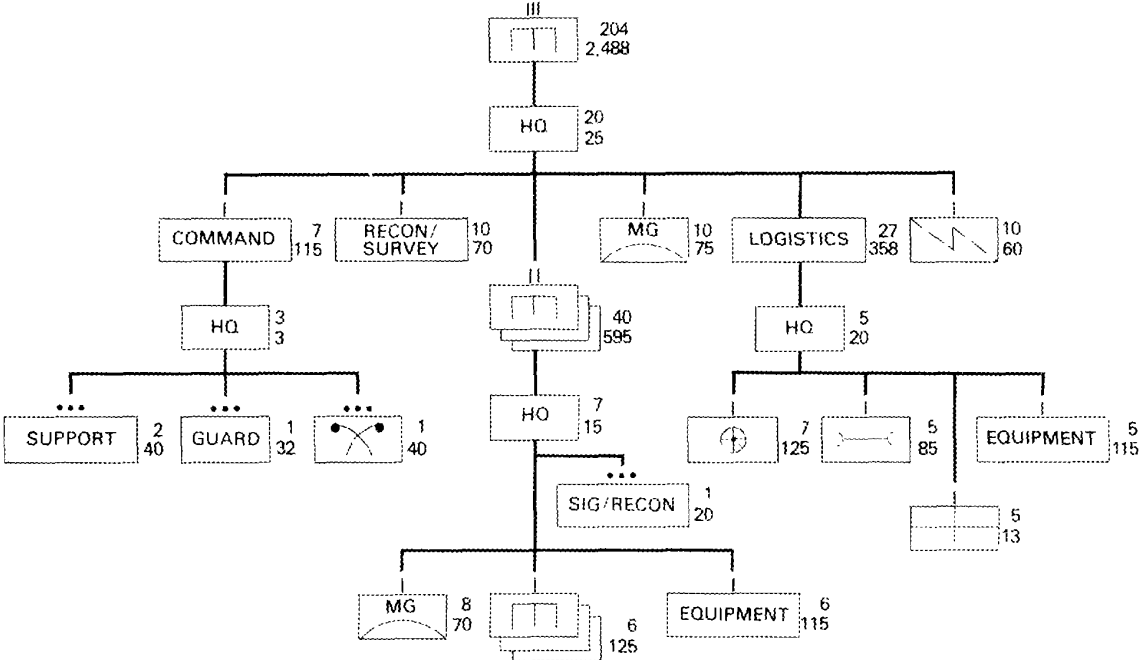

Table of Personnel and Major Equipment

Personnel/Equipment	Total Engr Regt	Headquarters Engineer Regiment										Three Engr Bns (Total)
		Hq	Comd Co	Recon/Survey Co	MG Co	Sig Co	Logistics					
							Log Hq	MT Co	Equip Co	Maint Co	Med Unit	
Officers	204	20	7	10	10	10	5	7	5	5	5	120
Enlisted Personnel	2,488	25	115	70	75	60	20	125	115	85	13	1,785
Total Personnel	2,692	45	122	80	85	70	25	132	120	90	18	1,905
12.7mm HMG/14.5mm AAMG	54				15							39
40mm AT Grenade Launcher (RPG)	48		3	3	3	3						36
Truck, Cargo	85				6			48	7			24
Truck, Dump	9							9				
Truck, ¼-½ ton	14		1	1	1	3	1	2	1	1		3
Amphibious Armored Vehicle	8			3					2			3
Ambulance	1											
Bulldozer	3								3			
Road Grader	12								3			9
Rock Crusher	6								6			
Tractor	6								6			
Steam Roller	6								6			
Truck, Crane	9								6			3
Repair Van	6							6				
Outboard Motor Boat	8							2				6
Cement Mixer	12								9			3
Air Compressor	10								4			6
Generator	10										4	6
Truck, Radio	8		1			3	1					3
Radio, Vehicle Mounted	15		1	3	1	3		2	1	1		3
Radio, Portable/Manpack	49		1	3	4	6	1	3	3	3		24

Organization of a Pontoon Bridge Regiment

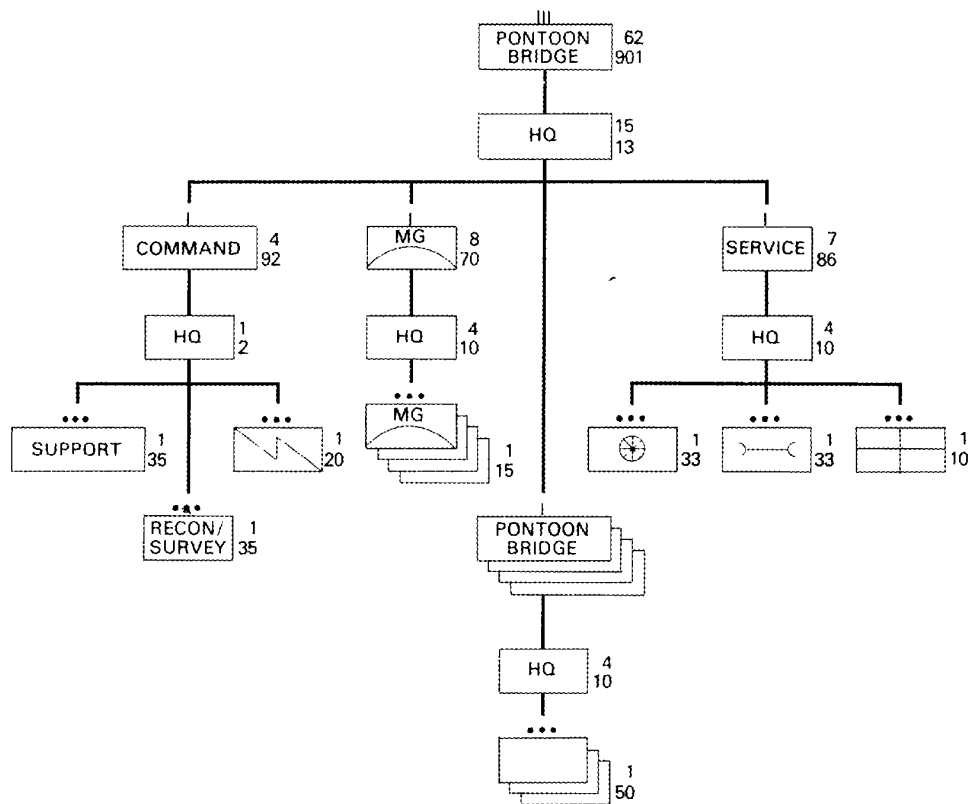
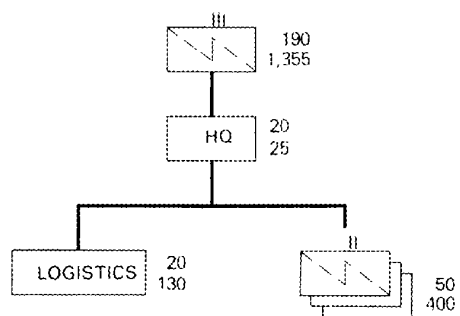

Table of Personnel and Major Equipment

Personnel/Equipment	Total Pont Br Regt	Hq Pontoon Bridge Regiment				Four Pont Br Companies
		Head-quarters	Command Company	AAMG Company	Service Company	
Officers	62	15	4	8	7	28
Enlisted Personnel	901	13	92	70	86	640
Total Personnel	963	28	96	78	93	668
7.62mm Pistol	61	15	5	8	5	28
7.62mm Assault Rifle	765	13	45	65	30	625
7.62mm Carbine	118	13	35		35	35
12.7mm HMG	10			10		
40mm Antitank Grenade Launcher (RPG)	21		3	4	2	12
Pontoon	96/72*					96/72*
Truck, Cargo	155			5	30	120
Truck, Crane	3					3
Armored Reconnaissance Vehicle	6		3			3
Motorcycle	2		2			
Bulldozer	1				1	
Ambulance	1				1	
Power Boat	13					13
Radio, Portable/Manpack	17		5	4	2	6
Truck, Radio	1		1			

* 48 bow, 48 center sections/36 bow, 36 center sections.

Organization of a Signal Regiment

NOTE: The signal regiment provides communications for military region and military district headquarters. The strength, composition and equipment will vary according to the needs of the area the regiment serves

Organization of a Motor Transport Regiment

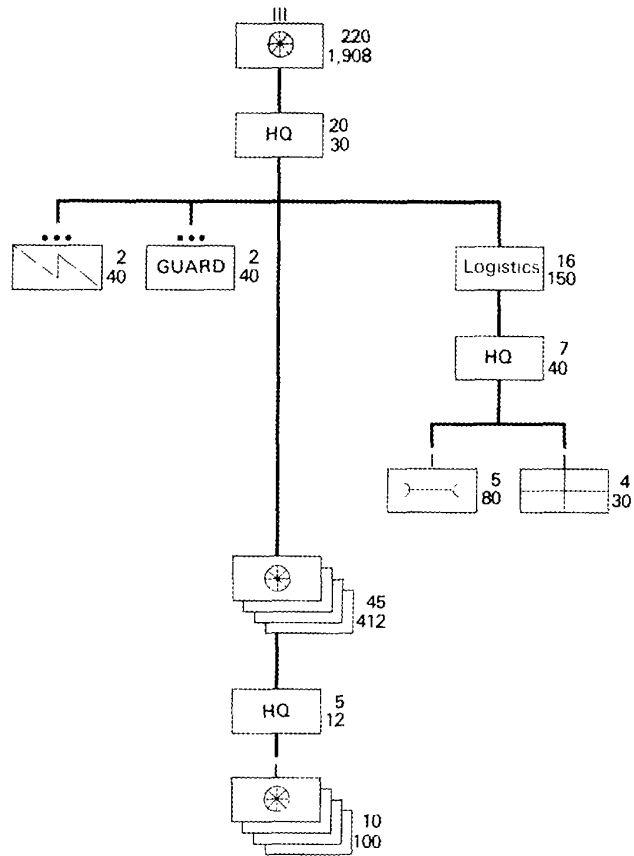

Table of Personnel and Major Equipment

Personnel/Equipment	Total MT Regt	Hq Regt	Sig Plt	Guard Plt	Log	Four MT Bns (Total)
Officers	220	20	2	2	16	180
Enlisted Personnel	1,908	30	40	40	150	1,648
Total Personnel	2,128	50	42	42	166	1,828
7.62mm Pistol	172	18	1	1	12	140
7.62mm Rifle/Carbine	1,800	20	30	30	120	1,600
7.62mm LMG	1			1		
Truck, Cargo	702				2	700
Truck, ¼-½ ton	18				2	16
Wrecker	14				2	12
Ambulance	1				1	
Motorcycle	34		2			32
Radio, Portable/Manpack	25		4	1		20
Switchboard	6		2			4
Field Telephones	56		12			44

Organization of a Border Defense Division

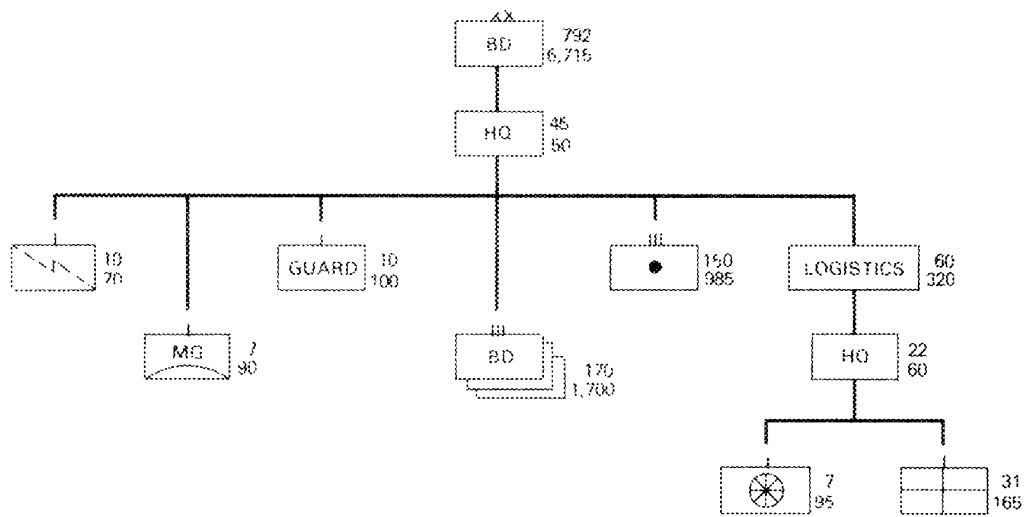
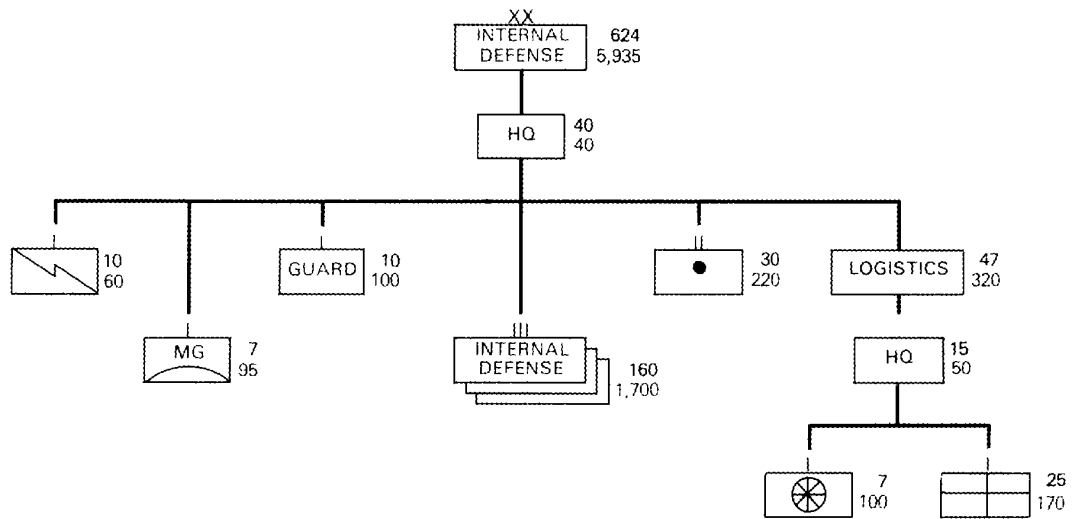

Table of Personnel and Major Equipment

Personnel/Equipment	Total BD Div	Div Hq	Sig Co	AAMG Co	Guard Co	Arty Regt	Log	Three BD Regts (Total)
Officers	792	45	10	7	10	150	60	510
Enlisted Personnel	6,715	50	70	96	100	985	320	5,100
Total Personnel	7,507	95	80	97	110	1,135	380	5,610
7.62mm LMG	244				4			240
7.62mm HMG	24							24
12.7mm HMG	12			6				6
57/75mm Recoilless Rifle	6							6
60mm Mortar	54							54
82mm Mortar	6							6
85mm Gun	18					18		
122mm How	12					12		
120/160mm Mortar	12					12		
107/130mm Rocket Launcher	18					18		
Truck, Cargo	110					13	97	15
Truck, 1/4 - 1/2 ton	4						1	3
Ambulance	4						1	3
Motorcycle w/Sidecar	3		3					
Radio, Portable/Manpack	236		3			18		210
Switchboard	47		5			3		39
Field Telephone	260		20			12		228
Horses/Mules	120 +					X		120
Dogs	155				5			150

X = Amount of equipment not available.

Organization of an Internal Defense Division*



* These units are in the process of being transferred to the People's Armed Police under the Public Security Bureaus.

Table of Personnel and Major Equipment

Personnel/Equipment	Total Inf Def Div	Div Hq	Sig Co	AAMG Co	Guard Co	Arty Bn	Log	Three Inf Def Regts (Total)
Officers	624	40	10	7	10	30	47	480
Enlisted Personnel	5,935	40	60	95	100	220	320	5,100
Total Personnel	6,559	80	70	102	110	250	367	5,580
7.62mm LMG	245				5			240
7 62mm HMG	24							24
12 7mm HMG	12			6				6
57/75mm Recoilless Rifle	6							6
60mm Mortar	48							48
82mm Mortar	6							6
76mm How/Gun, 85mm Gun, 122mm How	8					8		
Truck, Cargo	79					14	50	15
Truck, ¼-½ ton	6						3	3
Ambulance	4						1	3
Motorcycle w/ Sidecar	3		3					
Radio, Portable/Manpack	125		8			18		99
Switchboard	26		5			3		18
Field Telephone	228		21			12		195
Horses/Mules	150 +					X		150
Dogs	104				5			99

X - Amount of equipment not available

Organization of a Garrison Division*

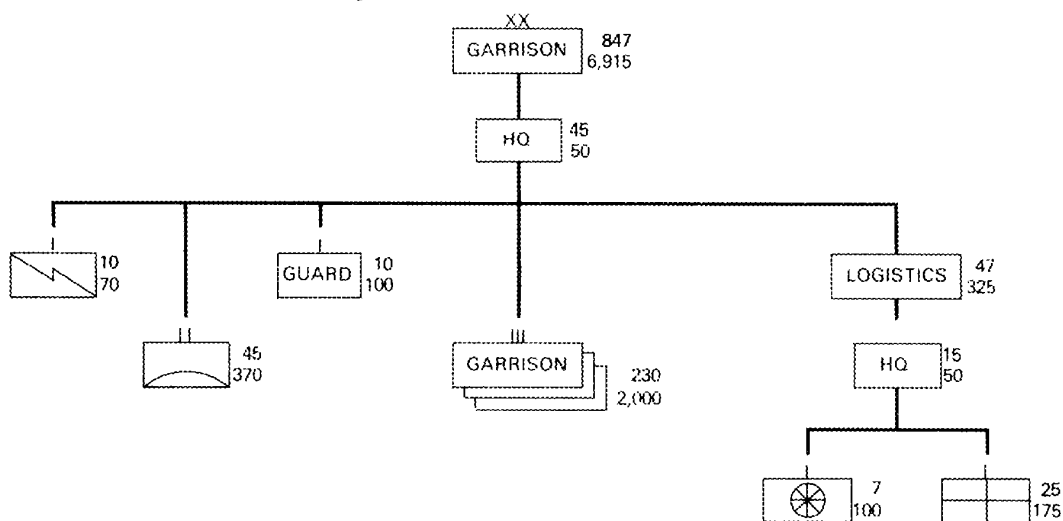

* Some divisions have organic artillery and tank regiments.

Table of Personnel and Major Equipment

Personnel/Equipment	Total Gar Div	Hq Div	Sig Co	AAA Bn	Gd Co	Log	Three Gar Regts (Total)
Officers	847	45	10	45	10	47	690
Enlisted Personnel	6,915	50	70	370	100	325	6,000
Total Personnel	7,762	99	80	415	110	372	6,690
7.62mm LMG	104				5		99
7.62mm HMG	48						48
12.7mm HMG	15						15
40mm Antitank Grenade Launcher (RPG)	44				2		42
57/75mm Recoilless Rifle	48						48
60mm Mortar	15						15
82mm Mortar	24						24
57mm AT Gun	24						24
85/122/130mm Gun/152mm Gun How	66						66
14.5mm AAMG	9			9			
37mm AA Gun	15			15			
Truck, Cargo/Prime Mover	89			5		39	45
Truck, ¼ - ½ ton	9					3	6
Ambulance	6					3	3
Motorcycle w/ Sidecar	12		3				9
Boat, Transport/Patrol	38					5	33
Radio, Portable/Manpack	132		8	4			120
Field Telephone	238		21	28			189
Horses/Mules	150						150
Dogs	44				5		39

Probable Militia Organization

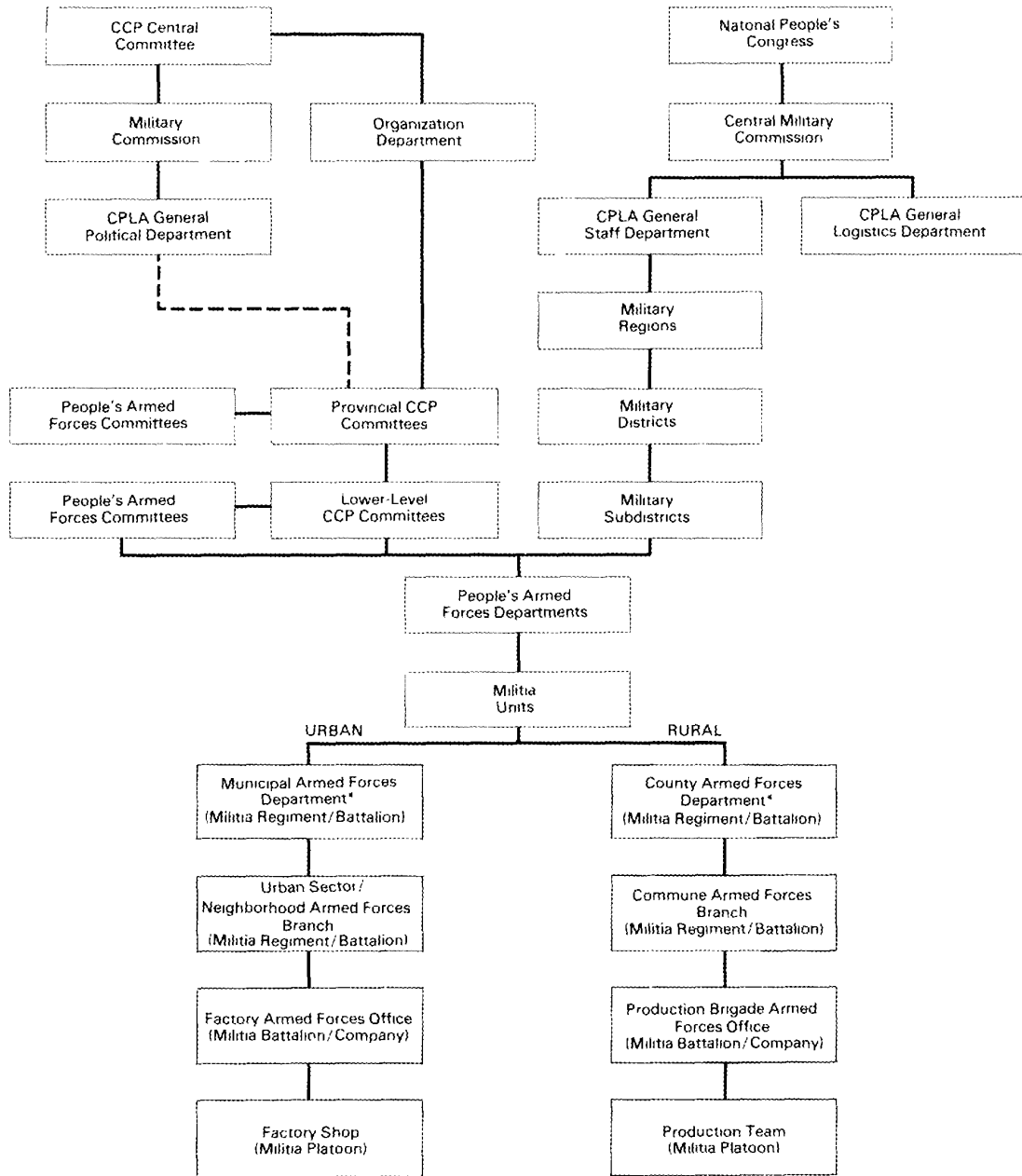

— Policy and Command
 - - - Coordination



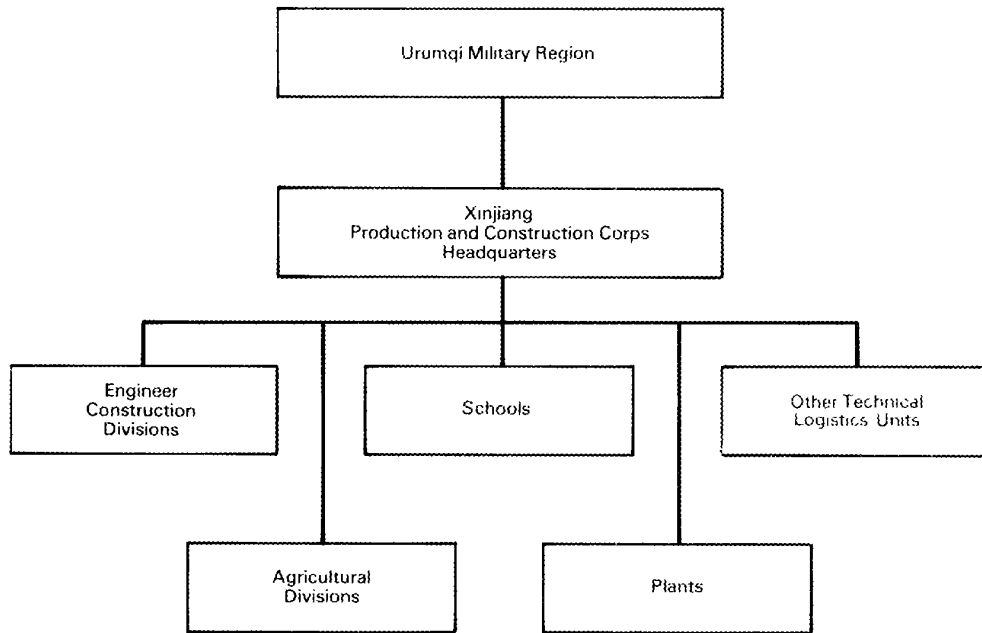

* Militia activity is supervised by county or municipal "People's Armed Forces Department." These departments are probably shared by a mixture of regular CPLA and civilian personnel and are subject to dual control as military bodies. They are subject to the next higher military echelon, the military subdistrict; as political organs, they are subject to the county or municipal party committee, which they serve as a military staff section.

NOTE: Within the various militia units, elements of each of the three militia categories may be found. The armed and basic militia serving primarily as cadres.

Probable Organization of the Xinjiang Production and Construction Corps

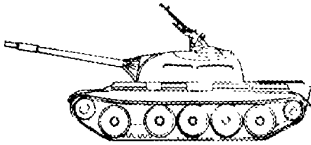
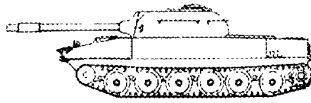

Armored Vehicles

Equipment	Technical Characteristics	Role	Number by Organization	Refer to Appendix	Remarks
Tanks					
Type 62 	Crew: 4 Weight: 21 tons Main armament: 85mm Ammunition: HEAT, APHE, AP, HE, SMK	Recon (light tank)			May be used as a main battle tank in especially rugged terrain, particularly in South China.
Type 63 	Crew: 4 Weight: est 18 tons Main armament: 85mm Ammunition: APHE, HEAT, HE, AP, SMK	Recon (light tank)			Chinese upgunned and enlarged version of Soviet PT 76 amphibious light tank. Armor thickness equivalent to APC. May be used as main battle tank in coastal regions.
T-34/85 	Crew: 4-5 Weight: 32 tons Main armament: 85mm Ammunition: HE, APHE, HVAP, SMK	Main battle tank (medium)			Replaced by Type 59 tank. May be given to local forces.
Type 59 	Crew: 4 Weight: 36 tons Main armament: 100mm Ammunition: APHE, HEAT, HE, SMK	Main battle tank (medium)		C H	Improved Soviet T54A
Type 69 	Crew: 4 Weight: 36 tons Main armament: 100-115mm Ammunition: APFSOS, HEFS	Main battle tank (medium)			Improved Chinese Type 59

Armored Vehicles

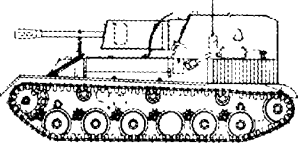
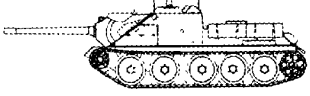
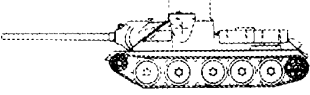
Equipment	Technical Characteristics				Number by Organization	Refer to Appendix	Remarks
	Maximum range (meters)	Ammo	HE proj weight (pounds)	Rate of Fire (rpm)			
Assault Guns SU-76 	13,290	HE APHE HVAP HEAT	14	15-20	}	H	Only a few may be in existence. Supplied by USSR.
SU-85 	15,650	HE APHE AVAP	21	15-20			Only a few may be in existence. Supplied by USSR.
SU-100 	21,000	HE APHE HEAT	35	8-10			Only a few may be in existence. Supplied by USSR.

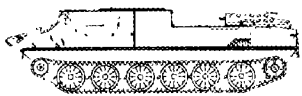
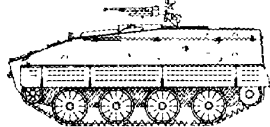
Equipment	Technical Characteristics	Role	Number by Organization	Refer to Appendix	Remarks
Armored Personnel Carriers M-1974 	Crew: 2 Passengers: 20 Weight: 14 tons Tracked	APC			Amphibious, Chinese version Soviet BTR-50.
Type 63 	Crew: 4 Passengers: 10 Weight: 10 tons Armament: 12 7mm MG Tracked	APC	120 Mech Inf Regt.	I	Amphibious; data not available.





Infantry Weapons

Weapons	Caliber	Type of Fire	Weight (kilograms)	Feed	Effective Range (meters)	Practical Rate of Fire	Ammunition	Number by Organization	Remarks
Small Arms									
Pistol, Type 54	7.62mm	Semi-auto	Unloaded 0.769	8 round box magazine	50	30 rpm	7.62x25mm	49 in infantry battalion	Chinese produced copy of Soviet TT-M1933
Pistol, Type 59	9mm	Semi-auto	Unloaded 0.67	8 round box magazine	50	30 rpm	9x18mm		Chinese produced copy of Soviet PM
Carbine, Type 56	7.62mm	Semi-auto	Unloaded 3.85	10 round box magazine	400	35-40 rpm	7.62x39mm (M-1943)	361 in infantry battalion	Copy of Soviet SKS
Rifle, Type 68	7.62mm	Auto or semi-auto	Unloaded 3.9	15 round box magazine	400	Auto: 100 rpm Semi-auto: 40-60 rpm	7.62 x 39mm (M-1943)	180 in airborne battalion	Chinese developed rifle probably replacing Type 56 carbine.
Assault Rifle, Type 56	7.62mm	Auto or semi-auto	Unloaded 2.93	30 round box magazine	400	Auto: 100 rpm Semi-auto: 40 rpm	7.62x39mm (M-1943)	221 in infantry battalion	Chinese produced copy of Soviet AK-47.
Light machinegun, Type 56-1	7.62mm	Auto	Unloaded 6.6	100 round drum	100	150 rpm	7.62x39mm (M-1943)	27 in infantry battalion	Modified copy of Soviet RPD.
Light machinegun, Type 58	7.62mm	Auto	Unloaded 13.0	47 round drum magazine or 250 round belts	1,000	230-250 rpm	7.62x54mm Rimmed (M-1908)	3 in infantry battalion	Copy of Soviet RP-46.
Machinegun, Type 67	7.62mm	Auto or semi-auto	Unloaded 5.0	40 round box magazine or 75 round drum magazine	800	Auto: 150 rpm Semi-auto: 50 rpm	7.62x39mm (M-1943)		A company-level machinegun.
Submachinegun, Type 64	7.62mm								Chinese designed submachinegun. Silenced.
Heavy machinegun, Type 53/57	7.62mm	Auto	Unloaded without tripod 13.5	250 round belts	1,000	250-300 rpm	7.62x54mm Rimmed	6 in infantry battalion	Copy of Soviet Goryunov M-1943 SG/SGM.

Infantry Weapons

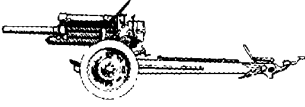
Weapons	Caliber	Type of Fire	Weight (kilograms)	Feed	Effective Range (meters)	Practical Rate of Fire	Ammunition	Number by Organization	Remarks
Small Arms									
Heavy machine-gun, Type 54	12.7mm	Auto	Unloaded 34.0	50 round belts	Ground target: 1,500 Air target: 1,000	80 rpm	Standard 12.7mm	6 in infantry regiment	Copy of Soviet Model DShK M-1938/46.
Mortars									
Mortar, Type 63	60mm		12		Max: 1,530 Min: 200	15-20 rpm		6 in infantry battalion	Chinese designed.
Mortar, Type 53	82mm		56		Max: 3,040 Min: 100	15-25 rpm	Weight: HE 3.05 kg	6 in infantry battalion	Copy of Soviet 182mm Mortar, M-1937.
Antitank									
Grenade launcher, Type 56	Launcher: 40mm Projectile: 80mm		2.86		150	4-6 rpm	HEAT	40 types 56/69 grenade launchers in infantry battalion	Modified copy of Soviet RPG-2.
Grenade launcher, Type 69	Launcher: 40mm Projectile: 85mm		6.3		300-500	4-6 rpm	HEAT		Modified copy of Soviet RPG-7.
Rocket Launcher, Type 70-1	62mm		?		150	4-6 rpm			Chinese designed.
Red Arrow 73 Antitank Guided Missile			11.3		Max: 3,000 Min: 500				Copy of Soviet AT/3A Sagger ATGM.
Recoilless Rifle, Type 36	57mm		20.1		450	15 rpm	HEAT	3 in infantry battalion	Modified US design.
Recoilless Rifle, Type 56	75mm		86.3		640	10 rpm	HEAT	9 in recoilless rifle company, infantry regiment	Standard RL in CPLA units; modified US design.
Recoilless Rifle Type 65	82mm		28.2		450	6 rpm	HEAT		Chinese designed; probably replacing 75mm, Type 56. Lighter version of Soviet B-10.

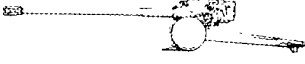
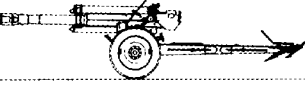
Artillery

Equipment	Technical Characteristics				Number by Organization	Refer to Appendix	Remarks
	Maximum range (meters)	Ammo	HE proj weight (pounds)	Rate of Fire (rpm)			
122mm Howitzer, Type 54 	11,800	HE HEAT	48	5-6	12 in arty regt, inf div 12 in arty regt, armd div 6 in each arty regt, arty div 3 in arty bn, BD div 3 in arty bn, ID div	C H K Q R	Copy of Soviet M-1938.
122mm Gun, Type 60 	24,000	HE APHE	55	6-7	6 in each arty, regt, arty div 6 in each gar regt, gar div	K S	Copy of Soviet D-74.
130mm Field Gun, Type 59-1 	27,000	HE	73.5	5-6	6 in each arty regt, arty div 6 in each gar regt, gar div	K S	Chinese designed. On 122mm Gun Type 60 chassis.
152mm Howitzer 	12,400	HE semi AP	88	3-4	6 in each arty regt, arty div	K	Copy of Soviet M-1943.
152mm Gun-howitzer, Type 66 	17,200	HE APHE	96	5	6 in each arty regt, arty div 6 in each gar regt, gar div	K S	Copy of Soviet D-20. On 122mm Gun Type 60 chassis.
Self-propelled Howitzer (probably 122mm) 	(See 122mm Howitzer, Type 54)						China's first designed and produced self-propelled gun. Believed to be a 122mm Howitzer Type 54 mounted on a Type 63 APC.

Artillery

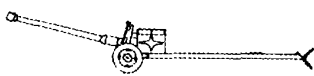



Equipment	Technical Characteristics				Number by Organization	Refer to Appendix	Remarks
Antitank Guns	Point blank range at 2 m high target (m)	Types of Ammo	Armor penetration at 0° (mm)	Rate of Fire (rpm)			
57mm AT Gun, Type 55 	1,100	HE APHE HVAP	140 at 500m	25			
85mm AT Gun, Type 55 	1,150	HE APHE HVAP	130 at 1,000m	15-20			Copy of Soviet D-44



Weapons	Caliber	Weight (kilograms)	Effective Range (meters)	Practical Rate of Fire	Ammunition (kilograms)	Scale of Issue	Remarks
Mortars							
Mortar, Type 55	120mm	275	Max: 5,700 Min: 460	12-15 rpm	Weight: HE: 15.4	Twelve 120/ 160mm mortars in infantry div	Copy of Soviet 120mm mortar, M1943.
Mortar, Type 56	160mm	1,300	Max: 8,040 Min: 750	2-3 rpm	Weight: HE: 41.5		Copy of Soviet 160mm mortar, M160.

Equipment	Technical Characteristics				Number by Organization	Refer to Appendix	Remarks
Multiple Rocket Launchers	Number of tubes	Maximum range (meters)	Warhead weight (pounds)	Reload time (minutes)			
107mm Rocket Launcher Type 63-1 	12	8,050	43	3	18 in Inf div	C	Has cast aluminum tubes and weighs 300 pounds less than the Type 63.

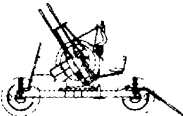

Artillery

Annex 3 to Appendix U (Continued)

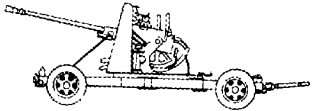
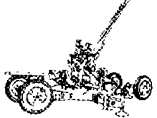
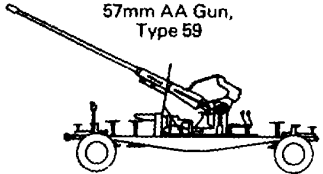
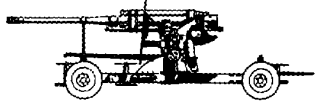

Equipment	Technical Characteristics				Number by Organization	Refer to Appendix	Remarks
	Number of tubes	Maximum range (meters)	Warhead weight (pounds)	Reload time (minutes)			
130mm Rocket Launcher/ Truck Mounted Type 63 	19	9,500	55	5			Chinese designed
130mm Rocket Launcher/ APC Mounted Type 70 	19	9,500	55	5			Chinese designed, tracked
122mm Rocket Launcher BM-21 (Soviet) 	40	20,500	136.4	10			Chinese version of Soviet BM-21
M-1979 Antitank Minelaying Rocket Launcher 	10				4 eng. bat., Inf. div		Modified version of Soviet BM-13 132mm truck chassis

Equipment	Technical Characteristics			Number by Organization	Refer to Appendix	Remarks
	Tactical AA range (meters)	Cyclic rate of fire (rpm)	Fire Control			
14.5mm AAHMG, Type 56 	1,400	600	optic	53 to AAA div 9 in AAA bn, gar div	L T	Towed, four barrels. Copy of Soviet ZPU-4
14.5mm AAHMG, Type 58 	1,400	300	optic	12 in AAA bn, inf div 12 in AAA bn, armd div 10 in AAA bn, arty div 9 in AAA bn, AT arty div 15 in airborne div	C H M G	Towed, two barrels. Copy of Soviet ZPU-2

Artillery

Equipment	Technical Characteristics			Number by Organization	Refer to Appendix	Remarks
	Tactical AA range (meters)	Cyclic rate of fire (rpm)	Fire Control			
37mm AA Gun, Type 55 	2,500	80	optic	18 in AAA bn, inf div 15 in AAA bn, armd div 15 in AAA bn, arty div 15 in AAA bn, AT arty div	C H	Copy of Soviet M1939
37mm AA Gun, Type 65 (dual) 	2,500	80-160	optic		Towed, two barrels	
57mm AA Gun, Type 59 	6,000	70	radar/ optic		K M	Towed, single barrel. Copy of Soviet S60.
85mm AA Gun 	10,000	15-20	radar	40 in AAA Division		Copy of Soviet KS-18.
100mm AA Gun, Type 59 	12,000	15	radar	40 in AAA Division		A standard weapon of air defense units' AAA. Copy of Soviet KS-19.

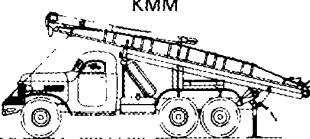
Engineer Equipment

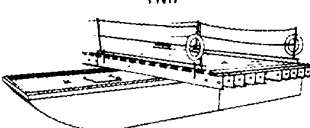
Equipment	Technical Characteristics	Role	Organization	Refer to Appendix	Remarks
Vehicle-launched Bridges T54 MTU 	Load class: 60 Span: 11m Launch time: approx 3 min	Cantilever tank bridge			
KMM 	Load class: 15 Span/unit: 7m Span/set of 5 units: 35m	Truck-launched treadway bridge			
TMM 	Load class: 60 Span unit: 10.4m Span set (4 units): 41.6m	Truck-mounted scissors bridge			
Bridging					
TPP 	Load class: up to 70 Length of bridge: 181m Assembly time: 2m/min	Heavy pontoon bridge	Pontoon bridge regiment	0	
TMP 	Load class: 70 Length of bridge: 90.8m Assembly time: 3 hours	Heavy pontoon bridge	Pontoon bridge regiment	0	

Signal Equipment

Annex 5 to Appendix U

Nomenclature (Alternate Designation)	Frequency (Megahertz)	Type of Emission*	Power (Watts)	Transportability	Using Units	Remarks
Radio Receivers						
A-148	1-15	Not applicable	Not applicable	Manpack Vehicle	Army Division Regiment	Copy of Soviet R-311. Receives A1, A2, and A3 emissions
139 (XS-D14)	2-12.3 (3 bands)	Not applicable	Not applicable	Manpack	Regiment and below	Receives A1, A2, and A3 emissions
239	Unknown	Not applicable	Not applicable			
435 (WS-430, WS-430A)	0.54-32, WS-430 0.54-25, WS-430A	Not applicable	Not applicable	Nil	Military Region	Diversity AM receiving equipment. Cabinet mounted.
7512	1.5-25 (5 bands)	Not applicable	Not applicable	Nil	Military Region	Receives A1, A2, and A3 emissions.
Radio Relay:						
Unknown (R-401, Soviet)	60-69.975	F2, F3, F9	2.5	Vehicle	Army Division Air defense	Provides 2 telephone and 2 telgraph signals on 1 trunk (54 fixed frequencies, 1 at a time). Used for command and administrative nets
Unknown (R-403, Soviet)	60-69.975	F2, F3, F9	2.5	Vehicle	Army Division Air defense	Relay element of R-401.
Unknown (RVG-902, East German)	1200-1460	F9	3.0	Nil	Military Region	Provides 8 voice channels.
Unknown (RVG-903, East German)	1200-1470	F9	9.0	Nil	Military Region	Provides 8 voice channels.
Unknown	131-144	F9	5.0	Nil	Military Region	Provides 6 to 8 voice channels
Radio Sets						
71B (71.71B1)	2.0-7.2 Transmitter 1.9-7.2 Receiver	A1, A3	1.9, A1 1.5, A3	Manpack Vehicle	Regiment and below	
102-E (X D6, 55-B, 55-B1, 156)	2-12	A1, A2, A3	15.0	Manpack Vehicle	Regiment and below	Electronic copy of US AN/GRC-9
103	3.8-6	A1, A3	17.0	Manpack (2-person) Vehicle	Regiment and below	Electronic copy of US SCR-694. In limited use, probable used by airborne forces.
Unknown (A-7-A Soviet)	27-32	F3	1.0	Manpack	Regiment and below	
Unknown (2 watt station)	1.7-3.2 (2 bands) 3.2-6.0	A1, A3	3.5, A1 2.0, A3	Manpack	Company and below	Transistorized set. Chinese designed.
Unknown	40-48	F3	0.5	Vehicle	Regiment and below	

▸ **TYPE OF EMISSION**

Amplitude Modulation (AM):

- A1 -- Manual Morse code, continuous wave (CW)
- A2 -- On-off-keying/modulated manual Morse code (MCW)
- A3 -- Telephone, double sideband, full carrier

Frequency Modulation (FM):

- F1 -- Frequency shift telegraphy, single channel
- F2 -- Frequency modulated Morse code
- F3 -- Telephone
- F9 -- Composite transmission

Signal Equipment

Nomenclature (Alternate Designation)	Frequency (Megahertz)	Type of Emission*	Power (Watts)	Transportability	Using Units	Remarks
Radio Transceivers						
A-130B	35.95-46.15	F3	1.3	Manpack Vehicle	Regiment and below	Infantry set. Copy of Soviet R-105D.
A-211B	28-36.5	F3	1.3	Manpack Vehicle	Regiment and below	Artillery set. Copy of Soviet R-108D.
A-220	20-22.375	F3	17.0	AFV	Regiment and below	Armor set. Copy of Soviet R-113.
A-222	2.8-4.99	A1, A3	90.0, A1 50.0, A3	AFV	Regiment and below	Armor CP set. Copy of Soviet R-112.
58	26-29	A3	0.2	Manpack	Company and below	Used where shortages of 702 transceivers exist.
63 (K63, A-131)	1.5-6 (2 bands)	A1, A3	1.3	Lightweight Manpack	Regiment and below	Chinese designed set with subminiature vacuum tubes and built- in Morse key.
71A	55-65	A1, A3	Unknown	Vehicle, fixed	Unknown	
71C	144-152	A1, A3	Unknown	Unknown	Unknown	
702 (E-459, 702D, Walkie Talkie No. 2)	26.1-37	A3	0.3	Lightweight Manpack	Company and below	Electronic copy of US SCR-194 issued to US Army in 1935.
883 (62)	44.8-50.2	F3	0.25	Manpack	Company and below	Transistorized set.
Unknown	45-50	F1, F3	1.0	Manpack	Company and below	Chinese designed tran- sistorized set. Nets with A-130B and 883 transceivers.
Unknown (R-106, Soviet)	46.1-48.8	A3	0.5	Manpack	Unknown	
Radio Transmitters						
XF-D2	2-12 (3 bands)	A1, A2, A3	75.0	Vehicle	Regimental level	Similar to earlier 601 and 81 transmitters.
81 (102A, 102F)	2-12	A1, A2, A3	15.0	Vehicle	Regimental level	
91	2-16	A1, A2, A3	50.0 150.0 400.0	Vehicle	Division	
601	2-12	A1, A2, A3	75.0	Vehicle	Regimental level	High-power version of 81 transmitter.

* TYPE OF EMISSION

Amplitude Modulation (AM):

- A1 -- Manual Morse code, continuous wave (CW)
- A2 -- On-off-keying/modulated manual Morse code (MCW)
- A3 -- Telephone, double sideband, full carrier

Frequency Modulation (FM):

- F1 -- Frequency shift telegraphy, single channel
- F2 -- Frequency modulated Morse code
- F3 -- Telephone
- F9 -- Composite transmission







Signal Equipment

Nomenclature (Alternate Designation)	Operation -- Type	Range (Kilometers)	Remarks
Telegraph Sets			
57-1B			Chinese character teleprinter
Unknown (ST 35, Soviet)		40-64 field cable 400 open wire	TAPE PRINTER 5-unit code plus start/stop: 382 operations per minute (OPM)
Telephone Sets, Field			
B-600	Magneto	8	Resembles 0743 but smaller
CX-2	Magneto	8	Copy of Soviet TAI-43.
Q-071	Magneto	3.5 (est)	Similar in appearance to US EE-8
0743 (0745)	Magneto	8	Copy of Soviet TAI-43
Unknown	Magneto	Unknown	Housed in plastic case with a webbed shoulder strap. Has provisions for monitoring conversations and for testing line continuity.
Telephone Switchboards			
B-611	Local Battery	10 (est)	Portable, cordless, single position, 10-line field switchboard. Used between divisions and regiments.
JCX-1 (252B, 5421)	Local Battery	10 (est)	Exact copy of Soviet K-10. Ten line monocord field switchboard for command posts.
Unknown	Local or Central Battery	10 (est)	Double cord operated 40 line switchboard. Can be used for conference calls with line or radio subscribers.
Wire, Field			
Unknown	Not applicable	10 (est)	Standard twisted pair wire, stored, dispersed, and retrieved on "H"-shaped frames with capacity of 500 meters. Wire includes 4 strands of steel and 3 strands of copper with polyvinyl sheath. Tensile strength, 200 pounds; 2 to 5 decibel loss per kilometer for voice transmission.



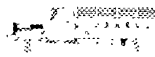

Tracked Tractors

Vehicle	Weight (kilograms)	Maximum Payload (kilograms)	Towed Load (Kilograms)	Cruising Range (kilograms)	Remarks
Artillery Artillery Tractor, Type 59 					Chinese designed and produced heavy artillery tractor.

Load-Carrying Wheeled Vehicles

Trucks	Weight (kilograms)	Maximum Payload (kilograms)	Towed Load (kilograms)	Cruising Range (kilometers)	Remarks
BJ-212, ½-ton Utility Truck 4 x 4 	1,530	425		440	Chinese produced commander's jeep and reconnaissance vehicle.
GAZ-63, 2-ton Cargo Truck, 4 x 4 (Soviet) 	3,200	2,000	2,000	780	Limited number in service. Used as prime mover for mortars and light artillery pieces.
GAZ-51, 2½-ton Cargo Truck, 4 x 2 (Soviet) 	2,500	2,500	2,500	450	Relatively large numbers still in service. Cargo and prime mover use.
ZIL-150, 4½-ton Cargo Truck, 4 x 2 (Soviet) 	3,900	4,000	4,500	500	Relatively large numbers still in service. Cargo and prime mover use.
ZIL-164, 4-ton Cargo Truck, 4 x 2 (Soviet) 	4,100	4,000	6,400	405	Cargo and prime mover use.
CA-10, 4-ton Cargo Truck, 4 x 2 	3,840	3,540		415	Chinese produced version of ZIL-150. Extensively used as cargo carrier.
ZIL-151, 5-ton Cargo Truck, 6 x 6 (Soviet) 	5,580	4,500	3,600	652	Extensively used as prime mover for artillery.
ZIL-157, 2½-ton Cargo Truck, 6 x 6 (Soviet) 	5,800	4,500	3,600	510	Cargo and prime mover.

Load-Carrying Wheeled Vehicles

Trucks	Weight (kilograms)	Maximum Payload (kilograms)	Towed Load (Kilograms)	Cruising Range (kilometers)	Remarks
CA-30, 2½-ton Cargo Truck, 6 x 6 	5,450	4,500	3,600	680	Chinese produced copy of ZIL-157. Cargo and prime mover use.
NJ-230, 1½-ton Cargo Truck, 4 x 4 	3,440	2,100	2,100	500	Chinese produced copy of the Soviet GAZ-63. Cargo and prime mover use.
EQ-240 East Wind Truck, 6 x 6 	7,500	4,000	7,500		Cargo and prime mover.
CQ-260 Red Crag Truck, 6 x 6 	14,500	10,000	15,000	800	Prime mover.

Chemical Equipment

Equipment	Technical Characteristics	Organization	Refer to Appendix	Remarks
Flamethrowers				
ROKS-3	Flamethrower, manpack	Inf div	C	Possibly replaced by LPO type.
LPO	Flamethrower, manpack	Inf div	C	Soviet design.
TPO	Flamethrower, cart mounted	Inf div	C	
FO	Flamethrower, emplaced type	inf div	C	Electrically controlled, usually in groups of three or five, in defensive operations
Smoke Munitions				
DB-11	Smoke barrel	Chemical warfare bn, army. Chemical warfare co. inf div.	B C	For use in large-scale smokescreens, Soviet design
DM-11	Smoke pot			Soviet design.
Decontaminants and Equipment				
PM-DK	Decontamination kit for mortars, machineguns, and grenade launchers. Contains liquid decontaminant.	Chemical warfare bn, army. Chemical warfare co. inf div.	B C	Soviet design.
RDP-4	Decontamination apparatus, manpack for small arms and equipment.	Chemical warfare bn, army. Chemical warfare co. inf div.	B C	Soviet design.
RDP-3	Decontamination apparatus, manpack for small arms and equipment.	Chemical warfare bn, army. Chemical warfare co. inf div.	B C	Soviet design.
ARS-12	Decontamination apparatus, truck mounted, for weapons, vehicles, other equipment, and terrain.	Chemical warfare bn, army. Chemical warfare co. inf div.	B C	Soviet design.
ADM-48	Decontamination apparatus, truck mounted, for weapons, vehicles, other equipment, and terrain.	Chemical warfare bn, army. Chemical warfare co. inf div.	B C	Soviet design.

Chinese Naval Vessels

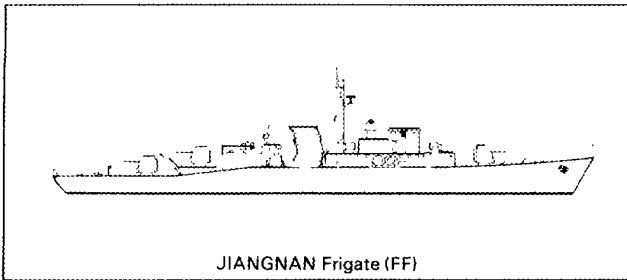

JIANGNAN Frigate (FF)

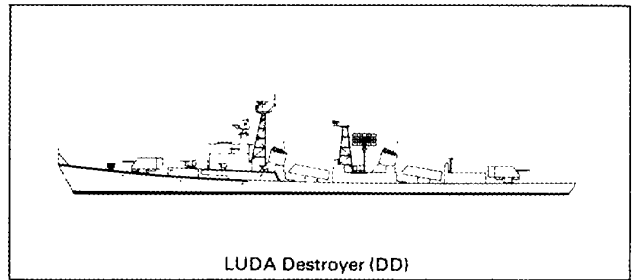

LUDA Destroyer (DD)

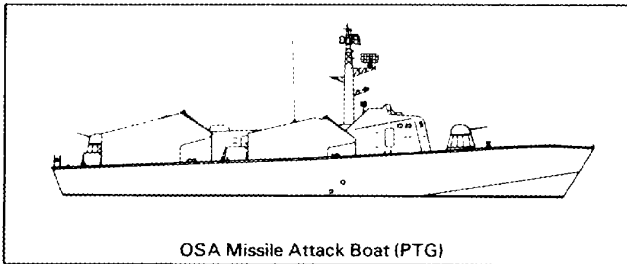

OSA Missile Attack Boat (PTG)

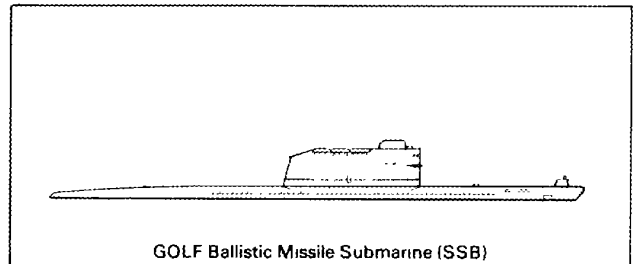

GOLF Ballistic Missile Submarine (SSB)

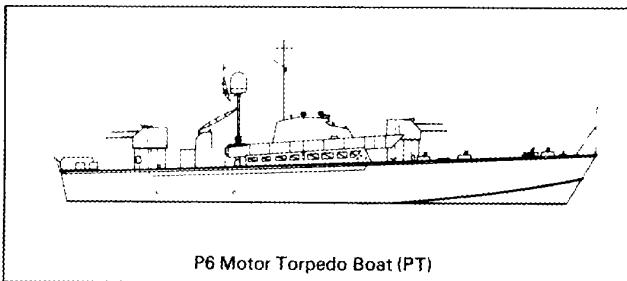

P6 Motor Torpedo Boat (PT)

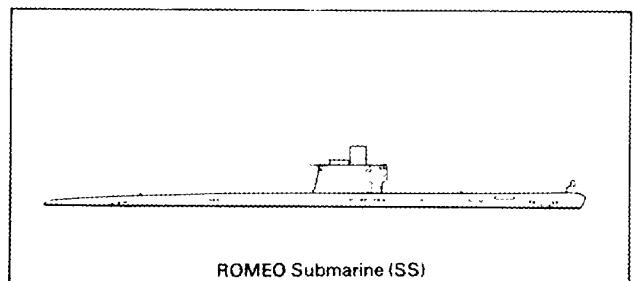

ROMEO Submarine (SS)

Air Force Inventory

Aircraft	Role	Length	Wing Span or Rotor Diameter	Engines	Range (nautical miles)	Radius (nautical miles)	Max Speed (knots)	Mission Payload
Bombers								
B-6/BADGER/Tu-16	Intermediate range bomber	116'	108'	2 turbojet	3,200	1,650	510	Normal 6,600 lbs
BULL/Tu-4	Intermediate range bomber	99'	141'	4 turboprop	3,050	1,550	225 cruise	Normal 10,000 lbs
B-5/BEAGLE/IL-28	Medium range bomber	58'	70'6"	2 turbojet	1,000	550	504	Normal 2,200 lbs
BAT/Tu-2	Medium range bomber	45'6"	62'	2 piston	1,040		208	Normal 3,300 lbs
Fighters								
FAGOT/MiG-15	Fighter bomber	33'	33'	1 turbojet		150	585	Cannon, Two 550 lb bombs*
F-6/FARMER/MiG-19	Interceptor	34'	30'	2 turbojet	1,150	530	650	Cannon Two missiles
F-7/FISHBED/MiG-21	Interceptor	44'	24'	1 turbojet	850	360	Mach 2	Cannon
A-5/FANTAN	Fighter bomber	50'	33'	2 turbojet		430	Mach 1	Cannon, Four 550-lb bombs. Two missiles.
Transports								
CLASSIC/IL-62	Long range transport	160'6"	141'7"	4 turbofan	5,900		495	58,900 lbs*
BOEING 707	Long range transport	152'11"	145'9"	4 turbofan	6,493		521	91,390 lbs*
COOKPOT/Tu-124	Medium range transport	100'	84'	2 turbofan	1,242		432 cruise	13,230 lbs
COOT/IL-18	Medium range transport	118'	123'	4 turboprop	2,690		350 cruise	30,825 lbs
Y-8/CUB/An-12	Medium range transport	109'	125'	4 turboprop	1,832		313 cruise	44,090 lbs
HS TRIDENT 1E	Medium range transport	114'9"	95'	3 turbofan	2,120		520 cruise	24,000 lbs*
HS TRIDENT 2E	Medium range transport	114'9"	98'	3 turbofan	2,120		520 cruise	26,800 lbs*
HS TRIDENT 3B	Medium range transport	131'2"	98'	2 turbofan 1 turbojet	1,780		525	35,357 lbs*
VICKERS VISCOUNT	Medium range transport	85'5"	94'	4 turboprop	1,500		301 cruise	14,500 lbs
CAB/LI-2	Short range transport	64'5"	94'6"	2 piston	1,100		145 cruise	6,600 lbs
COACH/IL-12	Short range transport	90'	104'	2 piston	1,300		175	4,750 lbs
Y-7/COKE/An-24	Short range transport	77'	96'	2 turboprop	1,295		243 cruise	12,566 lbs
Y-5/COLT/An-2	Short range transport	43'	59'8"	1 piston	488		108 cruise	3,000 lbs
CRATE/IL-14	Short range transport	70'	104'	2 piston	1,169		175 cruise	9,000 lbs
CURL/An-26	Short range transport	77'	96'	2 turbofan	1,348		243 cruise	11,023 lbs
CURTISS COMMANDO	Short range transport	108'1"	76'4"	2 piston	1,000	500	160 cruise	7,500 lbs
DOUGLAS SKYTRAIN	Short range transport	64'6"	94'6"	2 piston	1,100	700	145 cruise	6,600 lbs
Helicopters								
HOOK/Mi-6	Heavy	109'	115'	2 shaft turbine	335		162	24,455 lbs
HIP/Mi-8	Medium	60'	70'	2 shaft turbine	229		119	8,818 lbs
HOUND/Mi-4	Medium	55'	69'	1 piston	269		100	3,525 lbs
SA 321 SUPER FRELON	Medium	65'11"	62'	3 turboshaft	442		148	11,023 lbs
US Bell 212	Medium	42'	48'	2 turbolift	227		120	5,000 lbs
SA-365N DAUPHIN 2	Medium	44'	38'	2 turbolift	300		170	2,750 lbs

* Maximum payload

Representative Air Force Aircraft Silhouettes

Bombers

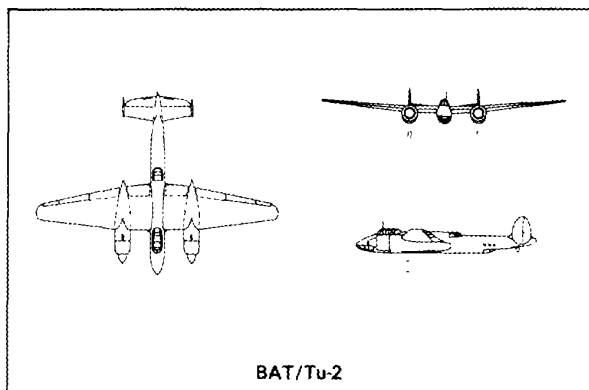
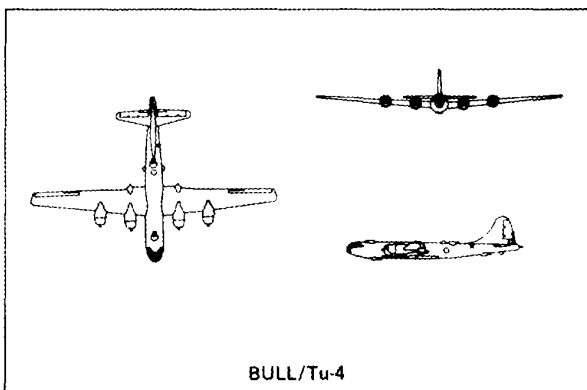
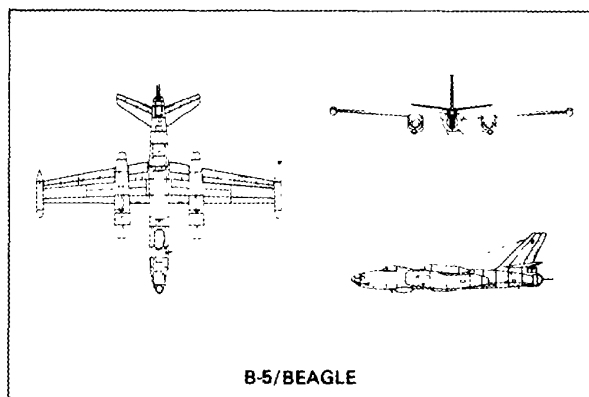
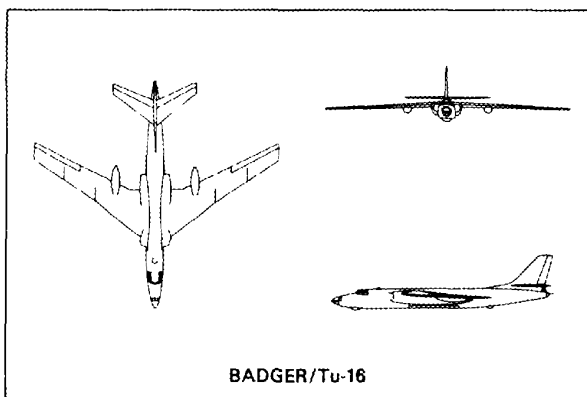

Fighters

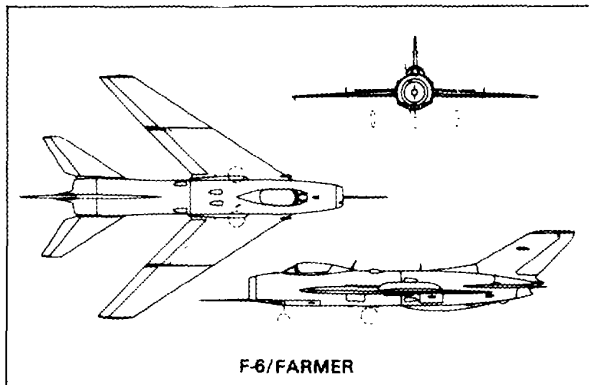
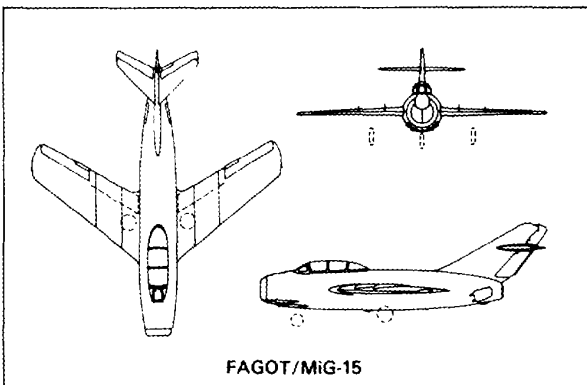

Representative Air Force Aircraft Silhouettes

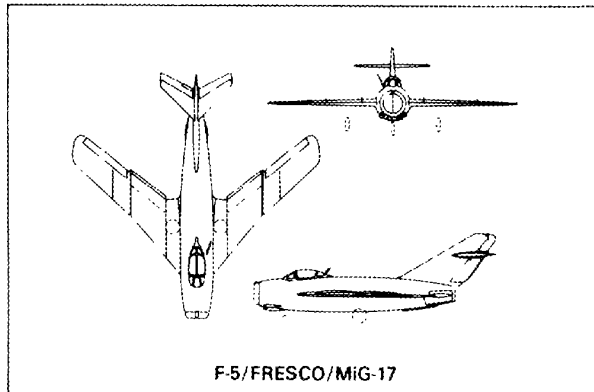

F-5/FRESCO/MiG-17

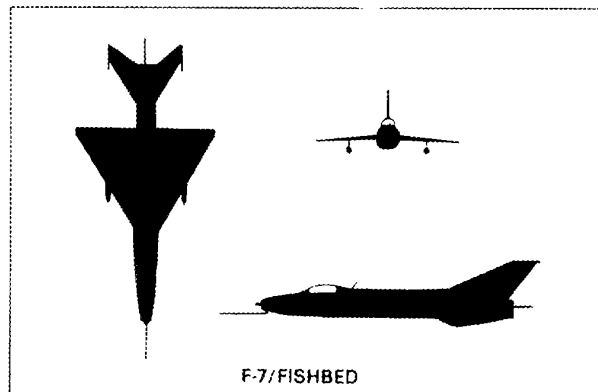

F-7/FISHBED

Transports

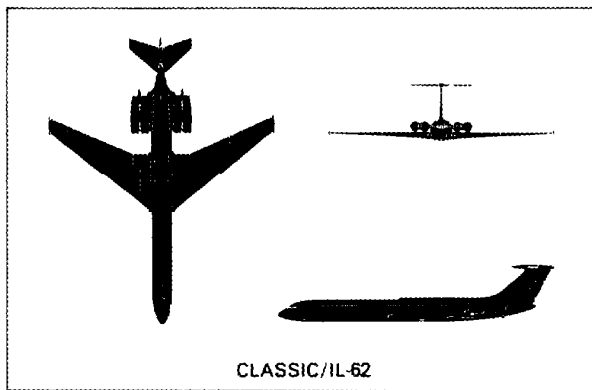

CLASSIC/IL-62

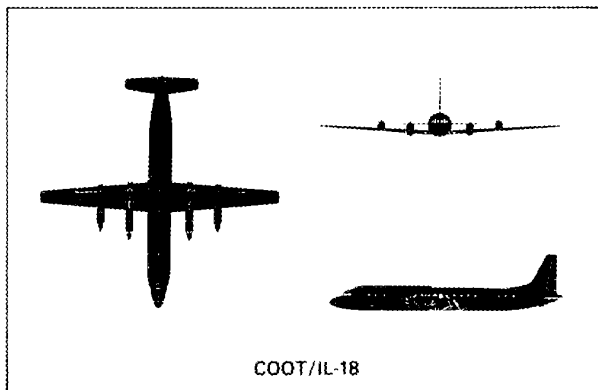

COOT/IL-18

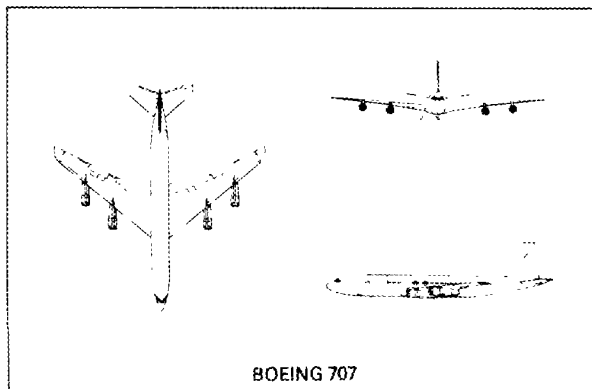

BOEING 707

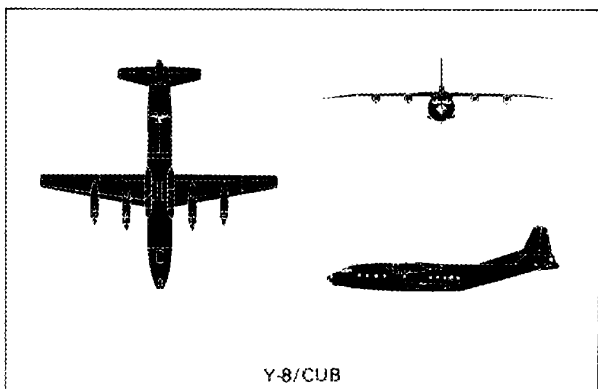

Y-8/CUB

Representative Air Force Aircraft Silhouettes

Appendix X (Continued)

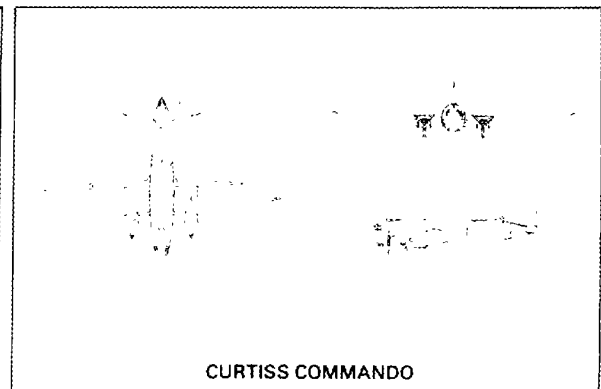
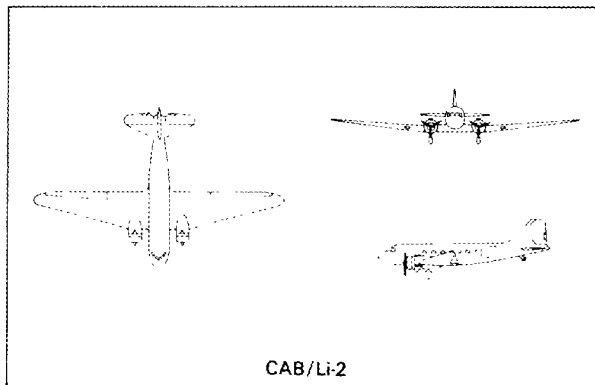
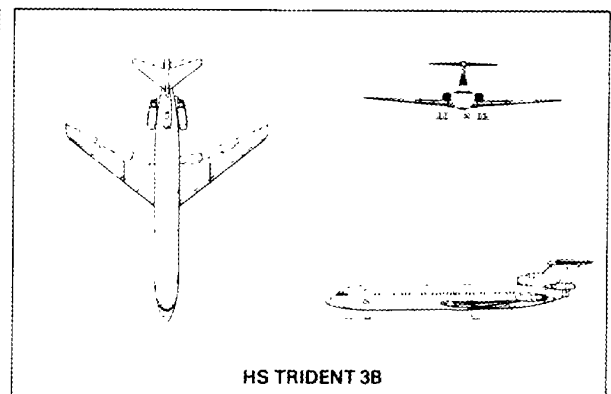
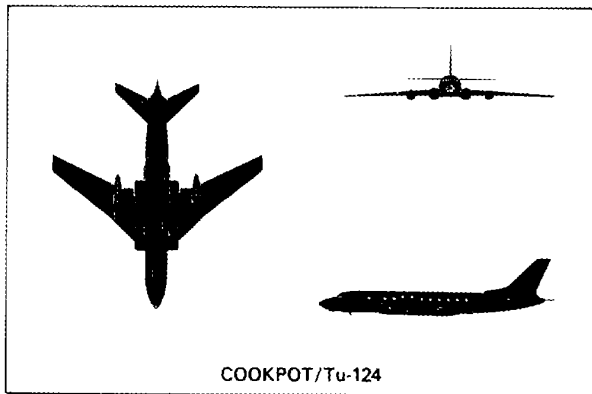
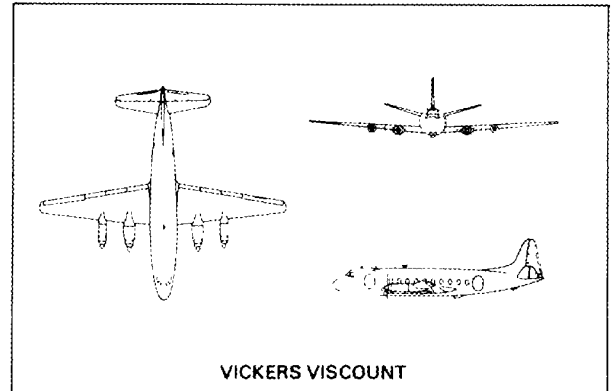
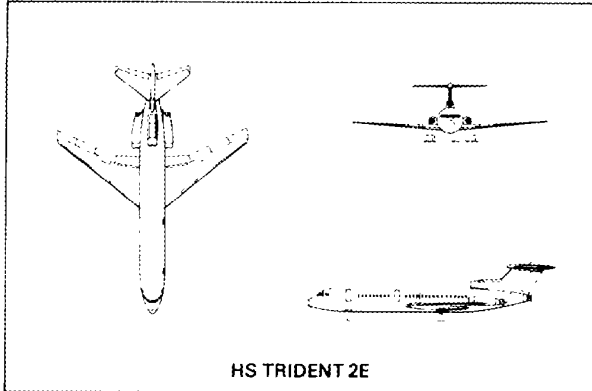

Representative Air Force Aircraft Silhouettes

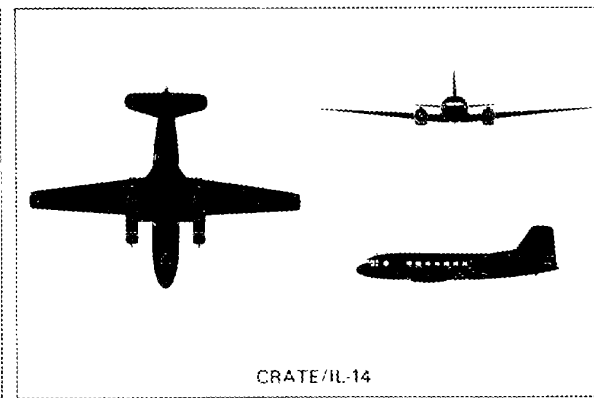
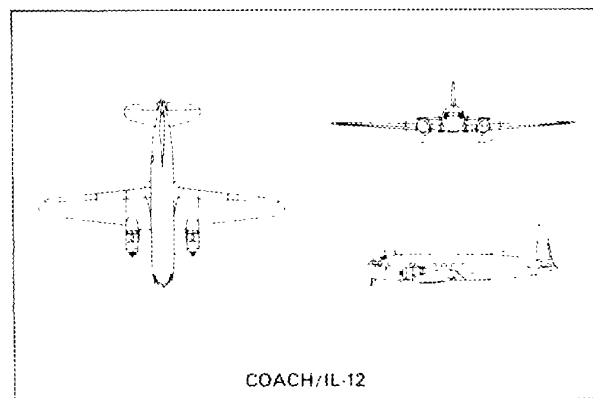
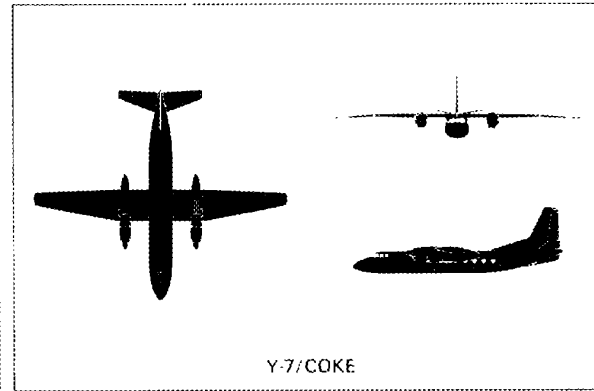
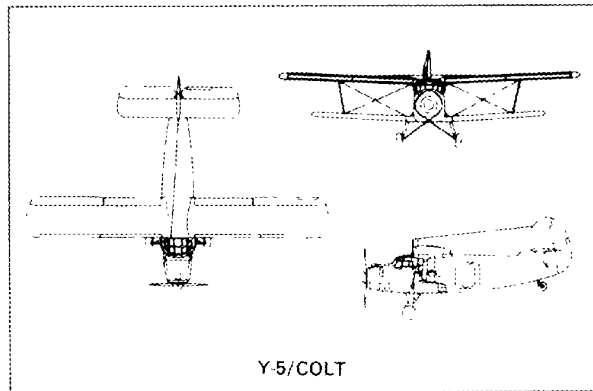
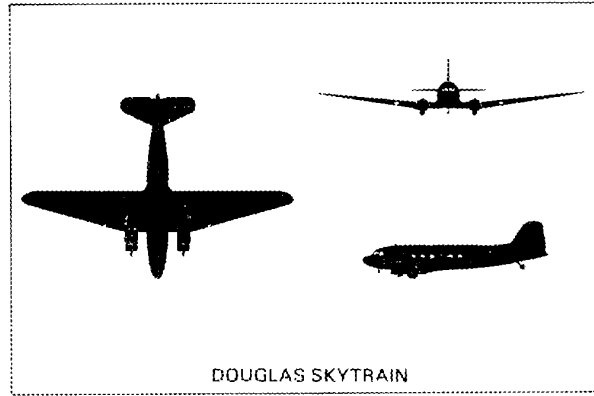
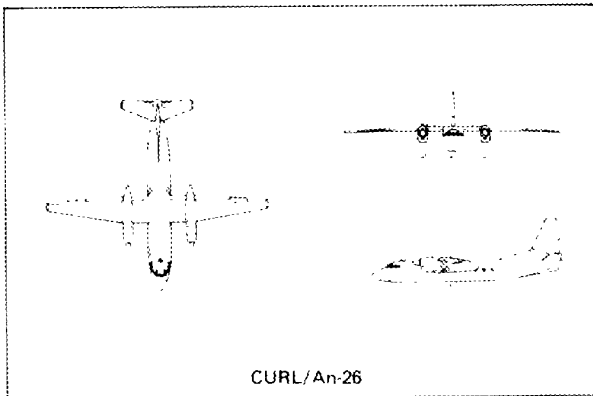

Representative Air Force Aircraft Silhouettes

Helicopters

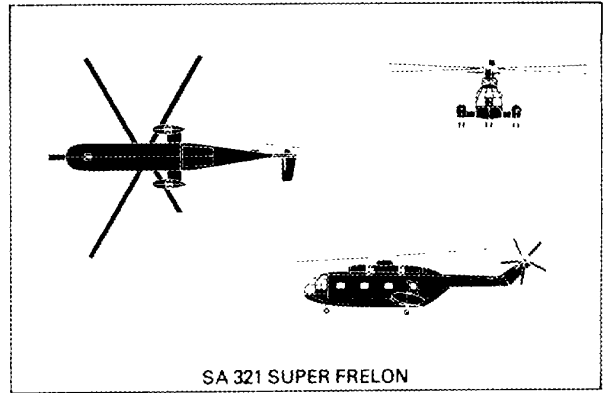
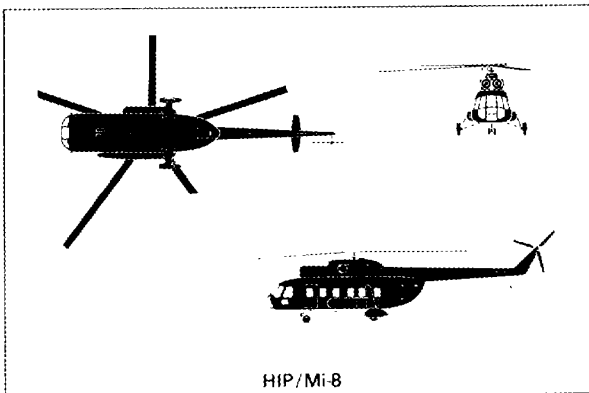
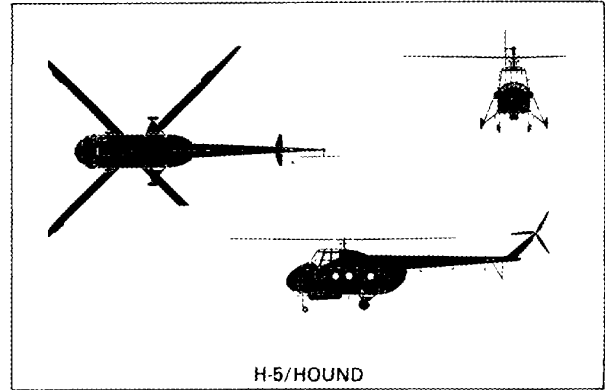
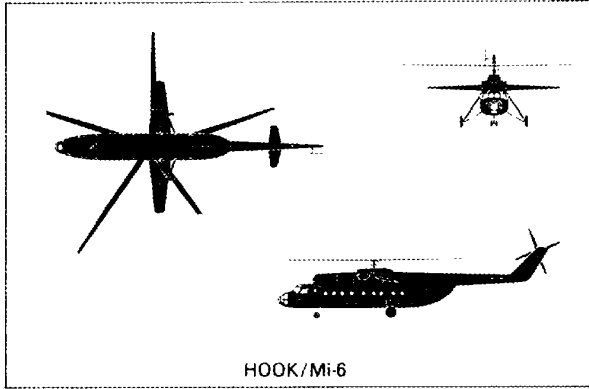

Chinese Ballistic Missile Type and Probable Characteristics

Chinese Designation	Western Designation	Type	First Tested	Range/Perigee	Probable Payload	Propellant
DF-1	SS-2 variant	SRBM (single stage)	1960	several hundred km	unknown	liquid
DF-2	CSS-1	MRBM (single stage)	1966	1,200 km	15 kt	liquid
DF-3	CSS-2	IRBM (single stage)	1969	about 3,000 km	1,000-3,000 kt	storable liquid (probably N2O4/UDMH)
DF-4	CSS-3	ICBM (probable two-stage version of DF-3)	1970	about 7,000 km	1,000-3,000 kt	storable liquid
DF-5	CSS-4	ICBM (two-stage)	1980	about 15,000 km	4,000-5,000 kt	storable liquid (same as DF-3)
CZ-1	CSL 1	Booster variant of DF-4 (three-stage)	1970	265 km orbit	273 kg	storable liquid
CZ-2*	CSL-2	Booster variant of DF-5	1975	150 km orbit	2,650 kg	storable liquid
CZ-3	CSL-3	Three-stage variant of CZ-2	1984	unknown geosynchronous orbit	10,000 kg	storable liquid
Unknown	PRC SLBM	SLBM (two-stage)	1982	about 2,000 km	500-1,000 kt	solid

* The FENGBAO (Tempest)-1 (FB-1) designation applied to this system may refer to the first stage only. It is uncertain as to whether the Chinese designation for the CSL-2 is CZ-2 or FB-1.

